

# **EBARA END SUCTION VOLUTE PUMP MODEL GS**

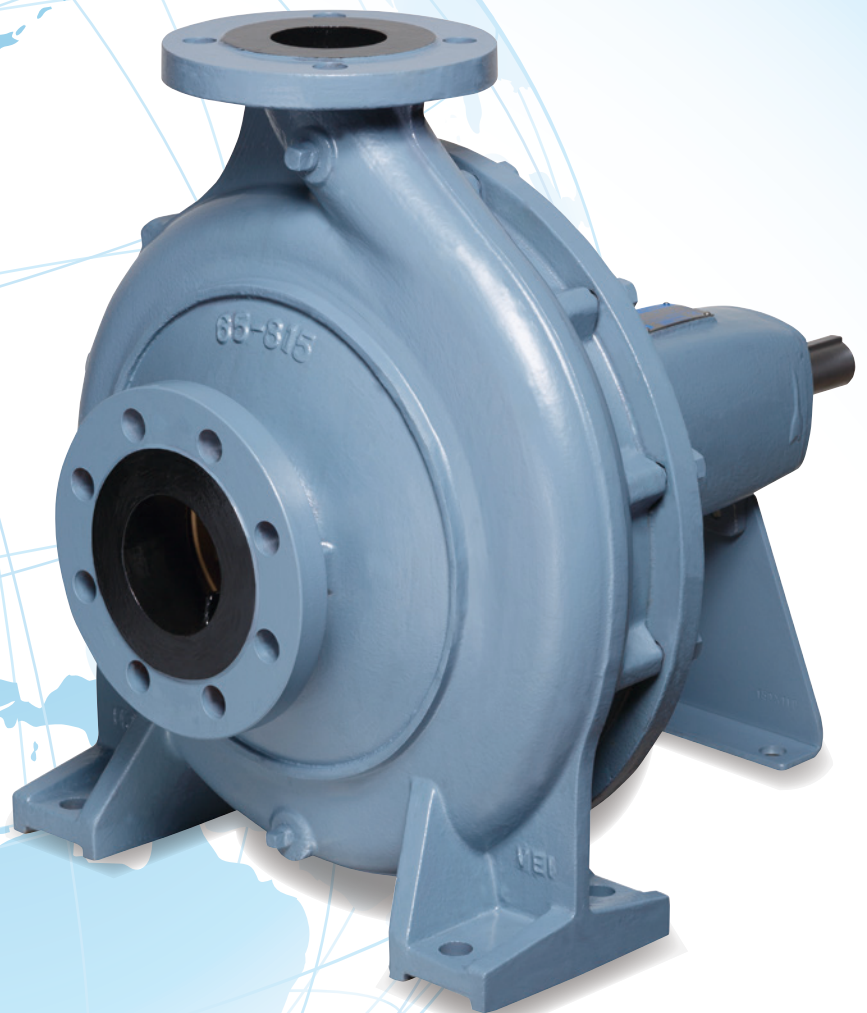

**SPECIFICATION**

Main Applications	A-1
Product Features	A-2
General Description	A-3
Design Details	A-4
Designation	A-5
Applicable Model	A-6

**TECHNICAL DATA**

Impeller Diameter	B-1
Shaft No. and Shaft Diameter	B-2
Maximum Allowable Pressure	B-3
Interchangeability Chart	B-4
Nominal Dimension of Parts	B-5
Noise Data	B-6

**DIMENSIONS**

Dimensions of Bare Shaft Pump	C-1,2
Dimensions of Pump with motor (Fig.)	C-3
Dimensions of Pump with motor (2P)	C-4,5,6
Dimensions of Pump with motor (4P)	C-7,8,9,10,11

**CONSTRUCTION**

Sectional View(Mechanical Seal Type)	D-1
Sectional View(Gland Packing Type)	D-2
Materials of Constructions	D-3,4
Availability of Materials	D-5
Selection of Shaft Seal	D-6

**SELECTION CHART**

50Hz – 2900 min <sup>-1</sup>	E-1
50Hz – 1450 min <sup>-1</sup>	E-2
60Hz – 3500 min <sup>-1</sup>	E-3
60Hz – 1750 min <sup>-1</sup>	E-4

**PERFORMANCE CURVES****50Hz – 2900 min-1**

GS32-125.1, GS 32-160.1, GS 32-200.1,  
GS32-125, GS32-160, GS32-200, GS32-250,  
GS40-125, GS40-160, GS40-200, GS40-250, GS40-315,  
GS50-125, GS50-160, GS50-200, GS50-250, GS50-315,  
GS65-125, GS65-160, GS65-200, GS65-250, GS65-315,  
GS80-160, GS80-200, GS80-250, GS80-315L,  
GS100-160, GS100-200, GS100-250, GS100-315L,  
GS125-200, GS 125-250L, GS 125-315,  
GS150-200, GS150-250,

**50Hz – 1450 min-1**

GS32-125.1, GS 32-160.1, GS 32-200.1,  
GS32-125, GS32-160, GS32-200, GS32-250,  
GS40-125, GS40-160, GS40-200, GS40-250, GS40-315,  
GS50-125, GS50-160, GS50-200, GS50-250, GS50-315,  
GS65-125, GS65-160, GS65-200, GS65-250, GS65-315,  
GS80-160, GS80-200, GS80-250, GS80-315, GS80-400,  
GS100-160, GS100-200, GS100-250, GS100-315, GS100-400,  
GS125-200, GS 125-250, GS 125-315, GS 125-400, GS 125-500,  
GS150-200, GS150-250, GS150-315, GS150-400, GS150-500,  
GS200-400, GS200-500,

**60Hz – 3500 min-1**

GS32-125.1, GS 32-160.1, GS 32-200.1,  
GS32-125, GS32-160, GS32-200, GS32-250,  
GS40-125, GS40-160, GS40-200, GS40-250,  
GS50-125, GS50-160, GS50-200, GS50-250,  
GS65-125, GS65-160, GS65-200, GS65-250,  
GS80-160, GS80-200, GS80-250,  
GS100-160, GS100-200, GS100-250L,  
GS125-200, GS 125-250L,  
GS150-200,

**60Hz – 1750 min-1**

GS32-125.1, GS 32-160.1, GS 32-200.1,  
GS32-125, GS32-160, GS32-200, GS32-250,  
GS40-125, GS40-160, GS40-200, GS40-250, GS40-315,  
GS50-125, GS50-160, GS50-200, GS50-250, GS50-315,  
GS65-125, GS65-160, GS65-200, GS65-250, GS65-315,  
GS80-160, GS80-200, GS80-250, GS80-315, GS80-400,  
GS100-160, GS100-200, GS100-250, GS100-315, GS100-400,  
GS125-200, GS 125-250, GS 125-315, GS 125-400, GS 125-500,  
GS150-200, GS150-250, GS150-315, GS150-400L, GS150-500,  
GS200-400, GS200-500,

**BUILDING****• Air conditioning-District heating & cooling**

General water supply  
Brine (antifreeze liquid)  
Hot water circulation  
High boost pressure

**WATER SUPPLY**

- **Water supply duties for municipalities**
- **Irrigation**
- **Drainage clean water**
- **Fire protection**
- **Swimming pool**

**GENERAL INDUSTRY****• Semiconductor Industry**

Pure water

**• Food industry**

General water (Cooling water, Recycling water, Filtered water)  
CIP (Cleaning in Place) , below 50°C and below conc. of 20%

**• Pulp and Paper Industry**

White water (below pulp conc.of 0.3%)

**• Automobile industry**

Water (without slurry)  
Detergent (without slurry)

**• Steel industry-Non-ferrous metals industry**

Coolant  
Cooling Water

**• Garbage incineration**

Cooling Water  
Deaerater  
Condensate water

## Product Features

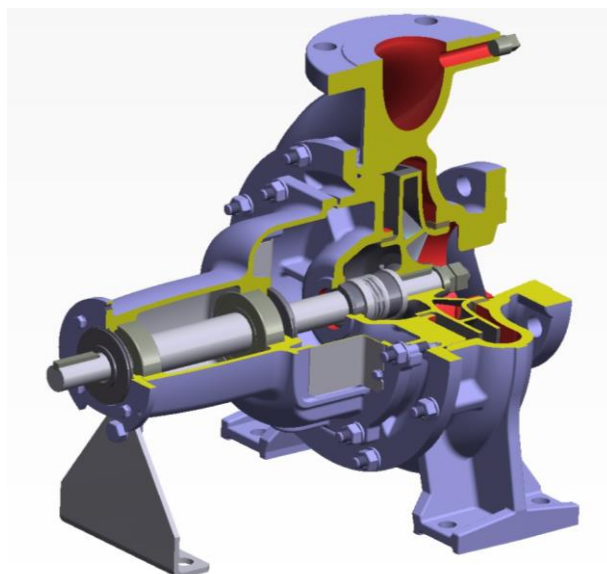

### Energy-saving Design

- World top class pump efficiency achieved.
- Major improvement over our previous models by impeller designed using our proprietary 3D inverse design technology.
- Higher efficiency means lower energy consumption and motor output, and more compact size.

### Simple Maintenance

- Back pull-out structure enables disassembly and inspection without removal of suction and discharge piping.
- Shield bearings eliminate need for adding or exchanging lubricating oil.
- Shaft seal flushing and quenching piping not required for the standard application.
- Air-bleeding not required.
- Simplified bearings and shaft seal enable easy assembly.

### Pump Specifications

- Maximum operating pressure: 25 bar
- Liquid temperature range expansion : -10°C to 140°C
- Compatible with multiple flange standards.
- Able to meet customer specifications with many combinations of shaft seals and materials.

### International Standards

- Pump dimensions adopt EN733
- Mechanical seal adopts EN12756
- Protector fitted in accordance with EN294.

**SPECIFICATION - General Description**

Capacities	To 1300 m <sup>3</sup> /hr (50Hz)
	To 1500 m <sup>3</sup> /hr (60Hz)
Heads	To 150 m (50Hz)
	To 150 m (60Hz)
Liquid temperatures	-10°C to 140°C
Max.working pressures	Up to 25Bar (2.5MPa)
Materials	Casing: Cast Iron , Ductile Cast Iron Impeller: Cast Iron , Ductile Cast Iron , Bronze, Stainless Steel
Standards	EN733
Rotation	Clockwise viewed from coupling end

**FEATURES**

- Horizontal foot mounting
- Back pull-out design
- Single-stage
- Radially split volute casing

**APPLICABLE FLANGE STANDARD**

- EN PN16
- EN PN25
- JIS 10K
- JIS 20K

**IMPELLER TYPE**

- Closed, single suction type and balancing holes to reduce axial thrust

**SHAFT SEAL**

- Gland packing
- Single mechanical seal based upon DIN24960 (Conical type)
- Single mechanical seal (Cylindrical type)
- Double mechanical seal (Cylindrical type)

**BEARINGS AND LUBRICATION**

- Shield ball bearing (Grease lubrication)

**PAINTING**

**1. Outer Surface**

**• Standard up to 120°C**

Primer coating	Epoxy based painting (Cationic electro-deposition; Cation)
Final coating	Alkyd resin based enamel
Finish color	Munsell 2.5PB4/2 (Dark gray)

**• Standard above 120°C up to 140°C**

Primer coating	Epoxy based painting (Cationic electro-deposition; Cation)
Final coating	Non painting
Finish color	Black

**2. Inner Surface**

**• Standard up to 140°C**

Primer coating	Epoxy based painting (Cationic electro-deposition; Cation)
Final coating	Non painting
Finish color	Black

**SPECIFICATION – Designation**

The following designation is system according to EN733.

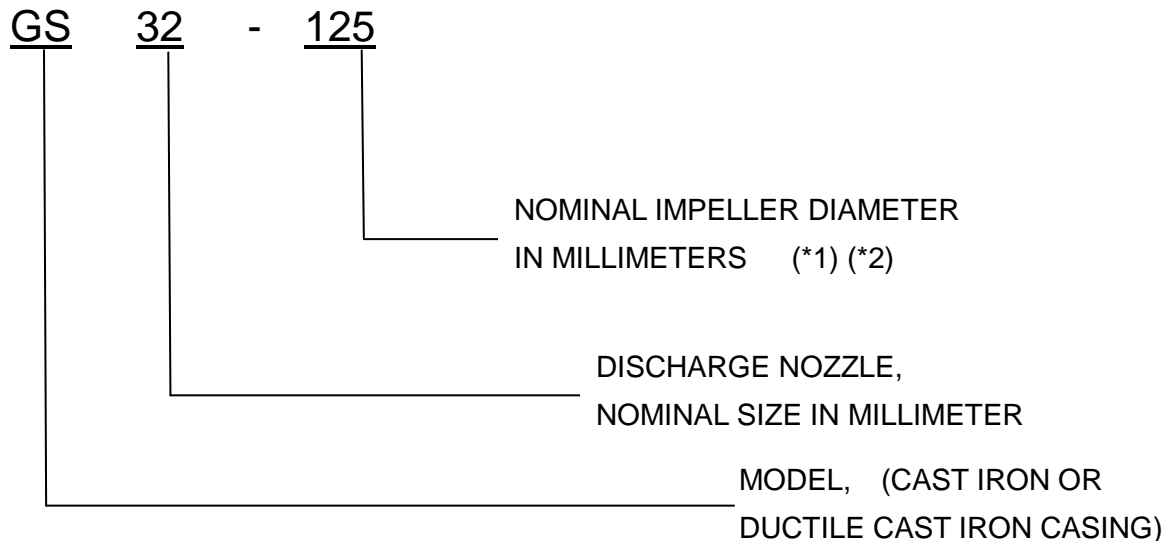

(\*1) The letter “L” following the impeller classification code indicates different bearing designs. To give an example, GS80-315 and GS80-315L have different bearing designs and shaft size.

(\*2) The letter “.1” following the impeller classification code indicates different casing and impeller designs. To give an example, GS32-125 and GS32-125.1 have different casing and impeller designs from one another.



**SPECIFICATION - Applicable Model**

● : Applicable

Model	Shaft No.	50Hz		60Hz		Remarks
		2900 mim <sup>-1</sup> (2 Pole)	1450 mim <sup>-1</sup> (4 Pole)	3500 mim <sup>-1</sup> (2 Pole)	1750 mim <sup>-1</sup> (4 Pole)	
GS32-125.1	230	●	●	●	●	different hydraulic design each other
GS32-125	230	●	●	●	●	
GS32-160.1	230	●	●	●	●	different hydraulic design each other
GS32-160	230	●	●	●	●	
GS32-200.1	230	●	●	●	●	different hydraulic design each other
GS32-200	230	●	●	●	●	
GS32-250	230	●	●	●	●	
GS40-125	230	●	●	●	●	
GS40-160	230	●	●	●	●	
GS40-200	230	●	●	●	●	
GS40-250	230	●	●	●	●	
GS40-315	240	●	●	—	●	
GS50-125	230	●	●	●	●	
GS50-160	230	●	●	●	●	
GS50-200	230	●	●	●	●	
GS50-250	230	●	●	●	●	
GS50-315	240	●	●	—	●	
GS65-125	230	●	●	●	●	
GS65-160	230	●	●	●	●	
GS65-200	230	●	●	●	●	
GS65-250	240	●	●	●	●	
GS65-315	240	●	●	—	●	
GS80-160	230	●	●	●	●	
GS80-200	240	●	●	●	●	
GS80-250	240	●	●	●	●	
GS80-315	240	—	●	—	●	same hydraulic design and different shaft no. each other
GS80-315L	250	●	—	—	—	
GS80-400	250	—	●	—	●	
GS100-160	240	●	●	●	●	
GS100-200	240	●	●	●	●	
GS100-250	240	●	●	—	●	same hydraulic design and different shaft no. each other
GS100-250L	250	—	—	●	—	
GS100-315	240	—	●	—	●	same hydraulic design and different shaft no. each other
GS100-315L	250	●	—	—	—	
GS100-400	250	—	●	—	●	
GS125-200	240	●	●	●	●	
GS125-250	240	—	●	—	●	same hydraulic design and different shaft no. each other
GS125-250L	250	●	—	●	—	
GS125-315	250	●	●	—	●	
GS125-400	250	—	●	—	●	
GS125-500	260	—	●	—	●	
GS150-200	240	●	●	●	●	
GS150-250	250	●	●	—	●	
GS150-315	250	—	●	—	●	
GS150-400	250	—	●	—	—	same hydraulic design and different shaft no. each other
GS150-400L	260	—	—	—	●	
GS150-500	270	—	●	—	●	
GS200-400	270	—	●	—	●	
GS200-500	280	—	●	—	●	

— Not applicable Model

Unit : mm

Model	Shaft No.	50Hz				60Hz			
		2P		4P		2P		4P	
		Max	Min	Max	Min	Max	Min	Max	Min
GS32-125.1	230	140	100	140	100	140	100	140	100
GS32-125	230	142	106	142	106	142	106	142	106
GS32-160.1	230	177	126	177	126	177	126	177	126
GS32-160	230	177	139	177	139	177	139	177	139
GS32-200.1	230	207	172	207	172	207	172	207	172
GS32-200	230	219	175	219	170	219	175	219	170
GS32-250	230	262	198	262	198	262	198	262	198
GS40-125	230	142	105	142	105	142	105	142	105
GS40-160	230	177	134	177	134	177	134	177	134
GS40-200	230	219	172	219	172	219	172	219	172
GS40-250	230	260	211	260	211	260	211	260	211
GS40-315	240	338	265	344	273	—	—	344	273
GS50-125	230	144	111	144	111	144	111	144	111
GS50-160	230	177	131	177	131	177	131	177	131
GS50-200	230	219	171	219	171	219	171	219	171
GS50-250	230	270	210	270	210	237	210	270	210
GS50-315	240	324	277	344	277	—	—	344	277
GS65-125	230	147	120	147	120	147	120	147	120
GS65-160	230	177	135	177	135	177	135	177	135
GS65-200	230	219	162	219	162	215	162	219	162
GS65-250	240	273	215	273	215	273	215	273	215
GS65-315	240	320	258	320	261	—	—	320	261
GS80-160	230	177	147/127	177	147/127	177	147/127	177	147/127
GS80-200	240	222	170/159.2	222	170/159.2	215	170/159.2	222	170/159.2
GS80-250	240	270	220	270	220	247	218	270	220
GS80-315	240	—	—	334	262	—	—	334	262
GS80-315L	250	334	265	—	—	—	—	—	—
GS80-400	250	—	—	438	335	—	—	438	335
GS100-160	240	183	149	183	149	181	149	181	149
GS100-200	240	220	171	220	171	220	171	220	171
GS100-250	240	265	210	270	210	—	—	270	210
GS100-250L	250	—	—	—	—	270	210	—	—
GS100-315	240	—	—	312	242	—	—	312	242
GS100-315L	250	312	242	—	—	—	—	—	—
GS100-400	250	—	—	412	320	—	—	412	320
GS125-200	240	224	174	224	174	201	174	221	174
GS125-250	240	—	—	274	213	—	—	274	213
GS125-250L	250	274	213	—	—	242	205	—	—
GS125-315	250	309	259	334	259	—	—	334	259
GS125-400	250	—	—	424	329	—	—	424	329
GS125-500	260	—	—	511	396	—	—	511	396
GS150-200	240	224/196.5	181/145.3	224/196.5	181/145.3	213/184.2	181/145.3	224/196.5	181/145.3
GS150-250	250	250	213	274	213	—	—	274	213
GS150-315	250	—	—	352	273	—	—	352	273
GS150-400	250	—	—	411	319	—	—	—	—
GS150-400L	260	—	—	—	—	—	—	411	319
GS150-500	270	—	—	511	396	—	—	511	396
GS200-400	270	—	—	420	326	—	—	420	326
GS200-500	280	—	—	530	411	—	—	530	411

**TECHNICAL DATA – Shaft No. and Shaft Diameter**

Model	Shaft No.	At Coupling (mm)	At Radial Bearing (mm)	At Thrust Bearing (mm)	Under Shaft Sleeve (mm)	Sleeve Dia. (For Gland packing) (mm)
GS32-125.1	230	24	30	30	28	33
GS32-125	230	24	30	30	28	33
GS32-160.1	230	24	30	30	28	33
GS32-160	230	24	30	30	28	33
GS32-200.1	230	24	30	30	28	33
GS32-200	230	24	30	30	28	33
GS32-250	230	24	30	30	28	33
GS40-125	230	24	30	30	28	33
GS40-160	230	24	30	30	28	33
GS40-200	230	24	30	30	28	33
GS40-250	230	24	30	30	28	33
GS40-315	240	32	40	40	38	43
GS50-125	230	24	30	30	28	33
GS50-160	230	24	30	30	28	33
GS50-200	230	24	30	30	28	33
GS50-250	230	24	30	30	28	33
GS50-315	240	32	40	40	38	43
GS65-125	230	24	30	30	28	33
GS65-160	230	24	30	30	28	33
GS65-200	230	24	30	30	28	33
GS65-250	240	32	40	40	38	43
GS65-315	240	32	40	40	38	43
GS80-160	230	24	30	30	28	33
GS80-200	240	32	40	40	38	43
GS80-250	240	32	40	40	38	43
GS80-315	240	32	40	40	38	43
GS80-315L	250	42	50	50	48	53
GS80-400	250	42	50	50	48	53
GS100-160	240	32	40	40	38	43
GS100-200	240	32	40	40	38	43
GS100-250	240	32	40	40	38	43
GS100-250L	250	42	50	50	48	53
GS100-315	240	32	40	40	38	43
GS100-315L	250	42	50	50	48	53
GS100-400	250	42	50	50	48	53
GS125-200	240	32	40	40	38	43
GS125-250	240	32	40	40	38	43
GS125-250L	250	42	50	50	48	53
GS125-315	250	42	50	50	48	53
GS125-400	250	42	50	50	48	53
GS125-500	260	48	60	60	55	60
GS150-200	240	32	40	40	38	43
GS150-250	250	42	50	50	48	53
GS150-315	250	42	50	50	48	53
GS150-400	250	42	50	50	48	53
GS150-400L	260	48	60	60	55	60
GS150-500	270	60	70	70	65	70
GS200-400	270	60	70	70	65	70
GS200-500	280	75	80	80	75	80

1. Maximum Allowable Working Pressure (MAWP)

Pressure casing material	Liquid temperature	Max. allowable working pressures	Flange standard
Cast iron	-10°C to 140°C	16 bar (1.6MPa)	EN PN16
		14bar (1.4MPa)	JIS 10K
Ductile cast iron	-10°C to 140°C	25 bar (2.5MPa)	EN PN25
			JIS 20K

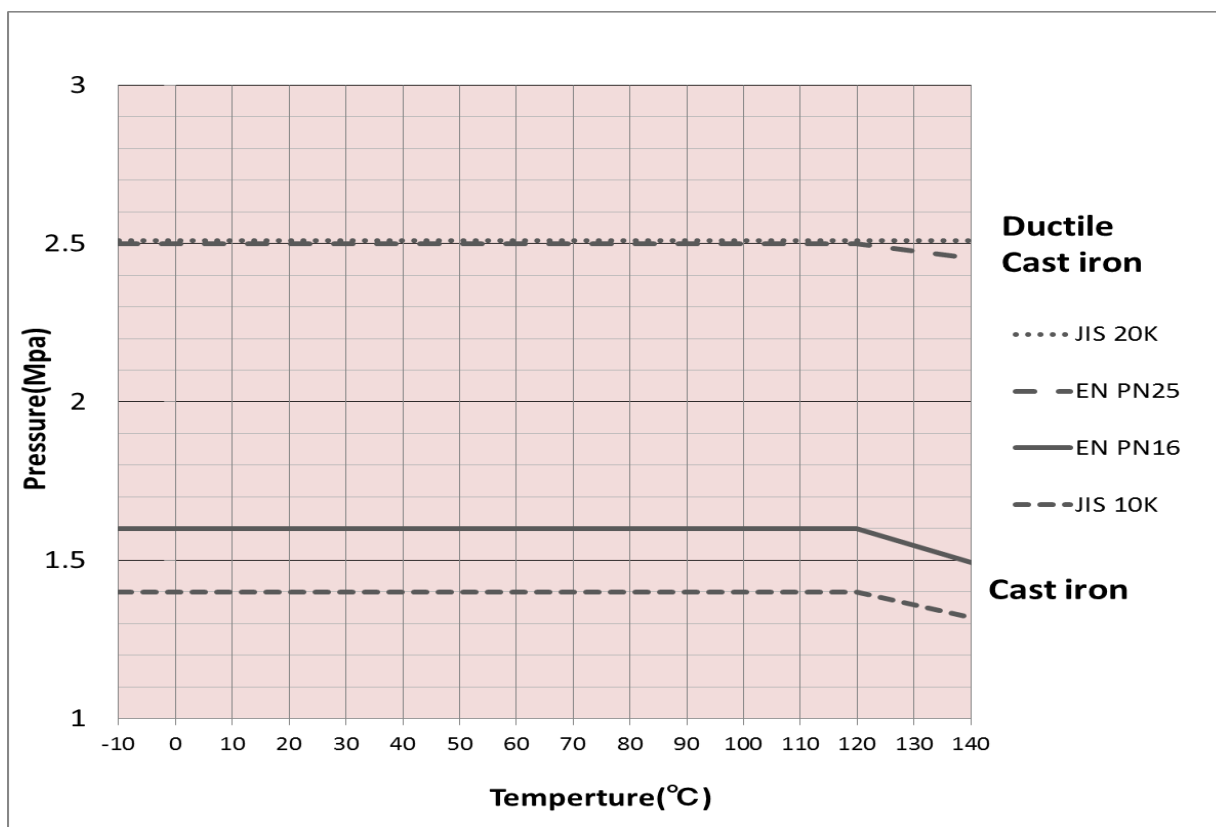

2. Maximum Allowable Suction Pressure (MASP)

(1) Mechanical Seal Application

Maximum Allowable Suction Pressure (MASP) must be smaller than the difference between the Maximum Allowable Working Pressure (MAWP) and Pump Shut-off Pressure (PSP), as follows. However, MASP shall not exceed 16 bar.

$$MASP < MAWP - PSP$$

$$[ \text{PSP(in bar)} = 0.098 \times \text{Pump Shut-off Head(in m)} \times \text{Liquid Density(in kg/}\ell\text{)} ]$$

(2) Gland Packing Application

Maximum Allowable Suction Pressure (MASP) of Gland Packing application is **6 bar** as standard.

TECHNICAL DATA - Interchangeability Chart

Interchangeability Chart										For Gland packing	
Model	Shaft No.	Impeller (*1)	Ball Bearing	Deflector	Case Wear Ring (front side)	Case Wear Ring (back side)	O Ring (for casing)	Mechanical Seal	Shaft Sleeve	Sleeve Gasket	Gland Packing
GS32-125.1	230	Depends on each model	A	A	A	A	A	A	A	A	A
GS32-125	230		A	A	A	A	A	A	A	A	A
GS32-160.1	230		A	A	A	A	A	A	A	A	A
GS32-160	230		A	A	A	A	A	A	A	A	A
GS32-200.1	230		A	A	A	A	B	B	A	A	A
GS32-200	230		A	A	A	A	A	A	A	A	A
GS32-250	230		A	A	A	A	A	C	A	A	A
GS40-125	230		A	A	A	B	B	A	A	A	A
GS40-160	230		A	A	A	B	B	A	A	A	A
GS40-200	230		A	A	A	B	B	A	A	A	A
GS40-250	230		A	A	A	B	B	C	A	A	A
GS40-315	240		A	B	B	C	C	D	B	B	B
GS50-125	230		A	A	A	C	C	A	A	A	A
GS50-160	230		A	A	A	C	C	A	A	A	A
GS50-200	230		A	A	A	C	C	B	A	A	A
GS50-250	230		A	A	A	C	C	C	A	A	A
GS50-315	240		A	B	B	D	D	D	B	B	B
GS65-125	230		A	A	A	D	D	A	A	A	A
GS65-160	230		A	A	A	D	D	A	A	A	A
GS65-200	230		A	A	A	D	D	B	A	A	A
GS65-250	240		A	B	B	D	D	C	B	B	B
GS65-315	240		A	B	B	E	E	D	B	B	B
GS80-160	230		A	A	A	E	E	A	A	A	A
GS80-200	240		A	B	B	E	E	B	B	B	B
GS80-250	240		A	B	B	F	F	C	B	B	B
GS80-315	240		A	B	B	F	F	D	B	B	B
GS80-315L	250		A	C	C	F	F	D	C	C	C
GS80-400	250		A	C	C	F	F	E	C	C	C
GS100-160	240	A	B	B	F	F	A	B	B	B	
GS100-200	240	A	B	B	G	G	H	B	B	B	
GS100-250	240	A	B	B	G	G	H	C	B	B	
GS100-250L	250	A	C	C	G	G	H	C	C	C	
GS100-315	240	A	B	B	G	G	I	D	B	B	
GS100-315L	250	A	C	C	G	G	I	D	C	C	
GS100-400	250	A	C	C	H	H	J	E	C	C	
GS125-200	240	A	B	B	H	H	B	B	B	B	
GS125-250	240	A	B	B	I	I	C	B	B	B	
GS125-250L	250	A	C	C	I	I	K	C	C	C	
GS125-315	250	A	C	C	J	J	K	D	C	C	
GS125-400	250	A	C	C	J	J	L	E	C	C	
GS125-500	260	A	D	D	K	K	M	F	D	D	
GS150-200	240	A	B	B	I	I	B	B	B	B	
GS150-250	250	A	C	C	L	L	N	C	C	C	
GS150-315	250	A	C	C	L	L	N	D	C	C	
GS150-400	250	A	C	C	M	M	O	E	C	C	
GS150-400L	260	A	D	D	M	M	O	E	D	D	
GS150-500	270	A	E	E	N	N	P	F	E	E	
GS200-400	270	A	E	E	O	O	Q	E	E	E	
GS200-500	280	A	F	F	O	O	Q	F	F	F	

Note: Materials of every parts should be specified by the section of "Materials of Construction".

The same letters in the same vertical column are interchangeable.

\*1: FC and FCD impellers are coated with cationic electro-deposition painting.

Nominal dimension of parts

Model	Shaft No.	Case Wear Ring (front side)	Case Wear Ring (back side)	O Ring (for casing)	Ball Bearing	For Gland Paking	
						Gland Packing	Sleeve Gasket
GS32-125.1	230	76	76	3.53X183.74	6306ZZ	33X49X8	24X28X1
GS32-125	230	76	76	3.53X183.74	6306ZZ	33X49X8	24X28X1
GS32-160.1	230	76	76	3.53X183.74	6306ZZ	33X49X8	24X28X1
GS32-160	230	76	76	3.53X183.74	6306ZZ	33X49X8	24X28X1
GS32-200.1	230	76	76	3.53X234.54	6306ZZ	33X49X8	24X28X1
GS32-200	230	76	76	3.53X234.54	6306ZZ	33X49X8	24X28X1
GS32-250	230	76	76	3.53X278.99	6306ZZ	33X49X8	24X28X1
GS40-125	230	88	88	3.53X183.74	6306ZZ	33X49X8	24X28X1
GS40-160	230	88	88	3.53X183.74	6306ZZ	33X49X8	24X28X1
GS40-200	230	88	88	3.53X234.54	6306ZZ	33X49X8	24X28X1
GS40-250	230	88	88	3.53X278.99	6306ZZ	33X49X8	24X28X1
GS40-315	240	100	100	3.53X355.19	6308ZZ	43X63X10	32X38X1
GS50-125	230	100	100	3.53X183.74	6306ZZ	33X49X8	24X28X1
GS50-160	230	100	100	3.53X183.74	6306ZZ	33X49X8	24X28X1
GS50-200	230	100	100	3.53X234.54	6306ZZ	33X49X8	24X28X1
GS50-250	230	100	100	3.53X278.99	6306ZZ	33X49X8	24X28X1
GS50-315	240	116	116	3.53X355.19	6308ZZ	43X63X10	32X38X1
GS65-125	230	116	116	3.53X183.74	6306ZZ	33X49X8	24X28X1
GS65-160	230	116	116	3.53X183.74	6306ZZ	33X49X8	24X28X1
GS65-200	230	116	116	3.53X234.54	6306ZZ	33X49X8	24X28X1
GS65-250	240	116	116	3.53X278.99	6308ZZ	43X63X10	32X38X1
GS65-315	240	132	132	3.53X355.19	6308ZZ	43X63X10	32X38X1
GS80-160	230	132	132	3.53X183.74	6306ZZ	33X49X8	24X28X1
GS80-200	240	132	132	3.53X234.54	6308ZZ	43X63X10	32X38X1
GS80-250	240	148	148	3.53X278.99	6308ZZ	43X63X10	32X38X1
GS80-315	240	148	148	3.53X355.19	6308ZZ	43X63X10	32X38X1
GS80-315L	250	148	148	3.53X355.19	6310ZZ	53X73X10	42X48X1
GS80-400	250	148	148	5.33X456.06	6310ZZ	53X73X10	42X48X1
GS100-160	240	148	153	3.53X183.74	6308ZZ	43X63X10	32X38X1
GS100-200	240	158	158	3.53X234.54	6308ZZ	43X63X10	32X38X1
GS100-250	240	158	158	3.53X278.99	6308ZZ	43X63X10	32X38X1
GS100-250L	250	158	158	3.53X278.99	6310ZZ	53X73X10	42X48X1
GS100-315	240	158	162	3.53X355.19	6308ZZ	43X63X10	32X38X1
GS100-315L	250	158	162	3.53X355.19	6310ZZ	53X73X10	42X48X1
GS100-400	250	168	168	5.33X456.06	6310ZZ	53X73X10	42X48X1
GS125-200	240	168	158	3.53X234.54	6308ZZ	43X63X10	32X38X1
GS125-250	240	178	168	3.53X278.99	6308ZZ	43X63X10	32X38X1
GS125-250L	250	178	178	3.53X278.99	6310ZZ	53X73X10	42X48X1
GS125-315	250	188	178	3.53X355.19	6310ZZ	53X73X10	42X48X1
GS125-400	250	188	188	5.33X456.06	6310ZZ	53X73X10	42X48X1
GS125-500	260	200	200	5.33X532.26	6312ZZ	60X85X12.5	48X55X1
GS150-200	240	178	162	3.53X234.54	6308ZZ	43X63X10	32X38X1
GS150-250	250	212	212	3.53X278.99	6310ZZ	53X73X10	42X48X1
GS150-315	250	212	212	3.53X355.19	6310ZZ	53X73X10	42X48X1
GS150-400	250	236	236	5.33X456.06	6310ZZ	53X73X10	42X48X1
GS150-400L	260	236	236	5.33X456.06	6312ZZ	60X85X12.5	48X55X1
GS150-500	270	250	250	5.33X532.26	6314ZZ	70X95X12.5	60X65X1
GS200-400	270	278	278	5.33X456.06	6314ZZ	70X95X12.5	60X65X1
GS200-500	280	278	278	5.33X532.26	6316ZZ	80X109X14.5	70X75X1

Note: Materials of every parts should be specified by the section of "Materials of Construction".

Figures in above chart show nominal parts size.

**TECHNICAL DATA – Noise Data**

Model	50Hz		60Hz	
	2900 mim <sup>-1</sup> (2 Pole)	1450 mim <sup>-1</sup> (4 Pole)	3500 mim <sup>-1</sup> (2 Pole)	1750 mim <sup>-1</sup> (4 Pole)
	Overall Sound Pressure Level dB(A)			
GS32-125.1	62	52	66	54
GS32-125	64	52	68	54
GS32-160.1	66	54	70	58
GS32-160	68	54	72	58
GS32-200.1	68	54	72	58
GS32-200	72	58	74	62
GS32-250	73	62	76	65
GS40-125	66	54	70	58
GS40-160	70	58	73	62
GS40-200	73	62	77	65
GS40-250	76	63	80	67
GS40-315	81	69	—	71
GS50-125	70	54	72	58
GS50-160	72	58	76	63
GS50-200	76	63	78	67
GS50-250	78	67	80	69
GS50-315	83	71	—	73
GS65-125	70	58	74	62
GS65-160	74	62	77	65
GS65-200	77	65	80	69
GS65-250	81	69	84	71
GS65-315	85	72	—	74
GS80-160	76	63	80	67
GS80-200	81	69	83	71
GS80-250	84	71	85	73
GS80-315	—	74	—	77
GS80-315L	87	—	—	—
GS80-400	—	78	—	80
GS100-160	77	65	80	67
GS100-200	81	69	85	72
GS100-250	85	72	—	74
GS100-250L	—	—	88	—
GS100-315	—	74	—	77
GS100-315L	87	—	—	—
GS100-400	—	78	—	80
GS125-200	84	71	85	73
GS125-250	—	74	—	77
GS125-250L	87	—	89	—
GS125-315	89	77	—	79
GS125-400	—	79	—	82
GS125-500	—	81	—	84
GS150-200	84	71	85	73
GS150-250	89	77	—	79
GS150-315	—	79	—	82
GS150-400	—	80	—	—
GS150-400L	—	—	—	84
GS150-500	—	84	—	86
GS200-400	—	85	—	88
GS200-500	—	88	—	91

Note : The overall sound pressure level is the value measured 1m away from the pump unit and does not include driver noise.

**DIMENSIONS - Dimensions of Bare Shaft Pump**

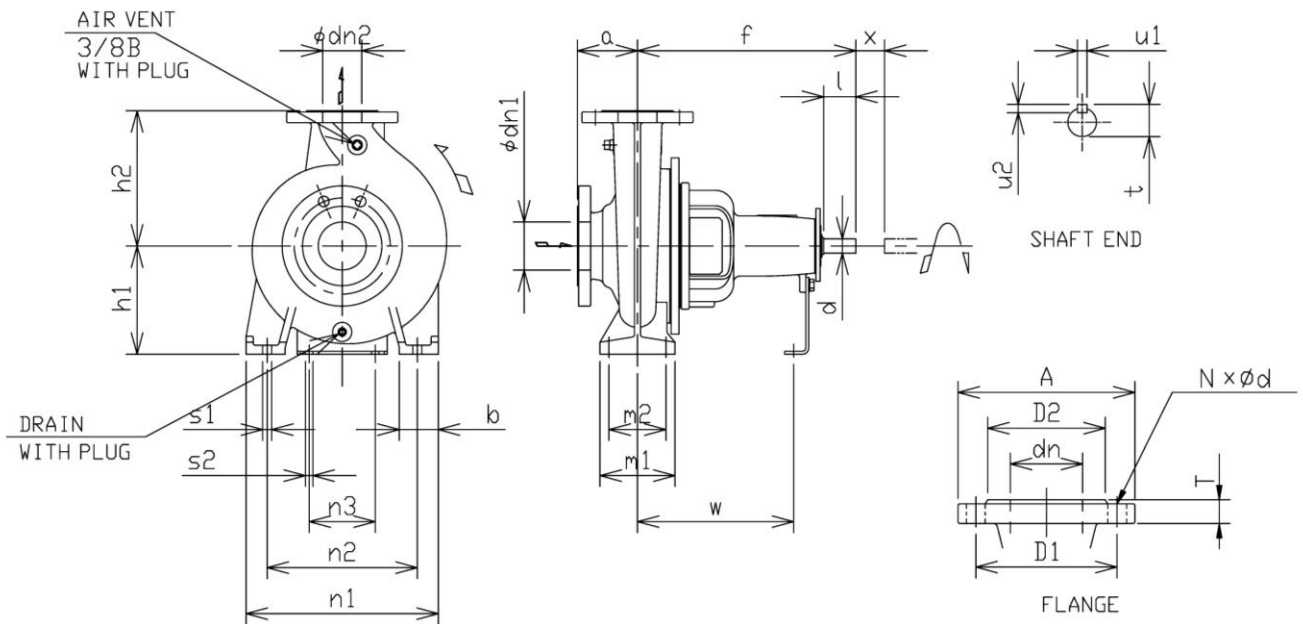

**Flange Dimension**

Material: **Cast Iron**  
Flange Standard: **EN PN16**

Unit: mm

Model	Suction flange							Discharge flange						
	dn1	A	D1	D2	T	N	d	dn2	A	D1	D2	T	N	d
GS32	50	165	125	99	20	4	19	32	140	100	76	18	4	19
GS40	65	185	145	118	20	4	19	40	150	110	84	18	4	19
GS50	65	185	145	118	20	4	19	50	165	125	99	20	4	19
GS65	80	200	160	132	22	8	19	65	185	145	118	20	4	19
GS80	100	220	180	156	24	8	19	80	200	160	132	22	8	19
GS100	125	250	210	184	26	8	19	100	220	180	156	24	8	19
GS125	150	285	240	211	26	8	23	125	250	210	184	26	8	19
GS150	200	340	295	266	30	12	23	150	285	240	211	26	8	23
GS200	250	405	355	319	32	12	28	200	340	295	266	30	12	23

Flange Standard: **JIS 10K**

Unit: mm

Model	Suction flange							Discharge flange						
	dn1	A	D1	D2	T	N	d	dn2	A	D1	D2	T	N	d
GS32	50	155	120	96	20	4	19	32	135	100	76	20	4	19
GS40	65	175	140	116	22	4	19	40	140	105	81	20	4	19
GS50	65	175	140	116	22	4	19	50	155	120	96	20	4	19
GS65	80	185	150	126	22	8	19	65	175	140	116	22	4	19
GS80	100	210	175	151	24	8	19	80	185	150	126	22	8	19
GS100	125	250	210	182	24	8	23	100	210	175	151	24	8	19
GS125	150	280	240	212	26	8	23	125	250	210	182	24	8	23
GS150	200	330	290	262	26	12	23	150	280	240	212	26	8	23
GS200	250	400	355	324	30	12	25	200	330	290	262	26	12	23

Material: **Ductile Cast Iron**  
Flange Standard: **EN PN25**

Unit: mm

Model	Suction flange							Discharge flange						
	dn1	A	D1	D2	T	N	d	dn2	A	D1	D2	T	N	d
GS80	100	235	190	156	19	8	23	80	200	160	132	19	8	19
GS100	125	270	220	184	19	8	28	100	235	190	156	19	8	23
GS125	150	300	250	211	20	8	28	125	270	220	184	19	8	28
GS150	200	360	310	274	22	12	28	150	300	250	211	20	8	28
GS200	250	425	370	330	24.5	12	31	200	360	310	274	22	12	28

Flange Standard: **JIS 20K**

Unit: mm

Model	Suction flange							Discharge flange						
	dn1	A	D1	D2	T	N	d	dn2	A	D1	D2	T	N	d
GS80	100	225	185	160	24	8	23	80	200	160	132	22	8	23
GS100	125	270	225	195	26	8	25	100	225	185	160	24	8	23
GS125	150	305	260	230	28	12	25	125	270	225	195	26	8	25
GS150	200	350	305	275	30	12	25	150	305	260	230	28	12	25
GS200	250	430	380	345	34	12	27	200	350	305	275	30	12	25





Steel Baseplate (Fig. A) Up to 90kW \*

\*Except for model GS/GSS 200-400

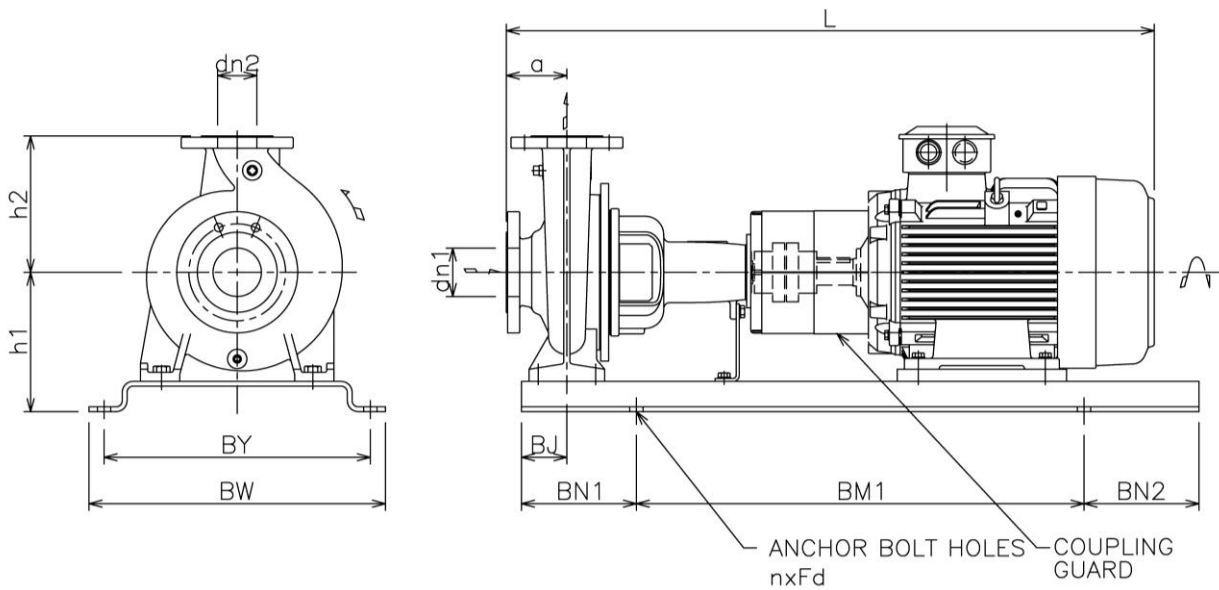

This baseplate is not necessary to grout .

Special base can be provided for grouting.

Fabricated Baseplate (Fig. B) 110kW and over

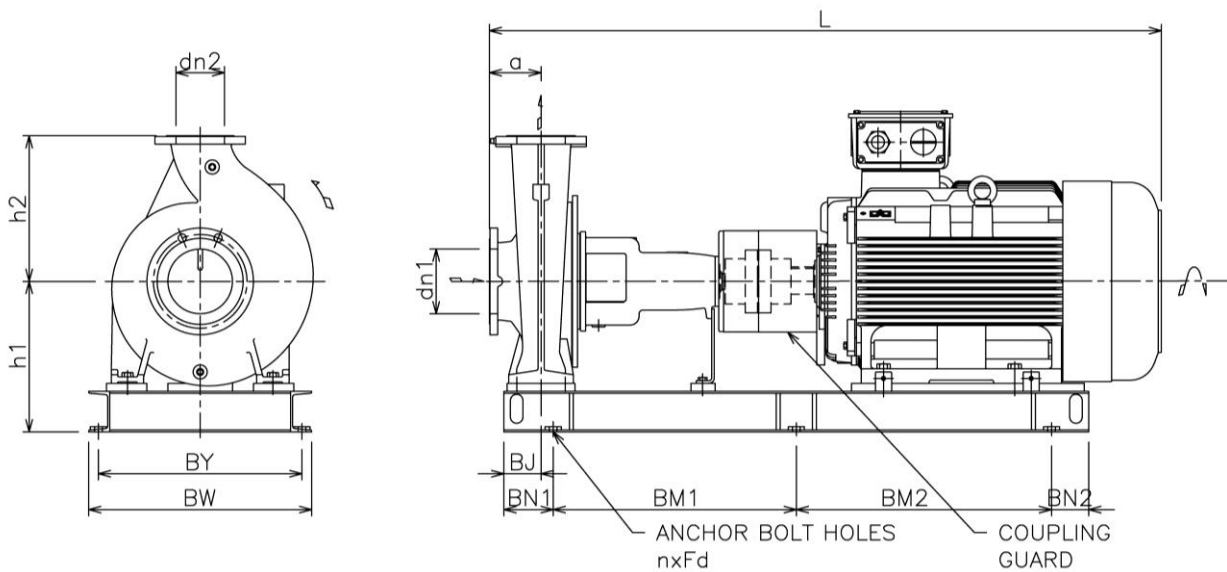

## DIMENSIONS - Dimensions of Pump with motor(2P)

GS PUMP-2P 50Hz/60Hz ✓ : Applicable Doc.No.6312-W69092\_rev0

Model	Pole	Hz		Power kW	Fig	Size		Pump		Mass (kg)	Motor ※1)		Baseplate										Total (Approx.)	
		50	60			φ 1	φ 2	a	h2		Frame	Mass (kg)	h1	BJ	BM1	BM2	BN1	BN2	BY	BW	nxFd	Mass (kg)	L	Mass (kg)
32-125.1	2	✓	✓	0.75	A	50	32	80	140	28	80M	16.5	162	60	540	-	130	130	320	360	4xM16	21	736	76
		✓	✓	1.1							80M	18											78	78
		✓	✓	1.5							90S	23											82	82
		✓	✓	2.2							90L	27											87	87
		✓	✓	3							100L	37.5											98	98
		✓	✓	4							112M	47.5											110	110
		✓	✓	5.5							132S	61											132	132
32-125	2	✓	✓	0.75	A	50	32	80	140	28	80M	16.5	162	60	540	-	130	130	320	360	4xM16	21	736	76
		✓	✓	1.1							80M	18											78	78
		✓	✓	1.5							90S	23											82	82
		✓	✓	2.2							90L	27											87	87
		✓	✓	3							100L	37.5											98	98
		✓	✓	4							112M	47.5											110	110
		✓	✓	5.5							132S	61											132	132
32-160.1	2	✓	✓	1.5	A	50	32	80	160	29	90S	23	182	60	540	-	130	130	350	390	4xM16	23	787	88
		✓	✓	2.2							90L	27											92	92
		✓	✓	3							100L	37.5											105	105
		✓	✓	4							112M	47.5											114	114
		✓	✓	5.5							132S	61											131	131
		✓	✓	7.5							132S	65											136	136
		✓	✓	11							160M	105											189	189
32-160	2	✓	✓	2.2	A	50	32	80	160	29	90L	27	182	60	540	-	130	130	350	390	4xM16	23	812	92
		✓	✓	3							100L	37.5											105	105
		✓	✓	4							112M	47.5											114	114
		✓	✓	5.5							132S	61											131	131
		✓	✓	7.5							132S	65											136	136
		✓	✓	11							160M	105											189	189
		✓	✓	15							160M	120											206	206
32-200.1	2	✓	✓	3	A	50	32	80	180	39	100L	37.5	210	60	540	-	130	130	350	390	4xM16	23	835	117
		✓	✓	4							112M	47.5											129	129
		✓	✓	5.5							132S	61											145	145
		✓	✓	7.5							132S	65											150	150
		✓	✓	11							160M	105											199	199
		✓	✓	15							160M	120											215	215
		✓	✓	15							160M	120											215	215
32-200	2	✓	✓	5.5	A	50	32	80	180	39	132S	61	210	60	600	-	150	150	350	390	4xM16	25	909	145
		✓	✓	7.5							132S	65											150	150
		✓	✓	11							160M	105											199	199
		✓	✓	15							160M	120											215	215
		✓	✓	18.5							160L	135											232	232
		✓	✓	22							180M	175											282	282
		✓	✓	22							180M	175											282	282
32-250	2	✓	✓	7.5	A	50	32	100	225	46	132S	65	230	75	660	-	150	150	440	490	4xM20	31	929	169
		✓	✓	11							160M	105											215	215
		✓	✓	15							160M	120											232	232
		✓	✓	18.5							160L	135											248	248
		✓	✓	22							180M	175											288	288
		✓	✓	30							200L	240											370	370
		✓	✓	30							200L	240											370	370
40-125	2	✓	✓	1.5	A	65	40	80	140	30	90S	23	162	60	540	-	130	130	320	360	4xM16	21	787	84
		✓	✓	2.2							90L	27											89	89
		✓	✓	3							100L	37.5											100	100
		✓	✓	4							112M	47.5											112	112
		✓	✓	5.5							132S	61											134	134
		✓	✓	7.5							132S	65											138	138
		✓	✓	11							160M	105											192	192
40-160	2	✓	✓	4	A	65	40	80	160	31	112M	47.5	182	60	600	-	150	150	350	390	4xM16	23	855	116
		✓	✓	5.5							132S	61											134	134
		✓	✓	7.5							132S	65											138	138
		✓	✓	11							160M	105											192	192
		✓	✓	15							160M	120											208	208
		✓	✓	18.5							160L	135											225	225
		✓	✓	18.5							160L	135											225	225
40-200	2	✓	✓	7.5	A	65	40	100	180	41	132S	65	210	60	660	-	150	150	350	390	4xM16	25	929	152
		✓	✓	11							160M	105											201	201
		✓	✓	15							160M	120											217	217
		✓	✓	18.5							160L	135											234	234
		✓	✓	22							180M	175											284	284
		✓	✓	30							200L	240											369	369
		✓	✓	37							200L	270											402	402
40-250	2	✓	✓	11	A	65	40	100	225	48	160M	105	230	75	740	-	190	190	490	540	4xM20	35	1071	217
		✓	✓	15							160M	120											233	233
		✓	✓	18.5							160L	135											250	250
		✓	✓	22							180M	175											291	291
		✓	✓	30							200L	240											376	376
		✓	✓	37							200L	270											409	409
		✓	✓	45							225MA	315											488	488
40-315	2	✓	✓	22	A	65	40	125	250	82	250MA	405	275	75	940	-	205	205	550	610	4xM24	66	1275	355
		✓	✓	30							200L	240											425	425
		✓	✓	37							200L	270											458	458
		✓	✓	45							225MA	315											520	520
		✓	✓	55							250MA	405											641	641
		✓	✓	55							250MA	405											641	641
		✓	✓	75							280SA	515											802	802

※1) Up to 55kW: EBARA motor  
more than 75kW: TECO motor(AESV)

## DIMENSIONS - Dimensions of Pump with motor(2P)

GS PUMP-2P 50Hz/60Hz ✓ : Applicable Doc.No.6312-W69092\_rev0

Model	Pole	Hz		Power kW	Fig	Size				Pump Mass (kg)	Motor ※1		Baseplate										Total (Approx.)		
		50	60			φ 1	φ 2	a	h2		Frame	Mass (kg)	h1	BJ	BM1	BM2	BN1	BN2	BY	BW	nxFd	Mass (kg)	L	Mass (kg)	
50-125	2	✓	✓	2.2	A	65	50	100	160	33	90L	27	182	60	600	-	130	130	350	390	4xM16	23	832	97	
		100L	37.5	855							110														
		112M	47.5	875							118														
		132S	61	929							136														
		132S	65	940							140														
		160M	105	1071							194														
50-160	2	✓	✓	5.5	A	65	50	100	180	33	132S	61	210	660	-	170	170	400	450	4xM16	25	929	139		
		132S	65	940							143														
		160M	105	1071							192														
		160M	120	1115							225														
		160L	135	1136							275														
		180M	175	1234							360														
50-200	2	✓	✓	11	A	65	50	100	200	44	160M	105	210	740	-	190	190	490	540	4xM20	32	1071	204		
		160M	120	1115							237														
		160L	135	1136							287														
		180M	175	1234							372														
		200L	270	1369							405														
		225MA	315	1410							482														
50-250	2	✓	✓	22	A	65	50	100	225	50	180M	175	230	840	-	205	205	550	610	4xM24	35	1136	293		
		200L	240	1234							378														
		200L	270	1275							411														
		225MA	315	1385							490														
		250MA	405	1495							611														
		280SA	515	1636							797														
50-315	2	✓	✓	30	A	65	50	125	280	86	200L	240	275	940	-	230	230	600	660	4xM20	47	1369	430		
		200L	270	1410							524														
		225MA	315	1520							645														
		250MA	405	1636							797														
		280SA	515	1797							847														
		280MA	552	1868							847														
65-125	2	✓	✓	4	A	80	65	100	180	37	112M	47.5	210	75	660	-	170	170	400	450	4xM20	32	875	130	
		132S	61	929							151														
		132S	65	940							155														
		160M	105	1071							196														
		160M	120	1115							213														
		160L	135	1136							229														
65-160	2	✓	✓	7.5	A	80	65	100	200	41	132S	65	210	75	660	-	170	170	400	450	4xM20	32	929	160	
		160M	105	1071							201														
		160M	120	1115							217														
		160L	135	1136							234														
		180M	175	1234							285														
		200L	240	1369							370														
65-200	2	✓	✓	11	A	80	65	100	225	47	160M	105	230	740	-	190	190	490	540	4xM20	35	1071	216		
		160M	120	1115							232														
		160L	135	1136							249														
		180M	175	1234							289														
		200L	240	1369							375														
		225MA	315	1410							408														
65-250	2	✓	✓	22	A	80	65	100	250	73	180M	175	250	840	-	205	205	550	610	4xM24	47	1246	337		
		200L	240	1369							407														
		200L	270	1410							440														
		225MA	315	1495							514														
		250MA	405	1636							637														
		280SA	515	1797							791														
65-315	2	✓	✓	30	A	80	65	125	280	90	280MA	552	380	1060	-	270	270	670	730	4xM24	104	1611	832		
		315SA	800	1868							855														
		250MA	405	1520							651														
		280SA	515	1636							805														
		280MA	552	1686							855														
		315SA	800	1815							1173														
80-160	2	✓	✓	11	A	100	80	125	225	46	160M	105	230	75	660	-	170	170	440	490	4xM20	35	1096	215	
		160M	120	1140							231														
		160L	135	1161							248														
		180M	175	1234							288														
		200L	240	1369							374														
		200L	270	1410							407														
80-200	2	✓	✓	18.5	A	100	80	125	250	67	225MA	315	300	840	-	205	205	550	610	4xM24	66	1300	485		
		250MA	405	1410							606														
		280SA	515	1636							781														
		280MA	552	1686							822														
		315SA	800	1815							1164														
		315MA	900	1865							1274														
80-250	2	✓	✓	22	A	100	80	125	280	77	180M	175	230	90	660	-	205	205	550	610	4xM24	66	1410	519	
		200L	240	1495							641														
		200L	270	1520							641														
		225MA	315	1636							795														
		250MA	405	1797							959														
		280SA	515	1960							1124														
80-315L	2	✓	✓	30	B	100	80	125	315	112	280MA	552	380	1060	-	270	270	670	730	4xM24	104	1746	875		
		315SA	800	1875							1203														
		315LA	980	1925							1313														
		315LA	980	1925							1313														
		315LA	980	1925							1313														
		315LA	1100	2025							1546														

※1) Up to 55kW: EBARA motor  
more than 75kW: TECO motor(AESV)

DIMENSIONS - Dimensions of Pump with motor(2P)

GS PUMP-2P 50Hz/60Hz

✓ : Applicable

Doc.No.6312-W69092\_rev0

Table with columns: Model, Pole, Hz, Power, Size, Pump, Motor, Baseplate, and Total (Approx.). Rows include models 100-160, 100-200, 100-250, 100-250L, 100-315L, 125-200, 125-250L, 125-315, 150-200, and 150-250.

※1) Up to 55kW: EBARA motor more than 75kW: TECO motor(AESV)



**DIMENSIONS - Dimensions of Pump with motor(4P)**

GS PUMP-4P 50Hz/60Hz ✓ : Applicable Doc.No.6312-W69093\_rev0

Model	Pole	Hz		Power kW	Fig	Size				Pump		Motor ※1		Baseplate										Total (Approx.)	
		50	60			φ 1	φ 2	a	h2	Mass (kg)	Frame	Mass (kg)	h1	BJ	BM1	BM2	BN1	BN2	BY	BW	nxFd	Mass (kg)	L	Mass (kg)	
32-125.1	4	✓	✓	0.55	A	50	32	80	140	28	80M	15	162	60	540	-	130	130	320	360	4xM16	21	736	75	
		80M	16.5	76																					
32-125	4	✓	✓	0.55	A	50	32	80	140	28	80M	15	162	60	540	-	130	130	320	360	4xM16	21	736	75	
		80M	16.5	76																					
		90S	22	81																					
32-160.1	4	✓	✓	0.55	A	50	32	80	160	29	80M	15	182	60	540	-	130	130	350	390	4xM16	23	736	79	
		80M	16.5	80																					
		90S	22	87																					
		90L	24	89																					
32-160	4	✓	✓	0.55	A	50	32	80	160	29	80M	15	182	60	540	-	130	130	350	390	4xM16	23	736	79	
		80M	16.5	80																					
		90S	22	87																					
		90L	24	89																					
32-200.1	4	✓	✓	0.55	A	50	32	80	180	39	80M	15	210	60	540	-	130	130	350	390	4xM16	23	736	90	
		80M	16.5	92																					
		90S	22	99																					
		90L	24	101																					
		100L	32	111																					
32-200	4	✓	✓	0.75	A	50	32	80	180	39	80M	16.5	210	60	540	-	130	130	350	390	4xM16	23	736	92	
		90S	22	99																					
		90L	24	101																					
		100L	32	111																					
		100L	37.5	118																					
		100L	37.5	118																					
32-250	4	✓	✓	0.75	A	50	32	100	225	46	80M	16.5	230	75	600	-	150	150	440	490	4xM20	31	736	109	
		90S	22	116																					
		90L	24	118																					
		100L	32	129																					
		100L	37.5	136																					
		112M	47.5	147																					
40-125	4	✓	✓	0.55	A	65	40	80	140	30	80M	15	162	60	540	-	130	130	320	360	4xM16	21	736	77	
		80M	16.5	79																					
		90S	22	83																					
		90L	24	86																					
		90L	24	86																					
40-160	4	✓	✓	0.55	A	65	40	80	160	31	80M	15	182	60	540	-	130	130	350	390	4xM16	23	736	81	
		80M	16.5	83																					
		90S	22	89																					
		90L	24	91																					
		100L	32	101																					
		100L	37.5	108																					
40-200	4	✓	✓	1.1	A	65	40	100	180	41	90S	22	210	60	540	-	130	130	350	390	4xM16	23	736	101	
		90L	24	103																					
		100L	32	113																					
		100L	37.5	120																					
		112M	47.5	132																					
		132S	64	151																					
40-250	4	✓	✓	1.5	A	65	40	100	225	48	90L	24	230	75	600	-	150	150	440	490	4xM20	31	736	120	
		100L	32	131																					
		100L	37.5	138																					
		112M	47.5	149																					
		132S	64	170																					
		132M	78	186																					
40-315	4	✓	✓	2.2	A	65	40	125	250	82	100L	32	275	75	600	-	170	170	440	490	4xM20	31	736	171	
		100L	37.5	177																					
		112M	47.5	195																					
		132S	64	215																					
		132M	78	230																					
		160M	105	269																					
40-315	4	✓	✓	3	A	65	40	125	250	82	160L	130	275	75	740	-	190	190	440	490	4xM20	39	736	296	
		160L	130	296																					

※1) Up to 55kW: EBARA motor  
more than 75kW: TECO motor(AESV)

## DIMENSIONS - Dimensions of Pump with motor(4P)

GS PUMP-4P 50Hz/60Hz      ✓ : Applicable      Doc.No.6312-W69093\_rev0

Model	Pole	Hz		Power kW	Fig	Size			Pump		Motor ※1		Baseplate										Total (Approx.)	
		50	60			φ 1	φ 2	a	h2	Mass (kg)	Frame	Mass (kg)	h1	BJ	BM1	BM2	BN1	BN2	BY	BW	nxFd	Mass (kg)	L	Mass (kg)
50-125	4	✓	✓	0.55	A	65	50	100	160	33	80M	15	182	60	540	-	130	130	350	390	4xM16	23	756	83
		80M	16.5	807							91													
		90S	22	832							94													
		90L	24	855							103													
		100L	32																					
		100L	37.5																					
50-160	4	✓	✓	0.55	A	65	50	100	180	33	80M	15	210	60	540	-	130	130	350	390	4xM16	23	756	84
		80M	16.5	807							92													
		90S	22	832							94													
		90L	24	855							105													
		100L	32																					
		100L	37.5																					
50-200	4	✓	✓	1.1	A	65	50	100	200	44	90S	22	210	60	540	-	130	130	350	390	4xM16	23	807	104
		90L	24	832							106													
		100L	32	855							117													
		100L	37.5	876							124													
		112M	47.5	876							135													
		132S	64	929							154													
50-250	4	✓	✓	1.5	A	65	50	100	225	50	100L	32	230	75	600	-	150	150	440	490	4xM20	25	855	133
		100L	37.5	876							140													
		112M	47.5	876							151													
		132S	64	929							172													
		132M	78	967							188													
		160M	105	1071							219													
50-315	4	✓	✓	4	A	65	50	125	280	86	112M	47.5	275	75	660	-	170	170	440	490	4xM20	35	1011	198
		132S	64	1064							219													
		132M	78	1102							234													
		160M	105	1207							273													
		160L	130	1251							300													
		180M	175	1271							359													
65-125	4	✓	✓	0.55	A	80	65	100	180	37	80M	15	210	75	540	-	130	130	400	450	4xM20	26	756	92
		80M	16.5	807							93													
		90S	22	807							100													
		90L	24	832							102													
		100L	32	855							112													
		100L	37.5	855							119													
65-160	4	✓	✓	0.75	A	80	65	100	200	41	80M	16.5	210	75	540	-	130	130	400	450	4xM20	26	756	98
		90S	22	807							104													
		90L	24	832							106													
		100L	32	855							117													
		100L	37.5	855							124													
		112M	47.5	876							135													
65-200	4	✓	✓	1.1	A	80	65	100	225	47	90L	24	230	75	600	-	150	150	440	490	4xM20	31	832	119
		100L	32	855							130													
		100L	37.5	855							137													
		112M	47.5	876							148													
		132S	64	929							169													
		132M	78	967							184													
65-250	4	✓	✓	1.5	A	80	65	100	250	73	90L	24	250	90	740	-	190	190	490	540	4xM20	42	832	119
		100L	32	855							130													
		100L	37.5	855							137													
		112M	47.5	876							148													
		132S	64	929							169													
		132M	78	967							184													
65-315	4	✓	✓	3	A	80	65	100	250	73	100L	37.5	250	90	740	-	190	190	490	540	4xM20	42	965	178
		112M	47.5	986							190													
		132S	64	1039							211													
		132M	78	1077							226													
		160M	105	1181							264													
		160L	130	1226							293													

※1) Up to 55kW: EBARA motor  
more than 75kW: TECO motor(AESV)

## DIMENSIONS - Dimensions of Pump with motor(4P)

GS PUMP-4P 50Hz/60Hz ✓ : Applicable Doc.No.6312-W69093\_rev0

Model	Pole	Hz		Power kW	Fig	Size		Pump		Motor ※1		Baseplate								Total (Approx.)																				
		50	60			φ 1	φ 2	a	h2	Mass (kg)	Frame	Mass (kg)	h1	BJ	BM1	BM2	BN1	BN2	BY	BW	nxM	Fd	Mass (kg)	L	Mass (kg)															
80-160	4	✓		1.1	A	100	80	125	225	46	90S	22	230	75	600	-	150	150	440	490	4xM20	31	832	116																
		✓		1.5							90L	24											857	118																
		✓	✓	2.2							100L	32											880	129																
		✓	✓	3							100L	37.5											901	147																
		✓		4							112M	47.5											954	168																
		✓	✓	5.5							132S	64											992	183																
		✓	✓	7.5							132M	78																												
80-200	4	✓		2.2	A	100	80	125	250	67	100L	32	230	75	660	-	170	170	440	490	4xM20	31	990	153																
		✓		3							100L	37.5											1011	175																
		✓	✓	4							112M	47.5											1064	196																
		✓	✓	5.5							132S	64											1102	211																
		✓	✓	7.5							132M	78											1206	242																
		✓		11							160M	105											1251	271																
		✓	✓	15							160L	130											1251	271																
80-250	4	✓		5.5	A	100	80	125	280	77	132S	64	275	90	840	-	205	205	550	610	4xM24	66	1064	241																
		✓	✓	7.5							132M	78											1102	257																
		✓	✓	11							160M	105											1207	291																
		✓	✓	15							160L	130											1251	319																
		✓		18.5							180M	175											1271	362																
		✓	✓	22							180L	190											1309	382																
		✓																																						
80-315	4	✓		11	A	100	80	125	315	101	160M	105	325	90	840	-	205	205	550	610	4xM24	66	1207	321																
		✓		15							160L	130											1251	349																
		✓	✓	18.5							180M	175											1271	402																
		✓	✓	22							180L	190											1309	418																
		✓	✓	30							200L	255											1369	493																
		✓		37							225SC	315											1415	555																
		✓	✓	45							225MC	330											1440	572																
80-400	4	✓		11	A	100	80	125	355	162	160M	105	355	90	940	-	230	230	550	610	4xM24	66	1267	390																
		✓		15							160L	130											1311	418																
		✓	✓	18.5							180M	175											1331	480																
		✓	✓	22							180L	190											1369	497																
		✓	✓	30							200L	255											1429	578																
		✓	✓	37							225SC	315											1475	643																
		✓	✓	45							225MC	330											1500	668																
		✓		55							250MC	450											1580	798																
		✓	✓	75							280SB	566											1696	940																
		✓	✓	90							280MB	624											1746	1012																
		✓																																						
100-160	4	✓		2.2	A	125	100	125	250	91	100L	32	250	90	740	-	190	190	490	540	4xM20	42	990	192																
		✓		3							100L	37.5											1011	210																
		✓	✓	4							112M	47.5											1064	230																
		✓	✓	5.5							132S	64											1102	246																
		✓		7.5							132M	78																												
		✓																																						
		✓																																						
100-200	4	✓		4	A	125	100	125	280	103	112M	47.5	250	90	740	-	190	190	490	540	4xM20	42	1011	223																
		✓	✓	5.5							132S	64											1064	243																
		✓	✓	7.5							132M	78											1102	259																
		✓	✓	11							160M	105											1207	299																
		✓		15							160L	130											1251	326																
		✓	✓	18.5							180M	175											1271	370																
		✓																																						
100-250	4	✓		5.5	A	125	100	140	280	108	132S	64	300	90	840	-	205	205	550	610	4xM24	66	1079	277																
		✓		7.5							132M	78											1117	293																
		✓	✓	11							160M	105											1222	327																
		✓	✓	15							160L	130											1266	354																
		✓	✓	18.5							180M	175											1286	408																
		✓	✓	22							180L	190											1324	424																
		✓		30							200L	255											1384	491																
100-315	4	✓		7.5	A	125	100	140	315	109	132M	78	325	90	840	-	205	205	550	610	4xM24	66	1117	295																
		✓		11							160M	105											1222	330																
		✓	✓	15							160L	130											1266	358																
		✓	✓	18.5							180M	175											1286	410																
		✓	✓	22							180L	190											1324	427																
		✓	✓	30							200L	255											1384	507																
		✓		37							225SC	315											1430	564																
✓	✓	45	225MC	330	1455	580																																		
100-400	4	✓		15	A	125	100	140	355	189	160L	130	380	110	940	-	230	230	670	730	4xM24	92	1326	476																
		✓		18.5							180M	175											1346	530																
		✓	✓	22							180L	190											1384	546																
		✓	✓	30							200L	255											1444	627																
		✓	✓	37							225SC	315											1490	692																
		✓	✓	45							225MC	330											1515	718																
		✓		55							250MC	450											1595	842																
		✓	✓	75							280SB	566											1711	969																
		✓	✓	90							280MB	624											1761	1042																
		✓																																						

※1) Up to 55kW: EBARA motor  
more than 75kW: TECO motor(AESV)



## DIMENSIONS - Dimensions of Pump with motor(4P)

GS PUMP-4P 50Hz/60Hz				✓ : Applicable		Doc.No.6312-W69093_rev0																								
Model	Pole	Hz		Power kW	Fig	Size		Pump		Motor ※1		Baseplate								Total (Approx.)										
		50	60			φ 1	φ 2	a	h2	Mass (kg)	Frame	Mass (kg)	h1	BJ	BM1	BM2	BN1	BN2	BY	BW	nxFd	Mass (kg)	L	Mass (kg)						
125-200	4	✓		5.5	A	150	125	140	315	120	132S	64	325	90	840	-	205	205	550	610	4xM24	66	1079	291						
		✓	✓	7.5							132M	78											1117	307						
		✓	✓	11							160M	105											1222	342						
		✓	✓	15							160L	130											1266	370						
			✓	18.5							180M	175											1286	419						
			✓	22							180L	190											1324	439						
125-250	4	✓		11	A	150	125	140	355	131	160M	105	325	90	840	-	205	205	550	610	4xM24	66	1222	354						
		✓		15							160L	130											1266	382						
		✓	✓	18.5							180M	175											1286	435						
		✓	✓	22							180L	190											1324	451						
			✓	30							200L	255											1384	531						
			✓	37							225SC	315											1430	588						
			✓	45							225MC	330											1455	605						
			✓	55							250MC	450											1595	828						
125-315	4	✓		15	A	150	125	140	355	176	160L	130	380	110	940	-	230	230	670	730	4xM24	92	1326	462						
		✓		18.5							180M	175											1346	516						
		✓	✓	22							180L	190											1384	532						
		✓	✓	30							200L	255											1444	613						
		✓	✓	37							225SC	315											1490	678						
		✓	✓	45							225MC	330											1515	703						
			✓	55							250MC	450											1595	828						
			✓	75							280SB	566											1711	955						
																							1060	270	270			104	1711	955
125-400	4	✓		22	A	150	125	140	400	218	180L	190	415	110	940	-	230	230	670	730	4-M24	92	1384	580						
		✓		30							200L	255											1444	661						
		✓		37							225SC	315											1490	728						
		✓	✓	45							225MC	330											1515	754						
		✓	✓	55							250MC	450											1595	901						
		✓	✓	75							280SB	566											1711	1040						
			✓	90							280MB	624											1761	1104						
			✓	110							315SB	800											1920	1338						
			✓	132							315MB	900											1970	1448						
		125-500	4	✓								30											A	150	125	180	450	365	200L	255
✓				37	225SC	315	1670	908																						
✓	✓			45	225MC	330	1695	933																						
✓	✓			55	250MC	450	1775	1071																						
✓	✓			75	280SB	566	1891	1226																						
✓	✓			90	280MB	624	1941	1290																						
✓	✓			110	315SB	800	2100	1535																						
	✓			132	315MB	900	2150	1645																						
	✓			160	315LB	990	2250	1762																						
150-200	4			✓		4	A	200	150	160	355	154	112M	47.5	380	110	940	-	230	230	670	730							4xM24	92
		✓		5.5	132S	64							1099	358																
		✓	✓	7.5	132M	78							1137	374																
		✓	✓	11	160M	105							1242	410																
		✓	✓	15	160L	130							1286	437																
			✓	18.5	180M	175							1306	488																
			✓	22	180L	190							1344	508																
150-250	4	✓		15	A	200	150	160	375	171	160L	130	380	110	940	-	230	230	670	730	4xM24	92	1346	457						
		✓		18.5							180M	175											1366	510						
		✓		22							180L	190											1404	527						
		✓	✓	30							200L	255											1464	607						
		✓	✓	37							225SC	315											1510	672						
		✓	✓	45							225MC	330											1535	698						
			✓	55							250MC	450											1615	822						
			✓	75							280SB	566											1731	950						
																							1060	270	270			104	1731	950
150-315	4	✓		18.5	A	200	150	160	400	225	180M	175	415	110	940	-	230	230	670	730	4xM24	92	1366	571						
		✓		22							180L	190											1404	588						
		✓		30							200L	255											1464	669						
		✓	✓	37							225SC	315											1510	736						
		✓	✓	45							225MC	330											1535	761						
		✓	✓	55							250MC	450											1615	909						
		✓	✓	75							280SB	566											1731	1058						
			✓	90							280MB	624											1781	1122						
			✓	110							315SB	800											1940	1346						
			✓	132							315MB	900											1990	1456						

※1) Up to 55kW: EBARA motor  
more than 75kW: TECO motor(AESV)

**DIMENSIONS - Dimensions of Pump with motor(4P)**

GS PUMP-4P 50Hz/60Hz ✓ : Applicable Doc.No.6312-W69093\_rev0

Model	Pole	Hz		Power kW	Fig	Size			Pump		Motor ※(1)		Baseplate										Total (Approx.)						
		50	60			φ 1	φ 2	a	h2	Mass (kg)	Frame	Mass (kg)	h1	BJ	BM1	BM2	BN1	BN2	BY	BW	nxFd	Mass (kg)	L	Mass (kg)					
150-400	4	✓		37	A	200	150	160	450	339	225SC	315	415	110	940	-	230	230	670	730	4xM24	92	1510	861					
		✓		45							225MC	330			1060		270	270				104	1535	887					
		✓		55							250MC	450			270		270	104				1615	1035						
		✓		75							280SB	566			270		270	104				1731	1173						
		✓		90							280MB	624			270		270	104				1781	1237						
150-400L	4		✓	55	A	200	150	160	450	363	250MC	450	415	110	1060	270	270	670	730	4xM24	104	1755	1061						
			✓	75							280SB	566			1200	-	300				300	117	1871	1215					
			✓	90							280MB	624			300	300	117				1921	1288							
			✓	110	B						200	150	160	450	363	315SB	800	465	115	790	790	115	115	630	690	6xM20	190	2080	1502
			✓	132												315MB	900			845	845						200	2130	1612
			✓	160												315LB	990			225	2250						1735		
			✓	200												315LB	1160			104	1775						1210		
150-500	4	✓		55	A	200	150	180	560	491	250MC	450	475	110	1060	270	270	670	730	4xM24	104	1775	1210						
		✓		75							280SB	566			1200	-	300				300	117	1891	1365					
		✓		90							280MB	624			300	300	117				1941	1429							
		✓		110							315SB	800			790	790	220				2100	1673							
		✓	✓	132							315MB	900			790	790	220				2150	1796							
		✓	✓	160	B						200	150	180	560	491	315LB	990	525	115	845	845	115	115	630	690	6xM20	225	2250	1900
			✓	200												315LB	1160			2087									
			✓	220												355MB	1550			2643									
			✓	250												355MB	1650			2753									
			✓	315												355LB	1900			3028									
			✓	375												355CB	2340												
200-400	4	✓		75	B	250	200	180	560	508	280SB	566	535	220	650	650	680	740	6xM20	235	1891	1449							
		✓		90							280MB	624			740	740				1941	1513								
		✓		110							315SB	800			795	795				220	220	280	2100	1752					
		✓	✓	132							315MB	900			220	220				290	2250	1875							
		✓	✓	160							315LB	990			290	2250				1984									
		✓	✓	200							315LB	1160	2183																
		✓	✓	220							355MB	1550	2712																
		✓	✓	250							355MB	1650	2822																
		✓	✓	315							355LB	1900	3097																
		✓	✓	375							355CB	2340	3643																
		200-500	4	✓								160	B	250	200	200	630	645	315LB	990	585	220	870	870	680	740	6xM20	260	2420
✓				200	315LB	1160	2304																						
✓				220	355MB	1550	2843																						
✓	✓			250	610	220	355MB	1650	975	975	220	220							755	825	6xM22	370	2669	2953					
✓	✓			315			355LB	1900	2671	3249																			
✓	✓			375			355CB	2340	380	2861	3743																		
✓	✓			375			355CB	2340	1070	1070																			

※1) Up to 55kW: EBARA motor  
more than 75kW: TECO motor(AESV)

**CONSTRUCTION - Sectional view (Mechanical Seal Type)**

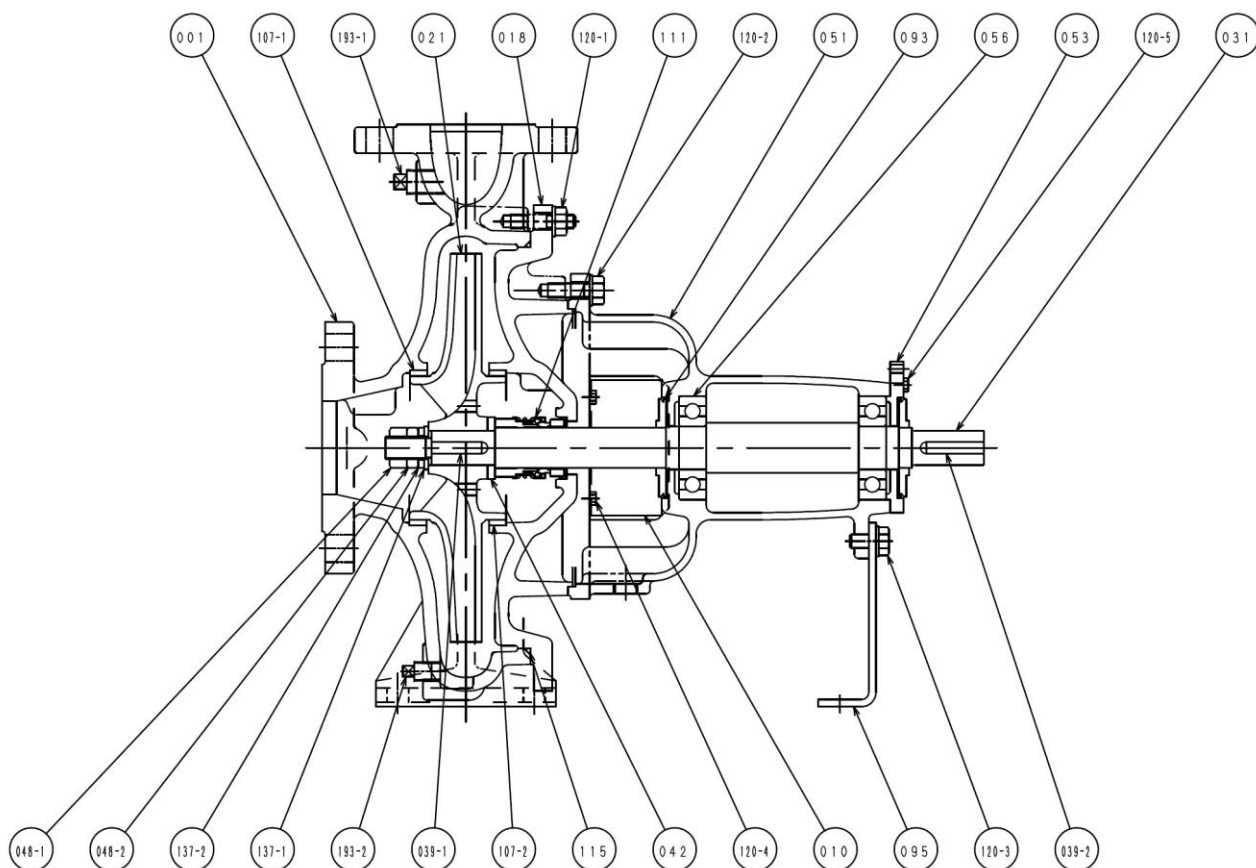

**Mechanical Seal Type**

No.	Part name	Qty
001	CASING	1
010	PROTECTOR	2
018	CASING COVER	1
021	IMPELLER	1
031	SHAFT	1
039-1	KEY	1
039-2	KEY	1
042	SPACER	1
048-1	IMPELLER NUT (A)	1
048-2	IMPELLER NUT (B)	1
051	BEARING HOUSING	1
053	BEARING COVER	1
056	BALL BEARING	2
093	DEFLECTOR	2

No.	Part name	Qty
095	STAY	1
107-1	CASE WEAR RING	1
107-2	CASE WEAR RING	1
111	MECHANICAL SEAL	1
115	O-RING	1
120-1	BOLT	-
120-2	BOLT	6
120-3	BOLT	1
120-4	BOLT	4
120-5	BOLT	4
137-1	PLAIN WASHER	1
137-2	SPRING LOCK WASHER	1
193-1	PLUG	1
193-2	PLUG	1

**CONSTRUCTION - Sectional view (Gland Packing Type)**

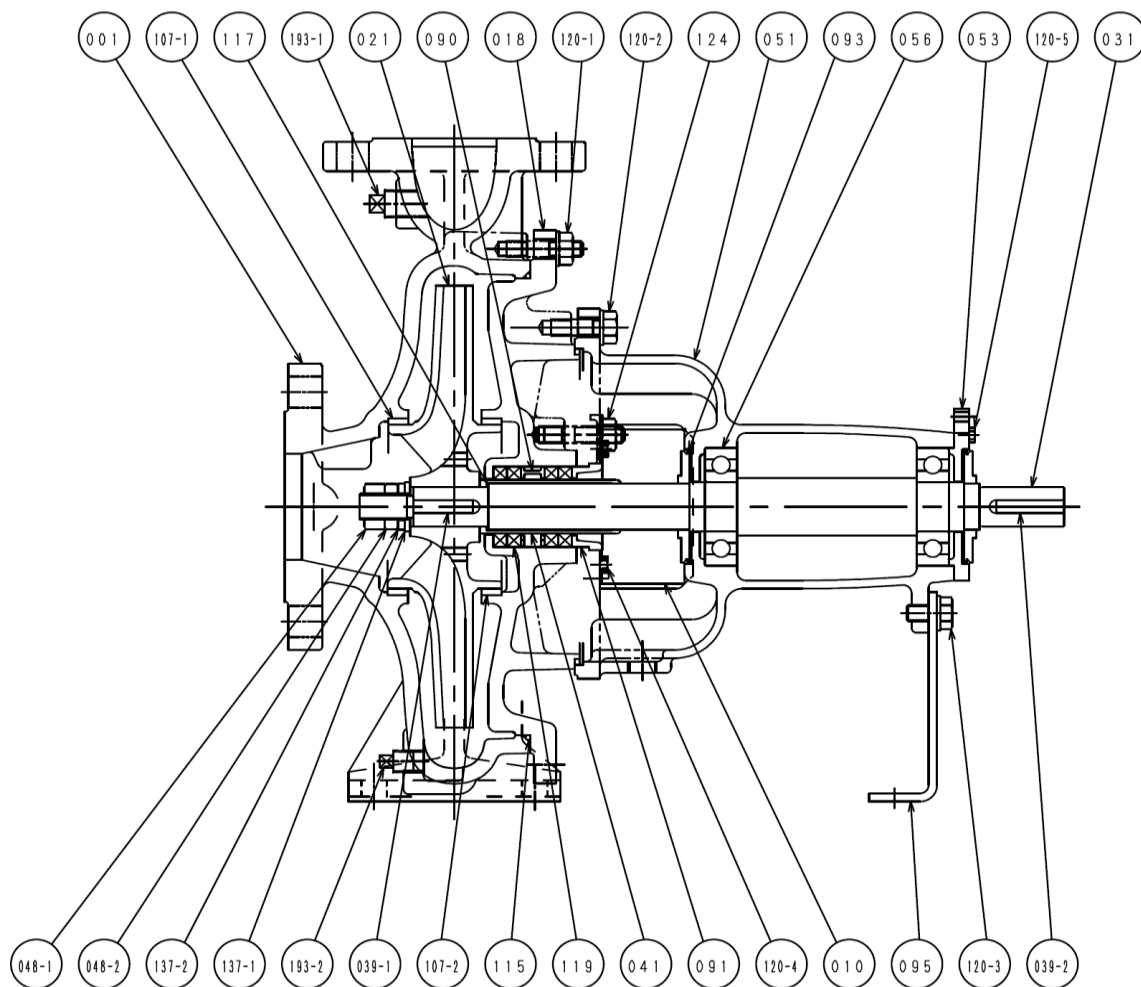

**Gland Packing Type**

No.	Part name	Qty
001	CASING	1
010	PROTECTOR	2
018	CASING COVER	1
021	IMPELLER	1
031	SHAFT	1
039-1	KEY	1
039-2	KEY	1
041	SHAFT SLEEVE	1
048-1	IMPELLER NUT (A)	1
048-2	IMPELLER NUT (B)	1
051	BEARING HOUSING	1
053	BEARING COVER	1
056	BALL BEARING	2
090	LANTERN RING	1
091	GLAND	1
093	DEFLECTOR	2

No.	Part name	Qty
095	STAY	1
107-1	CASE WEAR RING	1
107-2	CASE WEAR RING	1
115	O-RING	1
117	GASKET	1
119	GLAND PACKING	4
120-1	BOLT	-
120-2	BOLT	6
120-3	BOLT	1
120-4	BOLT	4
120-5	BOLT	4
124	GLAND BOLT	2
137-1	PLAIN WASHER	1
137-2	SPRING LOCK WASHER	1
193-1	PLUG	1
193-2	PLUG	1

No.	Name of part	Material	JIS Material	ASTM equivalent	ISO or EN equivalent	Remarks	Material group			
							G1	G2	G3	G4
001	CASING	Cast iron	FC250	A278-35	EN-GJL-250(EN-JL1040)		●	●	●	●
010	PROTECTOR	Ductile cast irons	FCD400	A536-60-40-18	EN-GJS-400-15(5.3106)		○	○	○	○
		Carbon steel	SPPC	A569	DC01(1.0330)		●	●	●	●
018	CASING COVER (conical)	Cast iron	FC250	A278-35	EN-GJL-250(EN-JL1040)		●	●	●	●
		Ductile cast irons	FCD400	A536-60-40-18	EN-GJS-400-15(5.3106)		○	○	○	○
021	IMPELLER	Cast iron	FC200	A278-30	EN-GJL-200(EN-JL1030)		●	●	●	●
		Ductile cast irons	FCD400	A536-60-40-18	EN-GJS-400-15(5.3106)	(*1)				
031	SHAFT	Bronze	CAC406	B584-C83600	CuSn5Zn5Pb5(CC491K)		●	●	●	●
		304 Stainless steel	SCS13	A351-CF8	GX5CrNi19-10(1.4308)					○
039-1	KEY	Cr. steel	SUS431eq.	A276-431	X17CrNi16-2(1.4057)	or SUS420J2/A276-420 eq. / X30Cr13 (1.4028) eq.	●	●	●	●
		Duplex stainless steel	SUS329J3L /S35C	A276-S31803 /Grade1035	X2CrNiMoN22-5-3(1.4462) /C35	(*3)				○
039-2	KEY	12% Cr. steel	SUS420J2	A276-420	X30Cr13(1.4028)		●	●	●	●
042	SPACER	316 Stainless steel	SUS316	A276-316	X5CrNiMo17-12-2(1.4401)		●	●	●	●
		Carbon steel	S50C	A576-1050	C50(1.0540)		●	●	●	●
048-1	IMPELLER NUT (A)	304 Stainless steel	SUS304	A276-304	X5CrNi18-10(1.4301)		●	●	●	●
048-2	IMPELLER NUT (B)	304 Stainless steel	SUS304	A276-304	X5CrNi18-10(1.4301)		●	●	●	●
051	BEARING HOUSING	Cast iron	FC150	A48-20	EN-GJL-150(EN-JL1020)		●	●	●	●
		Cast iron	FC150	A48-20	EN-GJL-150(EN-JL1020)		●	●	●	●
056	BALL BEARING	Steel	---	---	---	(*4)	●	●	●	●
093	DEFLECTOR	EPDM	---	---	---		●	●	●	●
095	STAY	Carbon steel	SPHC	A569	---		●	●	●	●
		Bronze	CAC406	B584-C83600	CuSn5Zn5Pb5(CC491K)		●	●	●	●
107	CASE WEAR RING	Cast iron	FC150	A48-20	EN-GJL-150(EN-JL1020)		●	●	●	●
		Sic/carbon/FKM	---	---	---	Elastomer bellows seal O ring/Spring	●	●	●	●
111	MECHANICAL SEAL	Sic/carbon/EPDM	---	---	---		○	○	○	○
		Tc/carbon/EPDM	---	---	---		○	○	○	○
115	O-RING	Sic/Sic/	---	---	---		○	○	○	○
		NBR	---	---	---		○	○	○	○
120	BOLTS	FKM	---	---	---	Viton	○	○	○	○
		EPDM	---	---	---		○	○	○	○
137-1	PLAIN WASHER	Carbon steel	SS	A283-D	---		●	●	●	●
		304 Stainless steel	SUS304	A276-304	X5CrNi18-10(1.4301)		●	●	●	●
137-2	SPRING LOCK WASHER	304 Stainless steel	SUS304	A276-304	X5CrNi18-10(1.4301)		●	●	●	●
		Carbon steel	SS	A283-D	---		●	●	●	●
193-1	PLUG	Carbon steel	SS	A283-D	---		●	●	●	●
193-2	PLUG	Carbon steel	SS	A283-D	---		●	●	●	●

Materials of mechanical seal application ( conical type )

● : Standard ○ : Optional

(\*1) Except pumps model GS100-400, 125-400, 125-500, 150-400, 150-500, 200-400 and 200-500, impellers made of cast iron are applied for all pumps.  
 (\*2) Impellers made of ductile cast iron are applied only the pumps model GS100-400, 125-400, 125-500, 150-400, 150-500, 200-400 and 200-500.  
 (\*3) Duplex stainless steel is used for wetted part only. The remaining atmospheric side of shaft is made of carbon steel.  
 (\*4) Deep groove ball bearing, single row / Vacuum degassed steel

**Materials of gland packing application (\*5)**

● : Standard ○ : Optional

No.	Name of part	Material	JIS Material	ASTM equivalent	ISO or EN equivalent	Remarks	Material group			
							G1	G2	G3	G4
018	CASING COVER (cylindrical)	Cast iron	FC250	A278-35	EN-GJL-250(EN-JL1040)		●	●	●	●
041	SHAFT SLEEVE	304 Stainless steel	SUS304	A276-304	X5CrNi18-10(1.4301)		●	●	●	●
090	LANTERN RING	Cast iron	FC150 or 200	A48-20 or 30	EN-GJL-150(EN-JL1020) or EN-GJL-200(EN-JL1030)			○		
091	GLAND	Bronze	CAC406	B584-C83600	CuSn5Zn5Pb5(CC491K)		●		●	
		304 Stainless steel	SCS13	A351-CF8	GX5CrNi19-10(1.4308)				○	
		Cast iron	FC150	A48-20	EN-GJL-150(EN-JL1020)					○
		Bronze	CAC406	B584-C83600	CuSn5Zn5Pb5(CC491K)		●		●	
117	GASKET	304 Stainless steel	SCS13	A351-CF8	GX5CrNi19-10(1.4308)					○
119	GLAND PACKING	Joint sheet gasket	---	---	---	V#6500AC eq.	●	●	●	●
		Silicone carbide fiber packing	---	---	---	P#6501L or P#6502L	●	●	●	●
124	GLAND BOLT	12% Cr. steel	SUS403	A276-403	---					
		Brass	C3604BD	B16-C36000	---				○	
		304 Stainless steel	SUS304	A276-304	X5CrNi18-10(1.4301)		●			○

(\*5) The components which constitute the gland packing pump are these parts instead of P/N 018, 042 and 111of the mechanical seal pump.

**Explanation of Material Group**

Material Group	Casing, 001 and Casing Cover, 018	Impeller, 021	Case Wear Ring, 107	Shaft, 031	Notes	
G1	Casting, 001 and Casing Cover, 018  Cast iron or Ductile cast irons	Cast iron or Ductile cast irons	Bronze	Cr.steel	Cast iron impeller with Bronze case wear ring	
G2		Cast iron or Ductile cast irons	Cast iron	Cr.steel	All wetted parts are iron material.	
G3		Ductile cast irons	Bronze	Bronze	Cr.steel	Bronze impeller with Bronze case wear ring
G4			304 Stainless steel	Cast iron	Duplex stainless steel	Stainless steel impeller with Duplex stainless steel shaft

**CONSTRUCTION - Availability of Materials**

**Material availability depend on pump models and flange rating**

MODEL	CASING, 001/ CASING COVER, 018		IMPELLER, 021				SHAFT SEAL		FLANGE (CASING, 001)				
	MATERIALS												
	CAST IRON	DUCTILE CAST IRON	CAST IRON	DUCTILE CAST IRON	BRONZE	304 STAINLESS STEEL			CAST IRON	DUCTILE CAST IRON	CAST IRON	DUCTILE CAST IRON	
JIS	FC250	FCD400	FC200	FCD400	CAC406	SCS13	MECH. SEAL, 111	GLAND PACKING, 119	EN			JIS	
ASTM eq.	A278-35	A536-60 -40-18	A278-30	A536-60 -40-18	B584 C83600	A351-CF8			PN10	PN16	PN25	10K	20K
32-125.1	□	-	□	-	□	□	□	□	□	□	-	□	-
32-160.1	□	-	□	-	□	□	□	□	□	□	-	□	-
32-200.1	□	-	□	-	□	□	□	□	□	□	-	□	-
32-125	□	-	□	-	□	□	□	□	□	□	-	□	-
32-160	□	-	□	-	□	□	□	□	□	□	-	□	-
32-200	□	-	□	-	□	□	□	□	□	□	-	□	-
32-250	□	-	□	-	□	□	□	□	□	□	-	□	-
40-125	□	-	□	-	□	□	□	□	□	□	-	□	-
40-160	□	-	□	-	□	□	□	□	□	□	-	□	-
40-200	□	-	□	-	□	□	□	□	□	□	-	□	-
40-250	□	-	□	-	□	□	□	□	□	□	-	□	-
40-315	□	-	□	-	□	-	□	□	□	□	-	□	-
50-125	□	-	□	-	□	□	□	□	□	□	-	□	-
50-160	□	-	□	-	□	□	□	□	□	□	-	□	-
50-200	□	-	□	-	□	□	□	□	□	□	-	□	-
50-250	□	-	□	-	□	□	□	□	□	□	-	□	-
50-315	□	-	□	-	□	□	□	□	□	□	-	□	-
65-125	□	-	□	-	□	□	□	□	□	□	-	□	-
65-160	□	-	□	-	□	□	□	□	□	□	-	□	-
65-200	□	-	□	-	□	□	□	□	□	□	-	□	-
65-250	□	-	□	-	□	□	□	□	□	□	-	□	-
65-315	□	-	□	-	□	□	□	□	□	□	-	□	-
80-160	□	◇	□	-	□	□	□	△	□	◇	□	◇	◇
80-200	□	◇	□	-	□	□	□	△	□	◇	□	◇	◇
80-250	□	◇	□	-	□	□	□	△	□	◇	□	◇	◇
80-315	□	◇	□	-	□	□	□	△	□	◇	□	◇	◇
80-315L	□	◇	□	-	□	□	□	△	□	◇	□	◇	◇
80-400	□	◇	□	-	□	□	□	△	□	◇	□	◇	◇
100-160	□	◇	□	-	□	Later	□	△	□	◇	□	◇	◇
100-200	□	◇	□	-	□	Later	□	△	□	◇	□	◇	◇
100-250	□	◇	□	-	□	Later	□	△	□	◇	□	◇	◇
100-250L	□	◇	□	-	□	Later	□	△	□	◇	□	◇	◇
100-315	□	◇	□	-	□	Later	□	△	□	◇	□	◇	◇
100-315L	□	◇	□	-	□	Later	□	△	□	◇	□	◇	◇
100-400	□	◇	-	□	□	Later	□	△	□	◇	□	◇	◇
125-200	□	◇	□	-	□	Later	□	△	□	◇	□	◇	◇
125-250	□	◇	□	-	□	Later	□	△	□	◇	□	◇	◇
125-250L	□	◇	□	-	□	Later	□	△	□	◇	□	◇	◇
125-315	□	◇	□	-	□	Later	□	△	□	◇	□	◇	◇
125-400	□	◇	-	□	□	Later	□	△	□	◇	□	◇	◇
125-500	□	◇	-	□	□	Later	□	△	□	◇	□	◇	◇
150-200	□	◇	□	-	□	Later	□	△	-	□	◇	□	◇
150-250	□	◇	□	-	□	Later	□	△	-	□	◇	□	◇
150-315	□	◇	□	-	□	Later	□	△	-	□	◇	□	◇
150-400	□	◇	-	□	□	Later	□	△	-	□	◇	□	◇
150-400L	□	◇	-	□	□	Later	□	△	-	□	◇	□	◇
150-500	□	◇	-	□	□	Later	□	△	-	□	◇	□	◇
200-400	□	◇	-	□	□	Later	□	△	-	□	◇	□	◇
200-500	□	◇	-	□	□	Later	□	△	-	□	◇	□	◇

□ : Available

◇, △ : Available with the following conditions

◇ : Pumps of ductile cast iron made are applied only the mechanical seal application and flange rating of EN PN25 or JIS20K.

△ : Gland packing installed pumps of ductile cast iron made do not exist.

**Mechanical seal selection of conical type (\*1)**

Description		Standard	Optional	
Liquid temp (*2)		-10~120 °C	-10~120 °C	0~140 °C
Materials (*3)		SiC / C / FKM	SiC / C / EPDM	Tc / C / EPDM (*4)
Max. allowable operating pressure (*5)(*6)	Shaft no. 230,240,250,260	-0.5~24.5 bar (-0.05~2.45MPa)	-0.5~16 bar (-0.05~1.6MPa)	-0.2~25 bar (-0.02~2.5MPa)
	Shaft no. 270,280	-0.5~16 bar (-0.05~1.6MPa)		

(\*1) This table shows only the EBARA standard type mechanical seal. If you want mechanical seal with other types or material combinations, please contact engineering center.

(\*2) Please contact engineering center for the application of low temperature mechanical seal.

(\*3) SiC : silicon carbide / Tc : Tungsten carbide / C : carbon

(\*4) It is prohibited to adopt this type mechanical seal for portable water applications.

(\*5) These value show the allowable range of mechanical seal itself.

(\*6) Calculation of P box is based on below equation.

$$P_{box} = (0.05 \times T.H.) + P_s$$

P<sub>box</sub>: Box pressure

T.H.: Total head in pressure (Differential pressure)

P<sub>s</sub>: Suction pressure

**Gland packing**

Gland packing material	Liquid temp (*7)	Shaft no.230,240,250		Shaft no.260,270,280	
		Max.speed	Allowable operating pressure(*7)(*8)	Max.speed	Allowable operating pressure(*7)(*8)
Silicone carbide fiber packing (P#6501L or P#6502L)	0~80°C	3600 min-1	6 bar (0.6 MPa)	1800 min-1	6 bar (0.6 MPa)

(\*7) These value show the allowable range of gland packing itself.

(\*8) Calculation of P box is based on below equation.

$$P_{box} = (0.05 \times T.H.) + P_s$$

P<sub>box</sub>: Box pressure

T.H.: Total head in pressure (Differential pressure)

P<sub>s</sub>: Suction pressure



SELECTION CHART

50Hz – 2900min<sup>-1</sup>

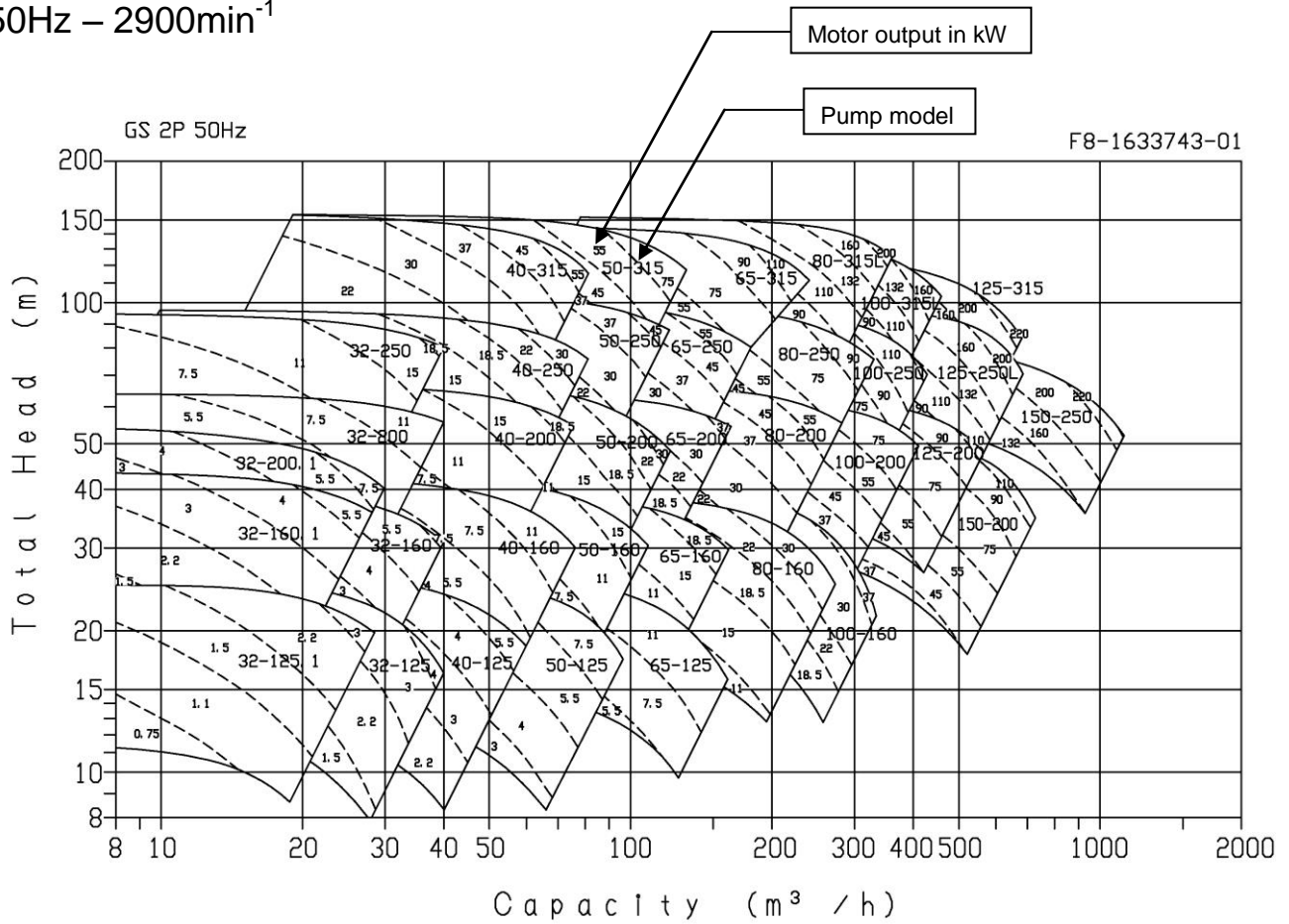

Note1 : The values inside the broken lines are motor output(kW) in case of density 1.0kg/ℓ and viscosity 1.0mPa · s.

Note2 : The indicated motor output(kW) value includes the following safety margins ;

up to 7.5kW : 15%

11kW and above : 10%

Note3 : When selecting a pump , NPSH Av. should have a safety margin of at least 0.5m from NPSH Re.

SELECTION CHART

50Hz – 1450min<sup>-1</sup>

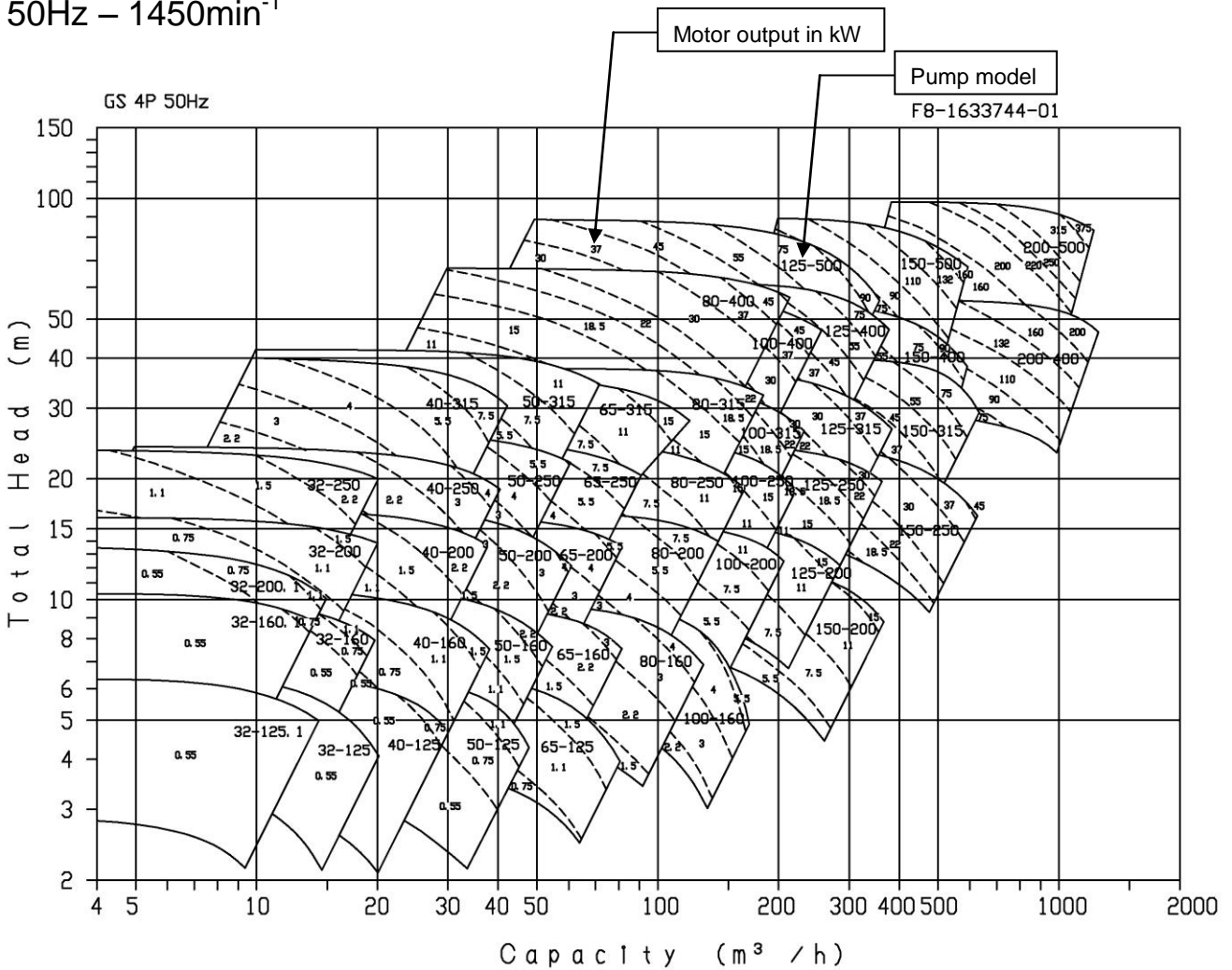

Note1 : The values inside the broken lines are motor output(kW) in case of density 1.0kg/ℓ and viscosity 1.0mPa · s.

Note2 : The indicated motor output(kW) value includes the following safety margins ;

up to 7.5kW : 15%

11kW and above : 10%

Note3 : When selecting a pump , NPSH Av. should have a safety margin of at least 0.5m from NPSH Re.

SELECTION CHART

60Hz – 3500min<sup>-1</sup>

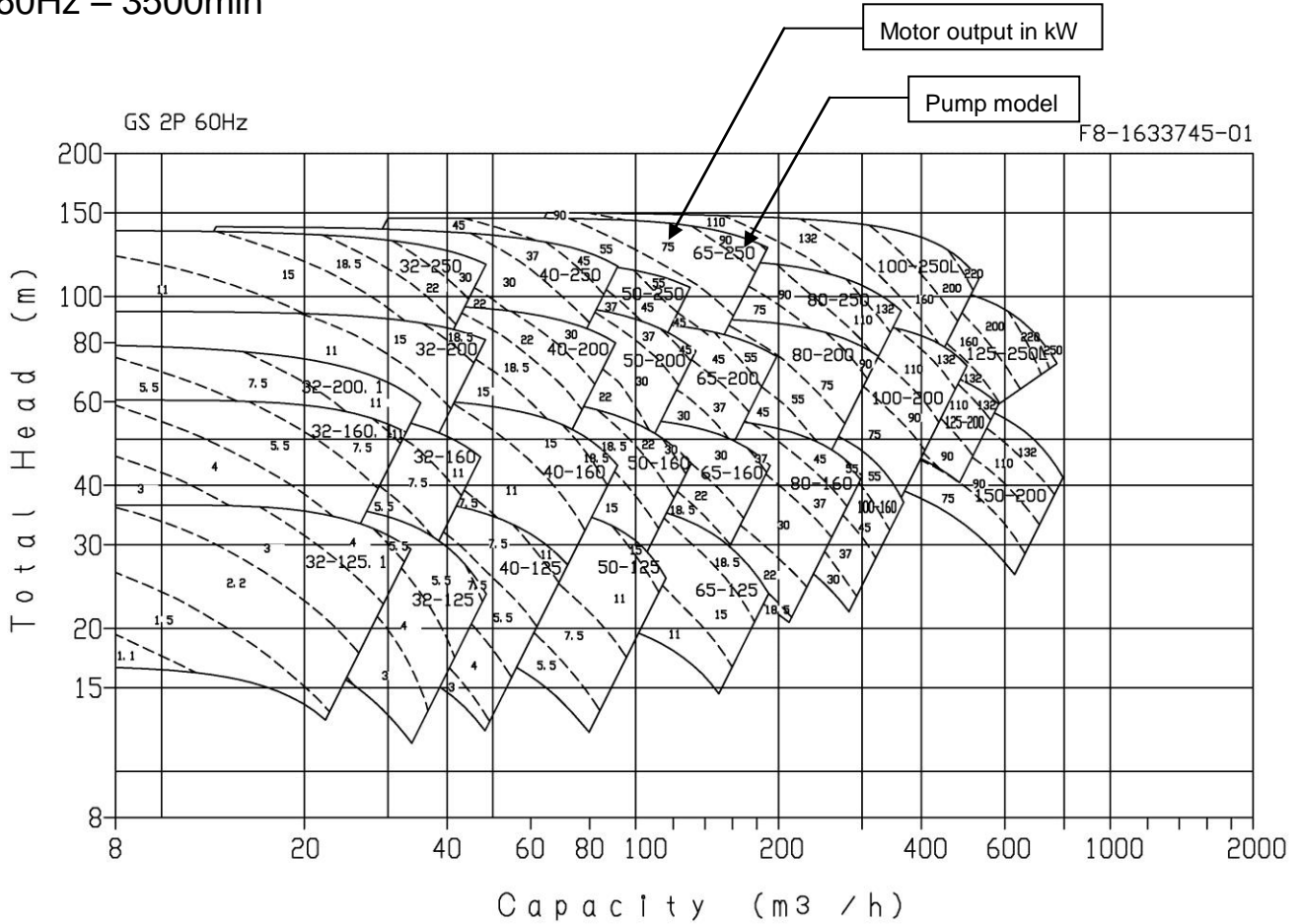

Note1 : The values inside the broken lines are motor output(kW) in case of density 1.0kg/l and viscosity 1.0mPa · s.

Note2 : The indicated motor output(kW) value includes the following safety margins ;

up to 7.5kW : 15%

11kW and above : 10%

Note3 : When selecting a pump , NPSH Av. should have a safety margin of at least 0.5m from NPSH Re.

SELECTION CHART

60Hz – 1750min<sup>-1</sup>

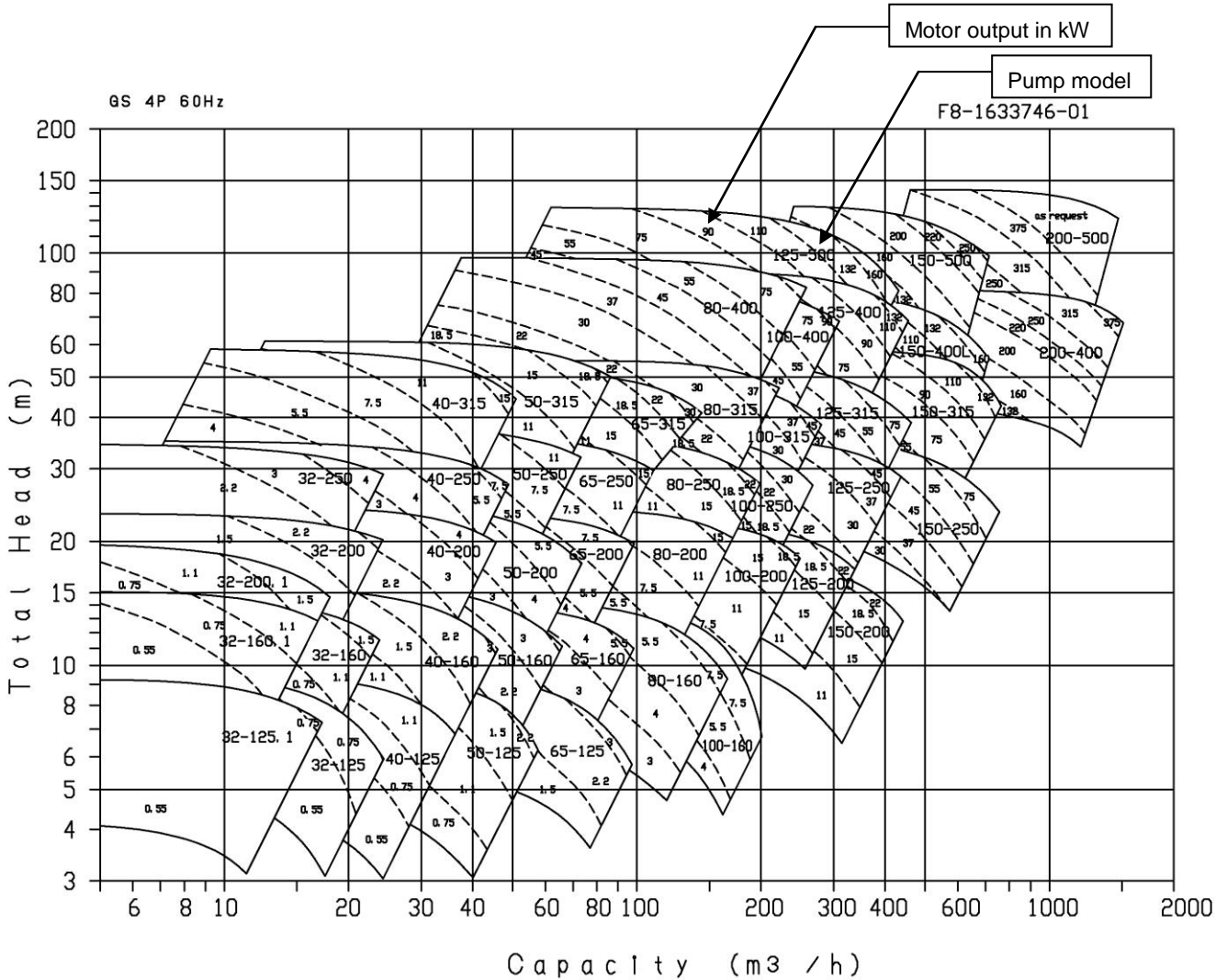

Note1 : The values inside the broken lines are motor output(kW) in case of density 1.0kg/l and viscosity 1.0mPa · s.

Note2 : The indicated motor output(kW) value includes the following safety margins ;

up to 7.5kW : 15%

11kW and above : 10%

Note3 : When selecting a pump , NPSH Av. should have a safety margin of at least 0.5m from NPSH Re.

---

**SELECTION CHART**

Performance Curve

2 Poles

GS32-125.1	According to ISO testing code 9906 Grade 3B
50Hz ( Speed 2900 min <sup>-1</sup> )	DENSITY= 1.0 kg/l , VISCOSITY= 1.0 mPa·s

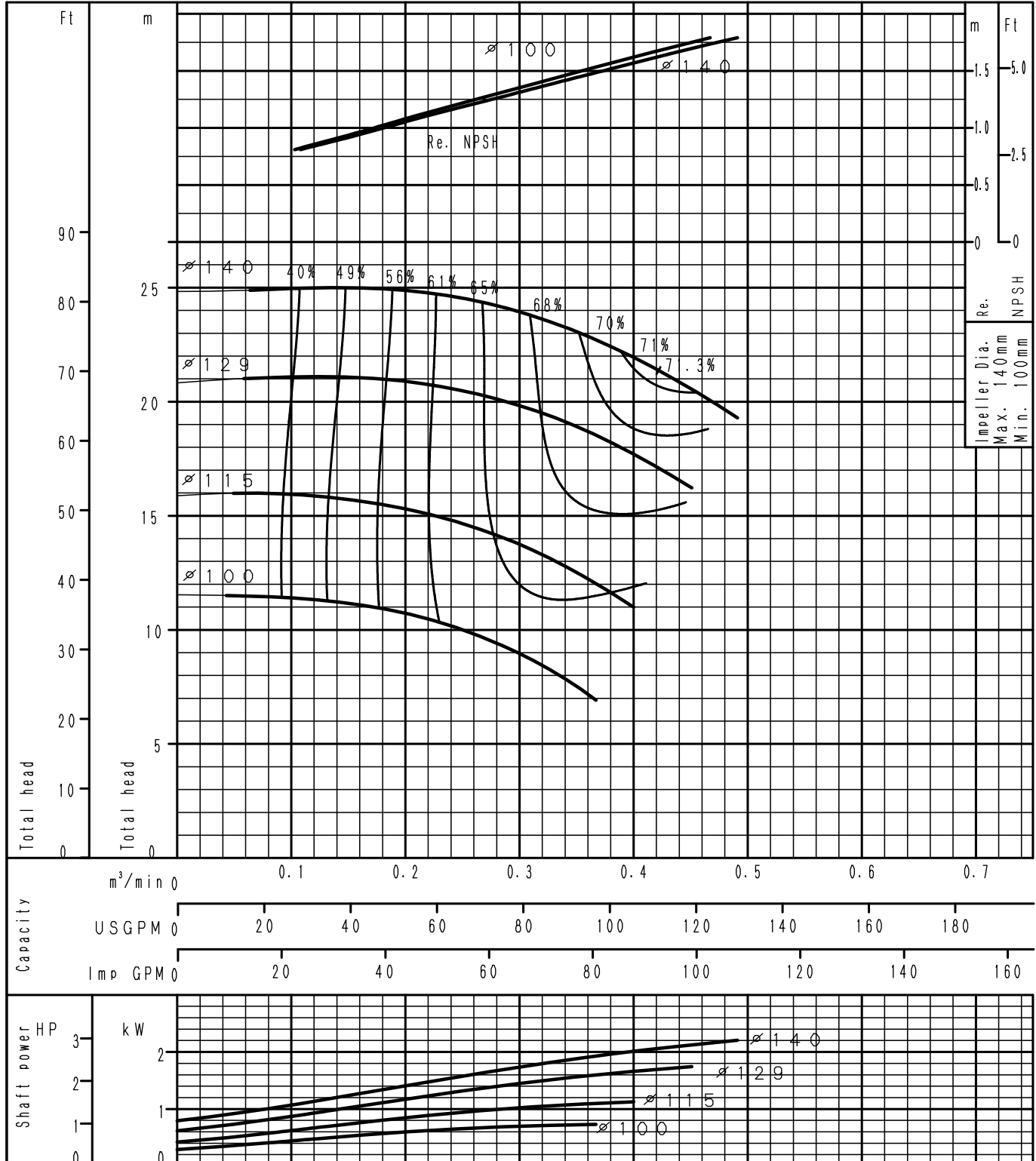

Performance Curve

2 Poles

GS32-160.1	According to ISO testing code 9906 Grade 3B
50Hz ( Speed 2900 min <sup>-1</sup> )	DENSITY= 1.0 kg/l , VISCOSITY= 1.0 mPa·s

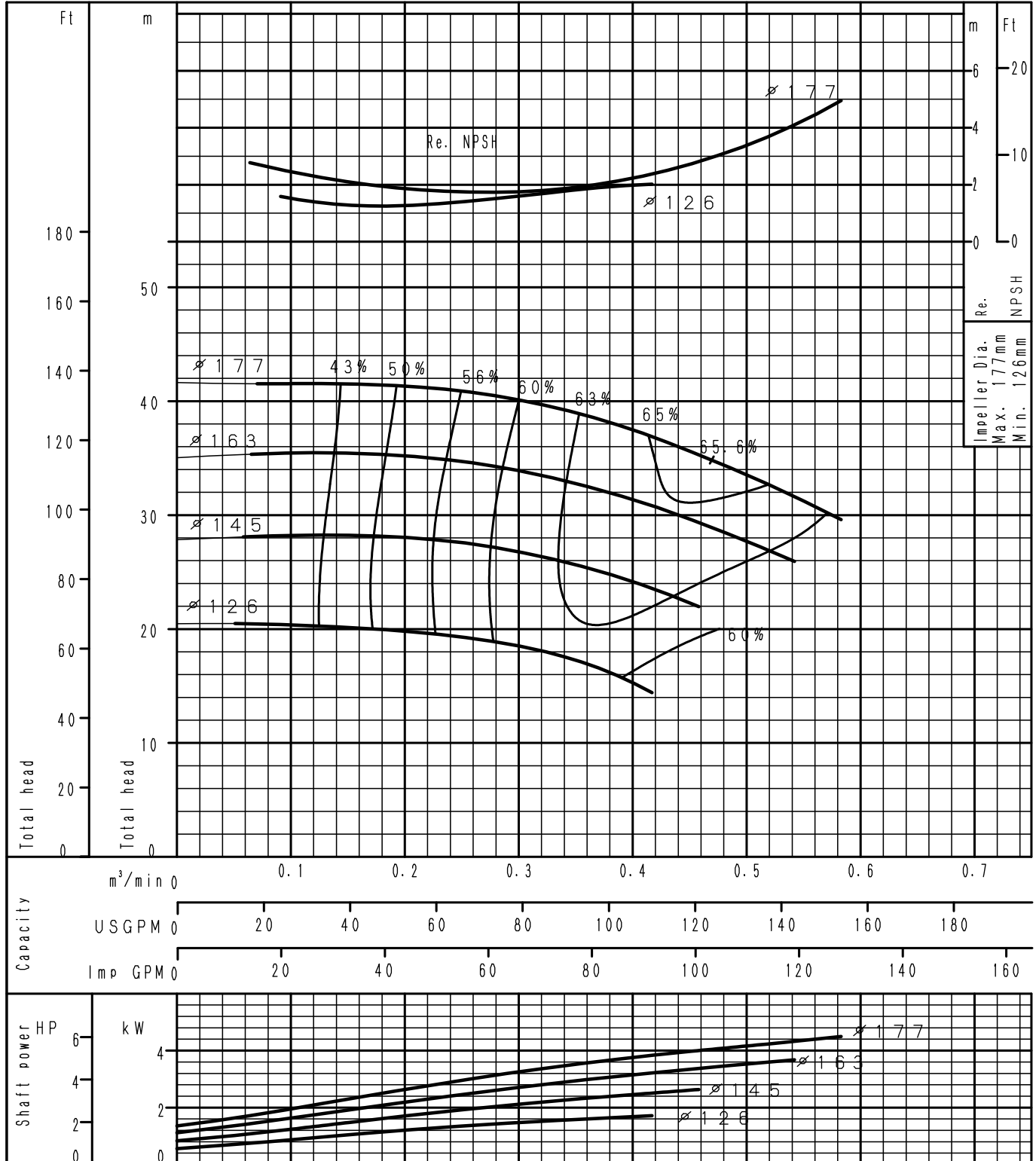

Performance Curve

2 Poles

GS32-200.1	According to ISO testing code 9906 Grade 3B
50Hz ( Speed 2900 min <sup>-1</sup> )	DENSITY= 1.0 kg/l , VISCOSITY= 1.0 mPa·s

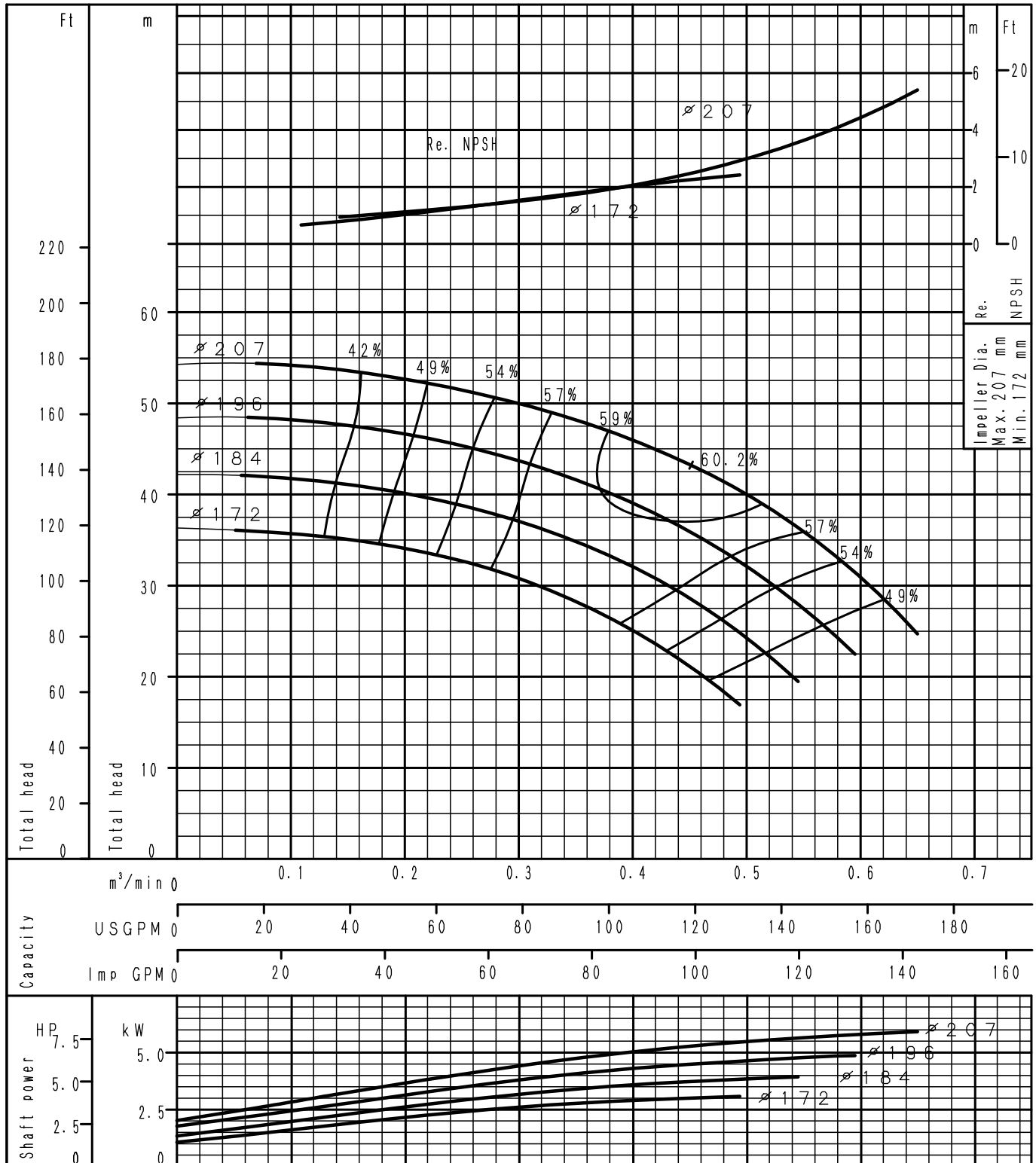



Performance Curve

2 Poles

GS32-125	According to ISO testing code 9906 Grade 3B
50Hz ( Speed 2900 min <sup>-1</sup> )	DENSITY= 1.0 kg/l , VISCOSITY= 1.0 mPa·s

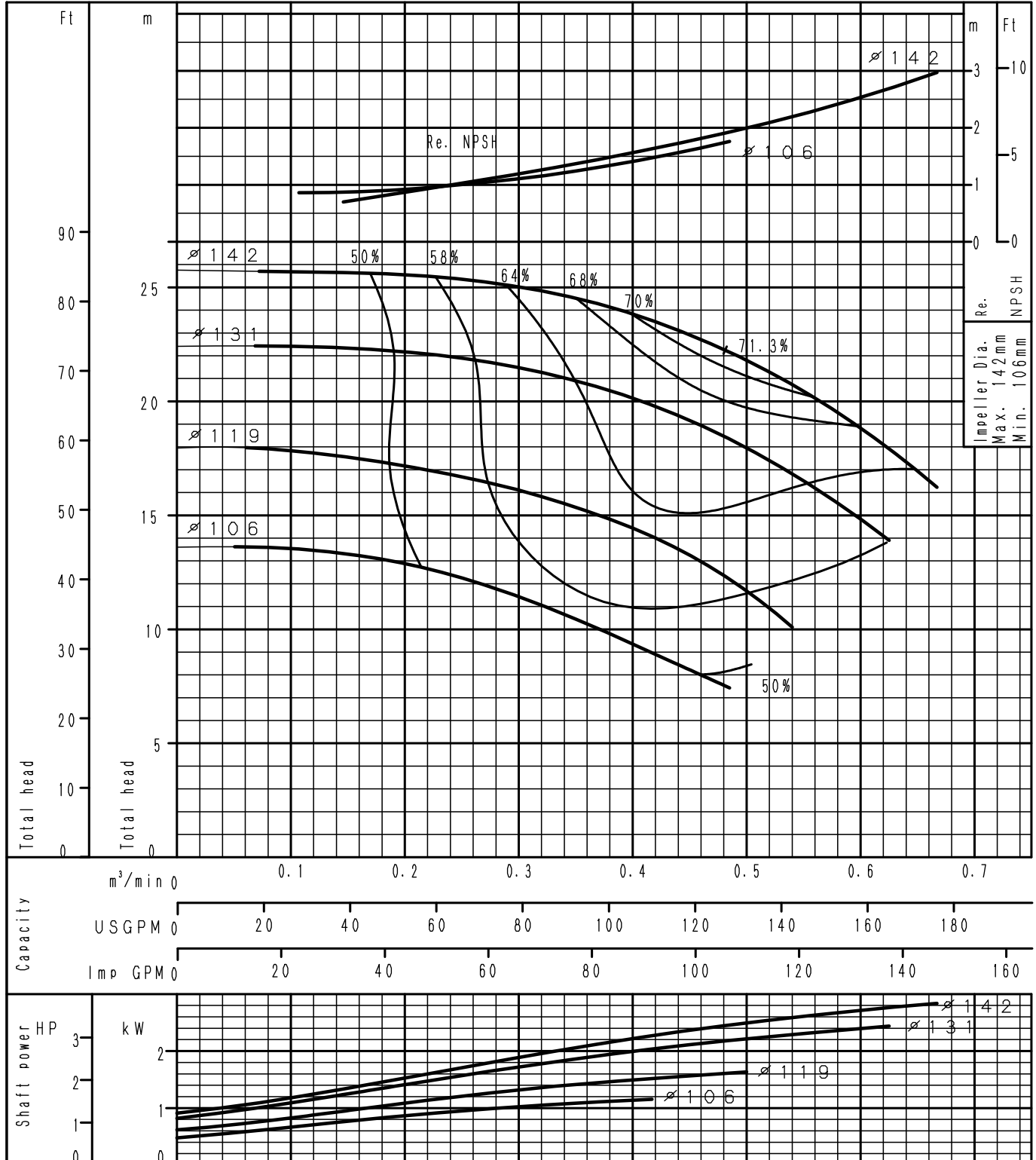

Performance Curve

2 Poles

<h1 style="margin: 0;">GS32-160</h1>	According to ISO testing code 9906 Grade 3B
50Hz ( Speed 2900 min <sup>-1</sup> )	DENSITY= 1.0 kg/l , VISCOSITY= 1.0 mPa·s

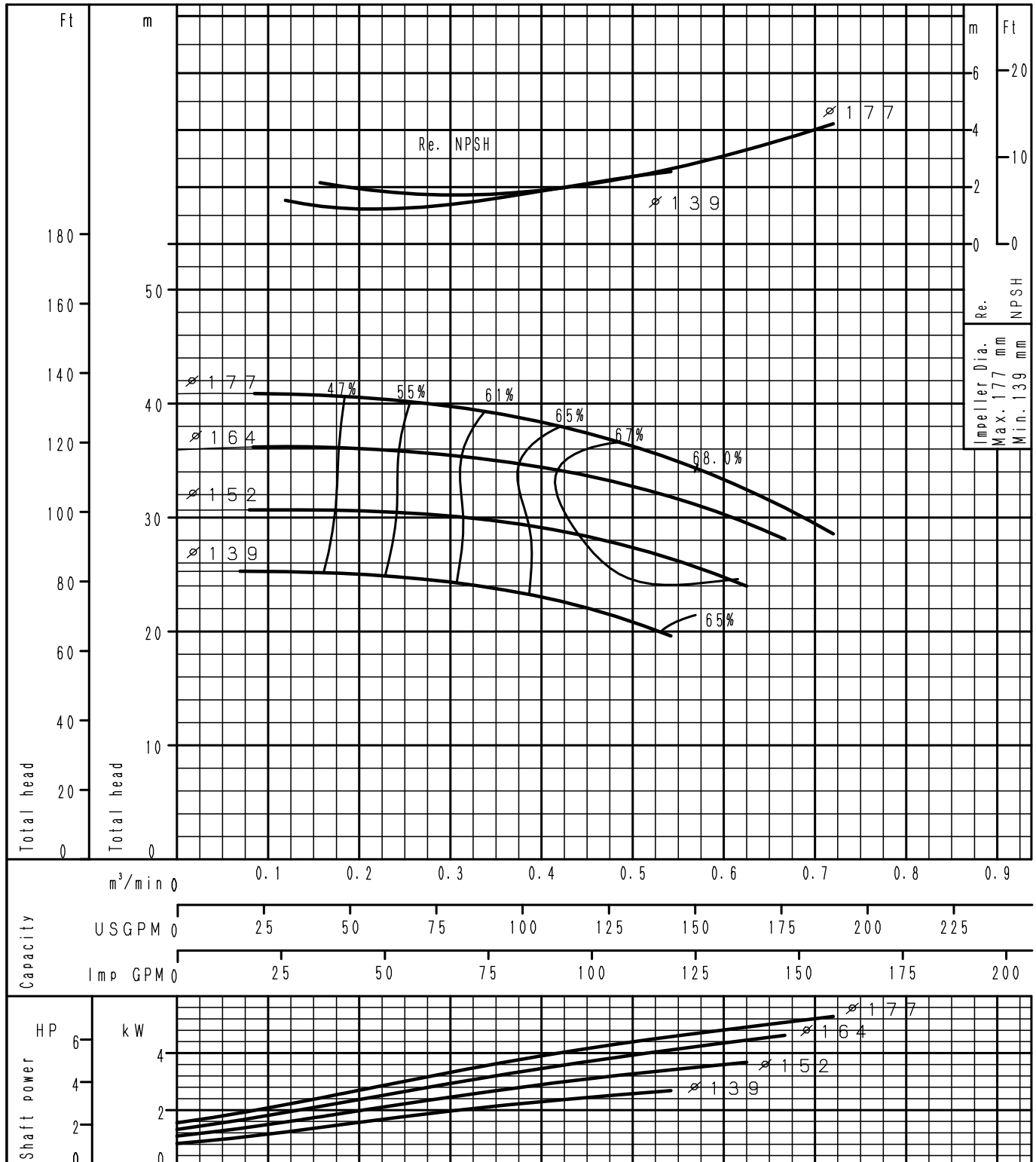

Performance Curve

2 Poles

GS32-200	According to ISO testing code 9906 Grade 3B
50Hz ( Speed 2900 min <sup>-1</sup> )	DENSITY= 1.0 kg/l , VISCOSITY= 1.0 mPa·s

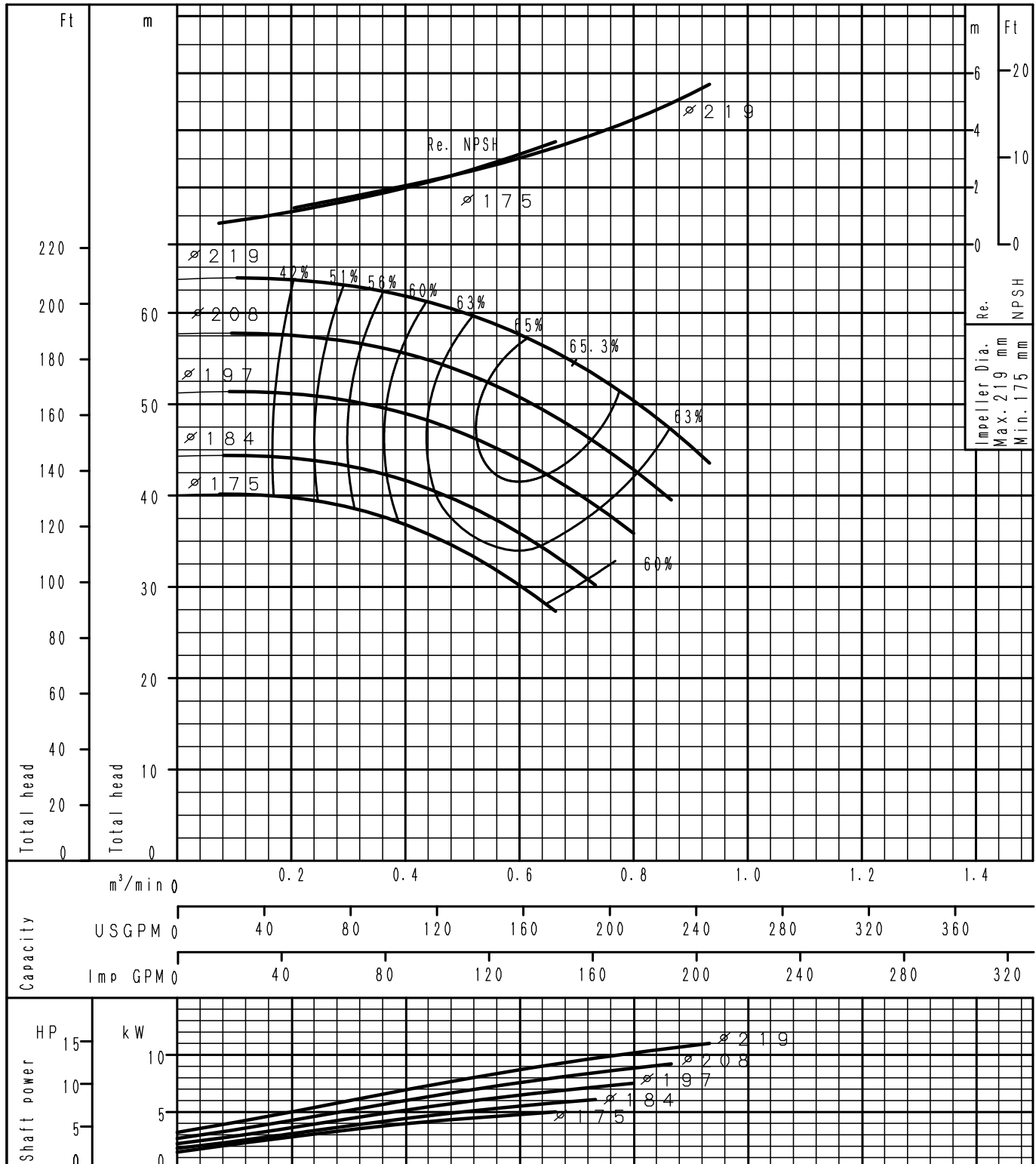

Performance Curve

2 Poles

GS32-250	According to ISO testing code 9906 Grade 3B
50Hz ( Speed 2900 min <sup>-1</sup> )	DENSITY= 1.0 kg/l , VISCOSITY= 1.0 mPa·s

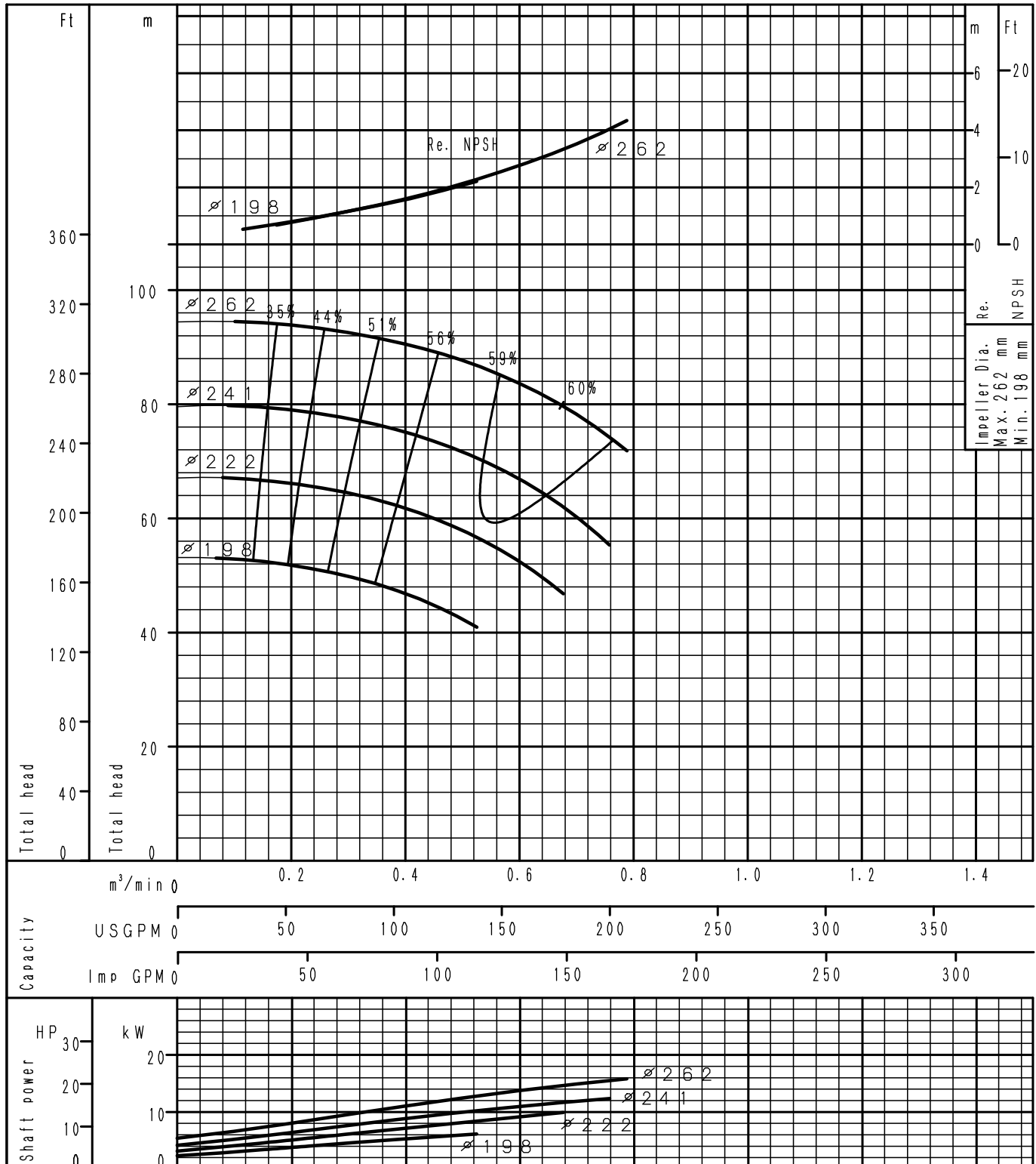

Performance Curve

2 Poles

GS40-125	According to ISO testing code 9906 Grade 3B
50Hz ( Speed 2900 min <sup>-1</sup> )	DENSITY= 1.0 kg/l , VISCOSITY= 1.0 mPa·s

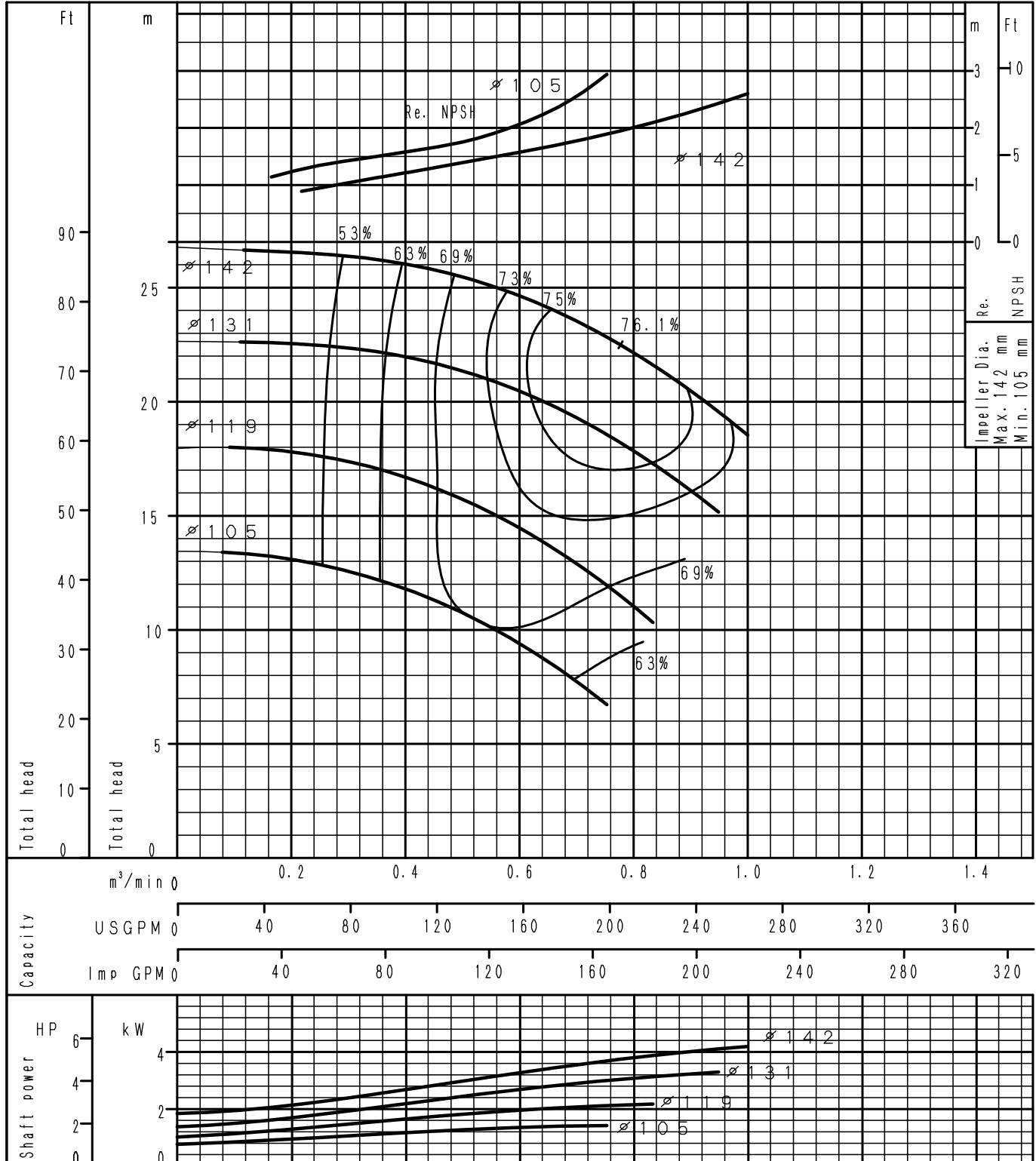

Performance Curve

2 Poles

GS40-160	According to ISO testing code 9906 Grade 3B
50Hz ( Speed 2900 min <sup>-1</sup> )	DENSITY= 1.0 kg/l , VISCOSITY= 1.0 mPa·s

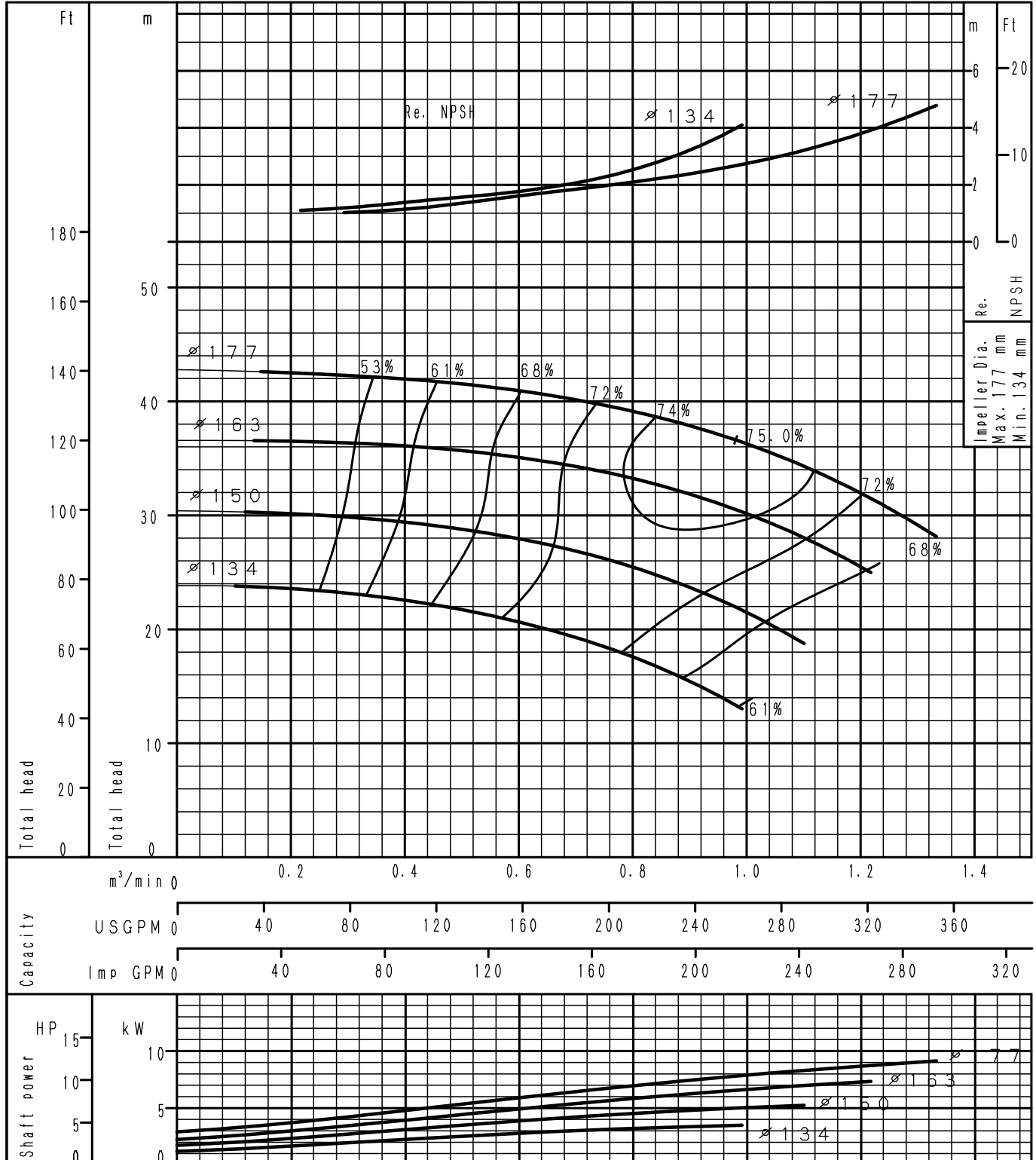

Performance Curve

2 Poles

GS40-200	According to ISO testing code 9906 Grade 3B
50Hz ( Speed 2900 min <sup>-1</sup> )	DENSITY= 1.0 kg/l , VISCOSITY= 1.0 mPa·s

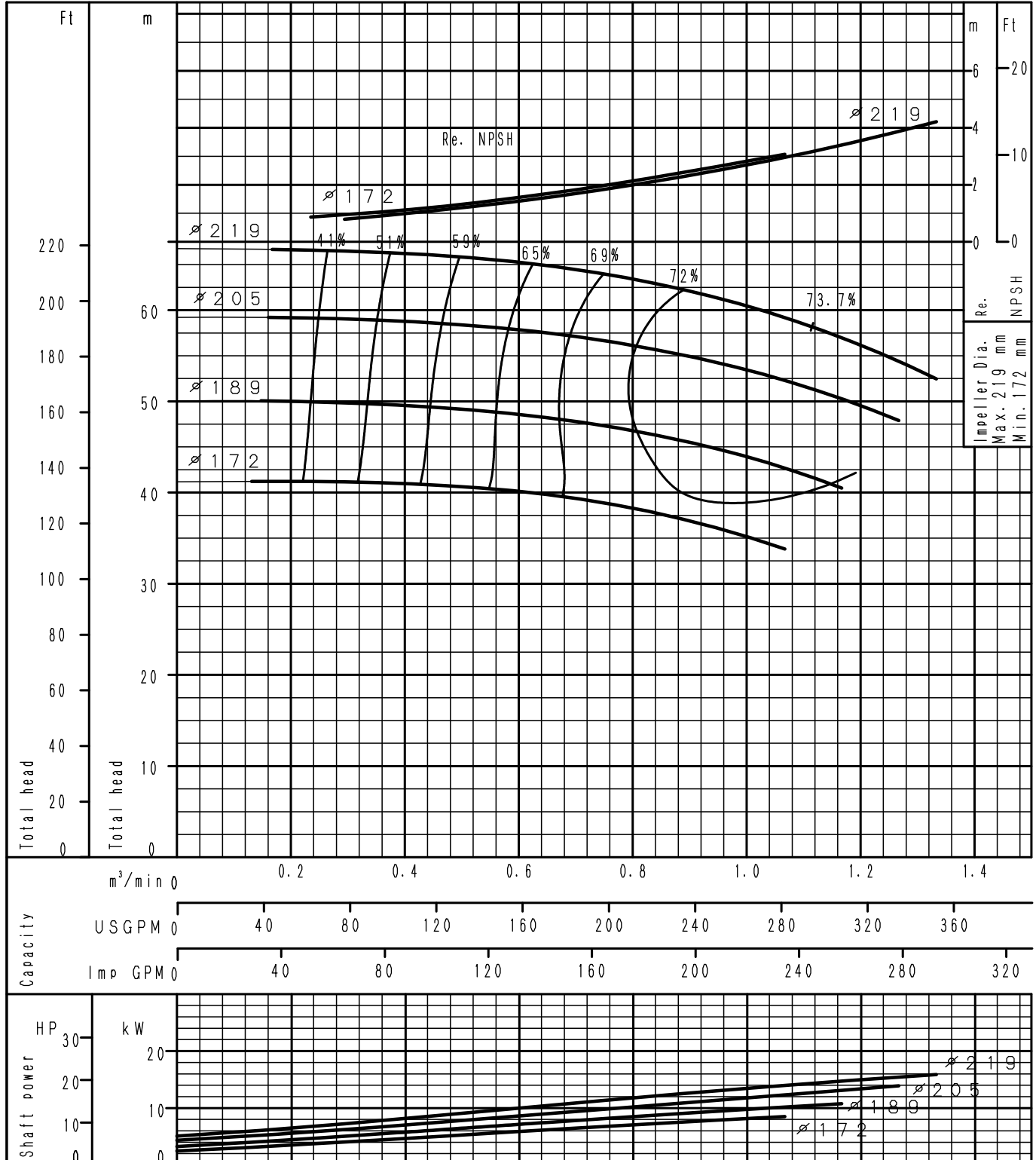

Performance Curve

2 Poles

<h1 style="margin: 0;">GS40-250</h1>	According to ISO testing code 9906 Grade 3B
50Hz ( Speed 2900 min <sup>-1</sup> )	DENSITY= 1.0 kg/l , VISCOSITY= 1.0 mPa·s

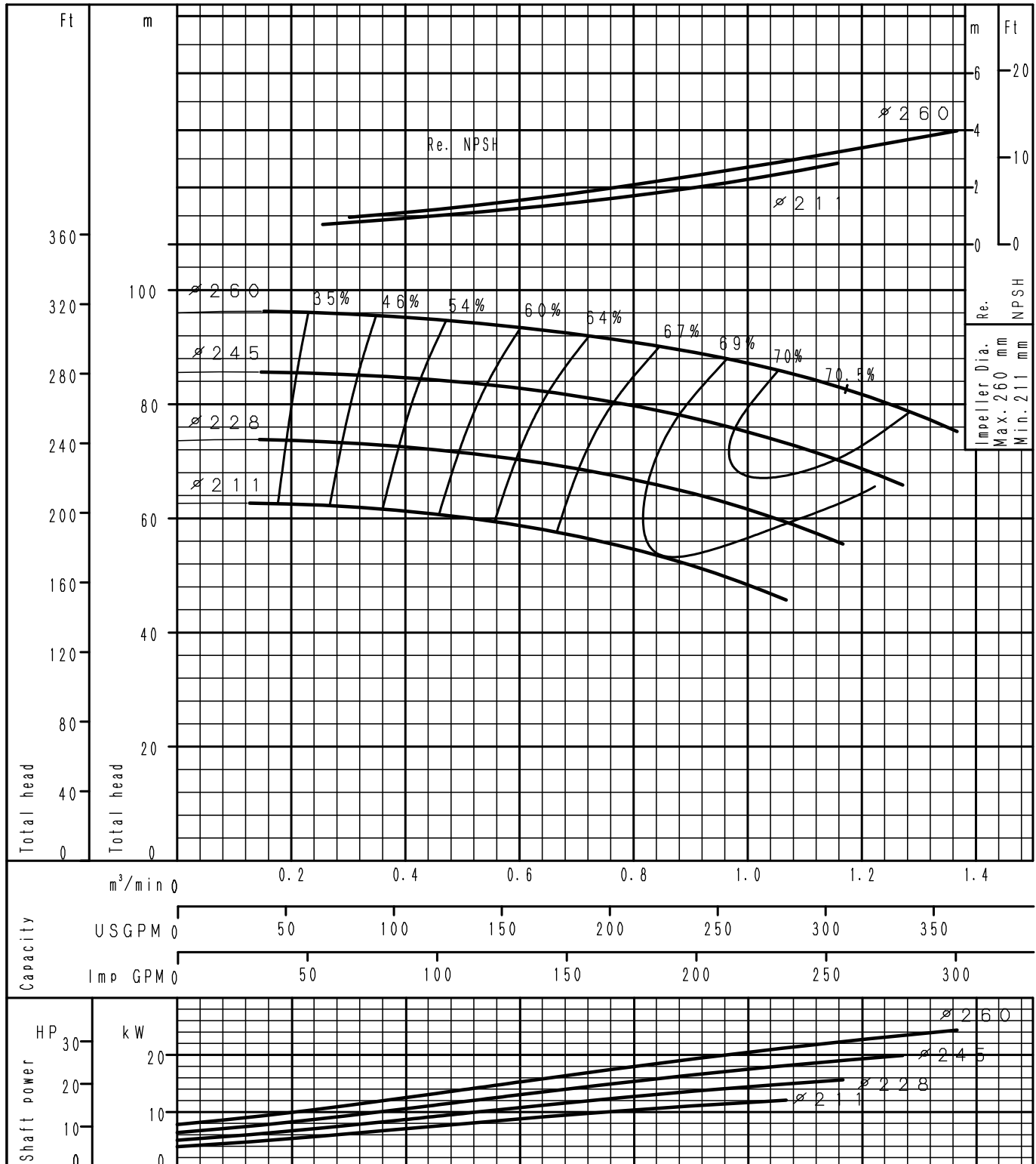



Performance Curve

2 Poles

GS40-315	According to ISO testing code 9906 Grade 3B
50Hz ( Speed 2900 min <sup>-1</sup> )	DENSITY= 1.0 kg/l , VISCOSITY= 1.0 mPa·s

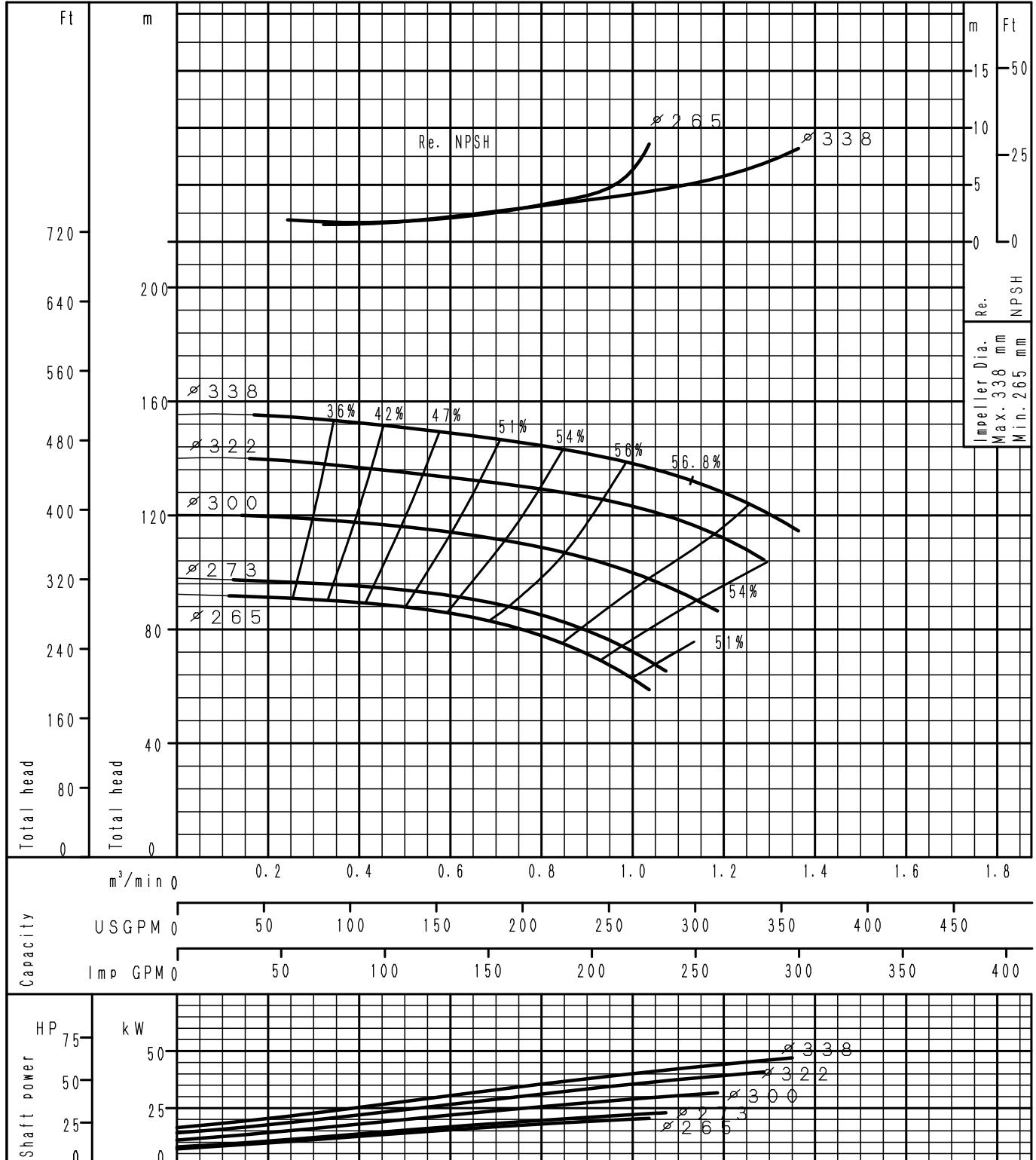

Performance Curve

2 Poles

GS50-125	According to ISO testing code 9906 Grade 3B
50Hz ( Speed 2900 min <sup>-1</sup> )	DENSITY= 1.0 kg/t , VISCOSITY= 1.0 mPa·s

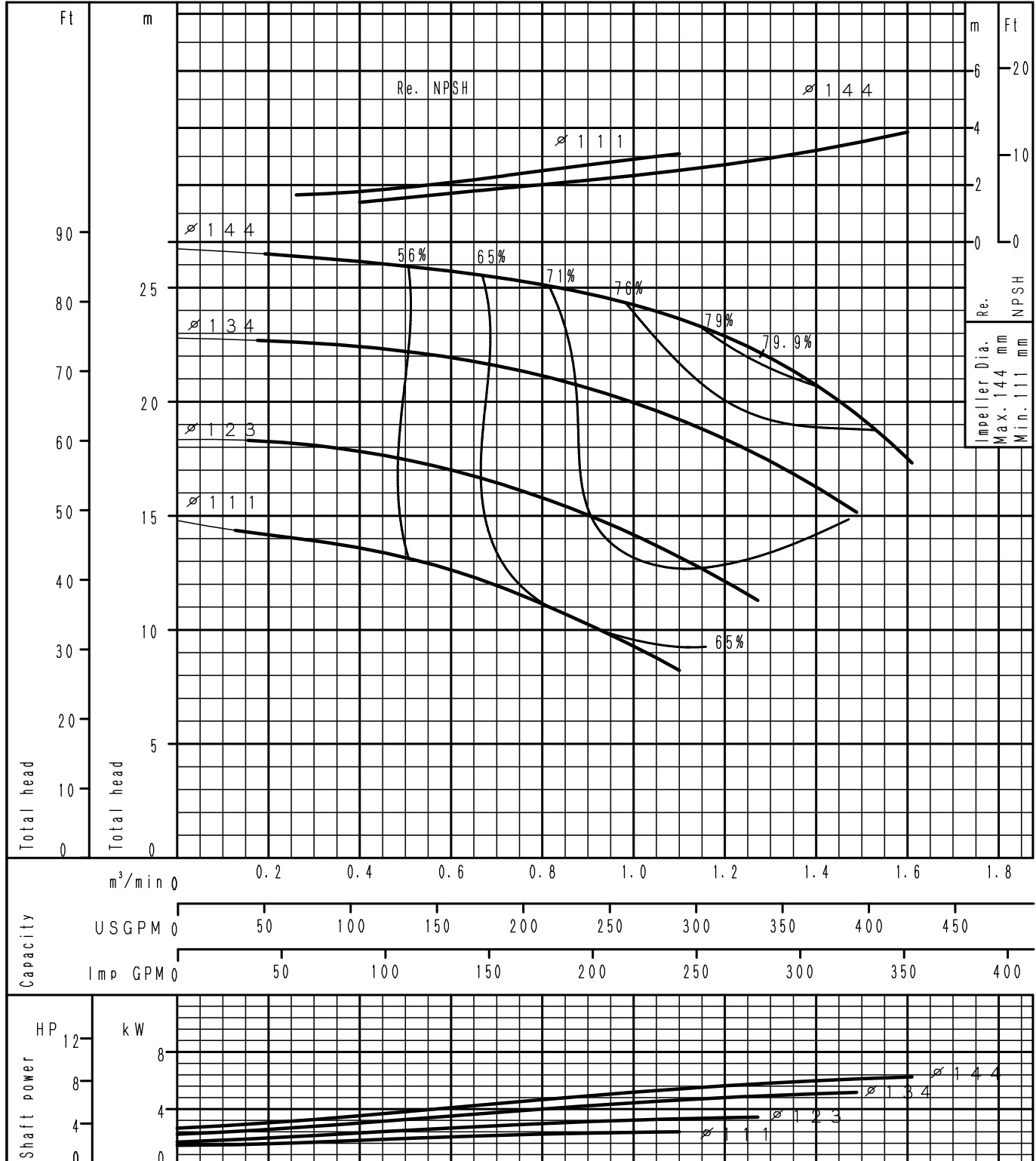

Performance Curve

2 Poles

GS50-160	According to ISO testing code 9906 Grade 3B
50Hz ( Speed 2900 min <sup>-1</sup> )	DENSITY= 1.0 kg/l , VISCOSITY= 1.0 mPa·s

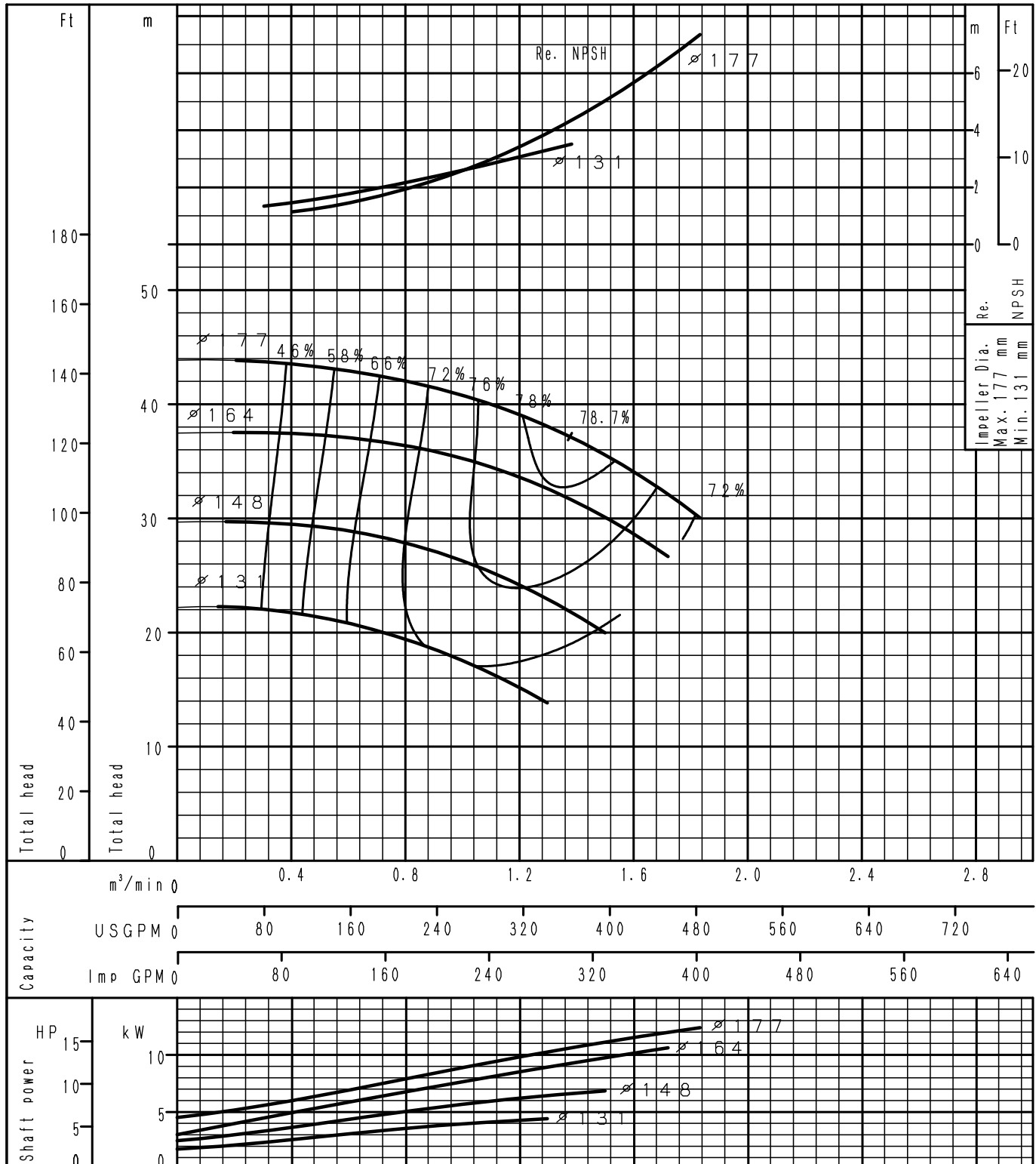

Performance Curve

2 Poles

GS50-200	According to ISO testing code 9906 Grade 3B
50Hz ( Speed 2900 min <sup>-1</sup> )	DENSITY= 1.0 kg/l , VISCOSITY= 1.0 mPa·s

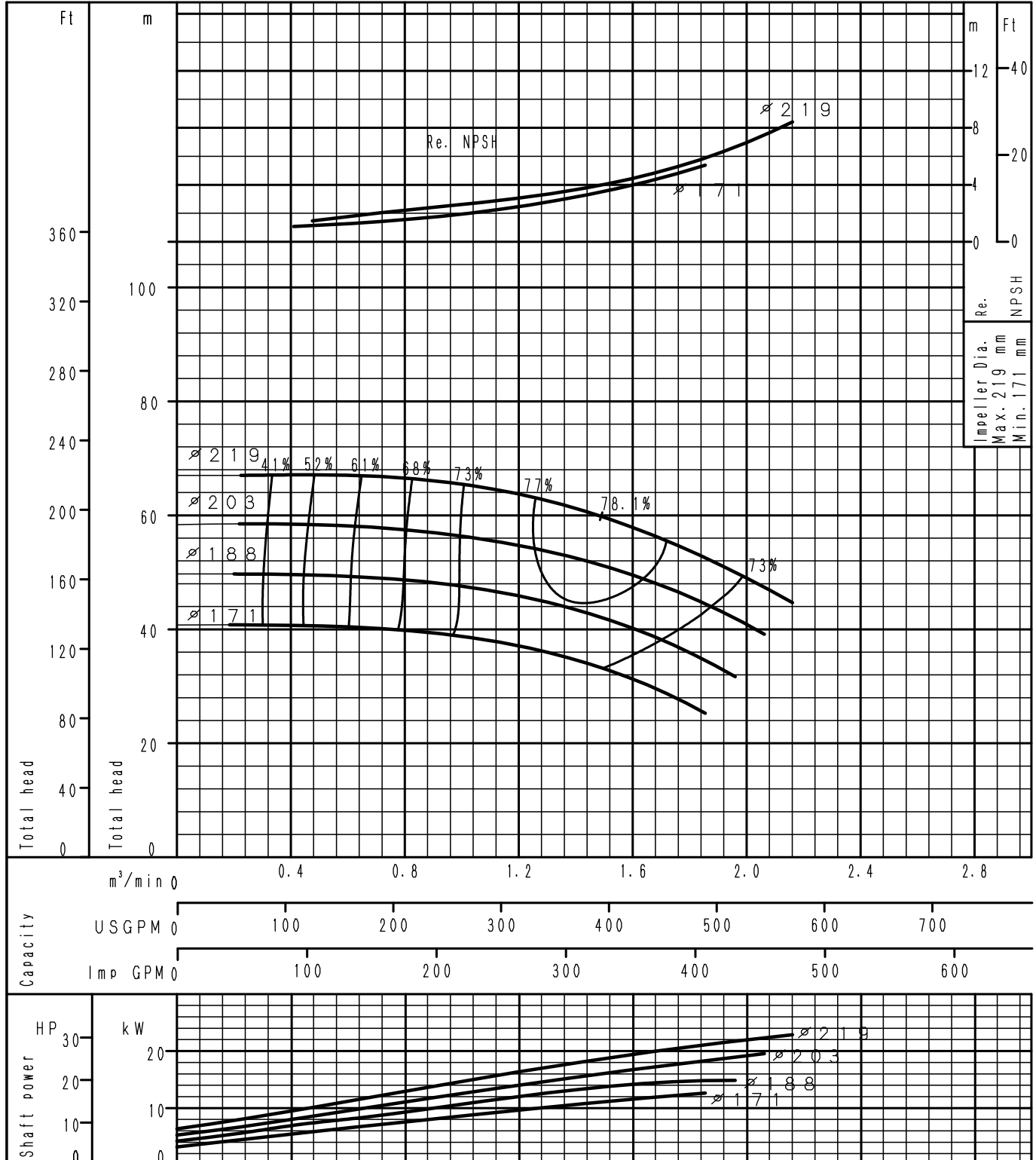

Performance Curve

2 Poles

GS50-250	According to ISO testing code 9906 Grade 3B
50Hz ( Speed 2900 min <sup>-1</sup> )	DENSITY= 1.0 kg/l , VISCOSITY= 1.0 mPa·s

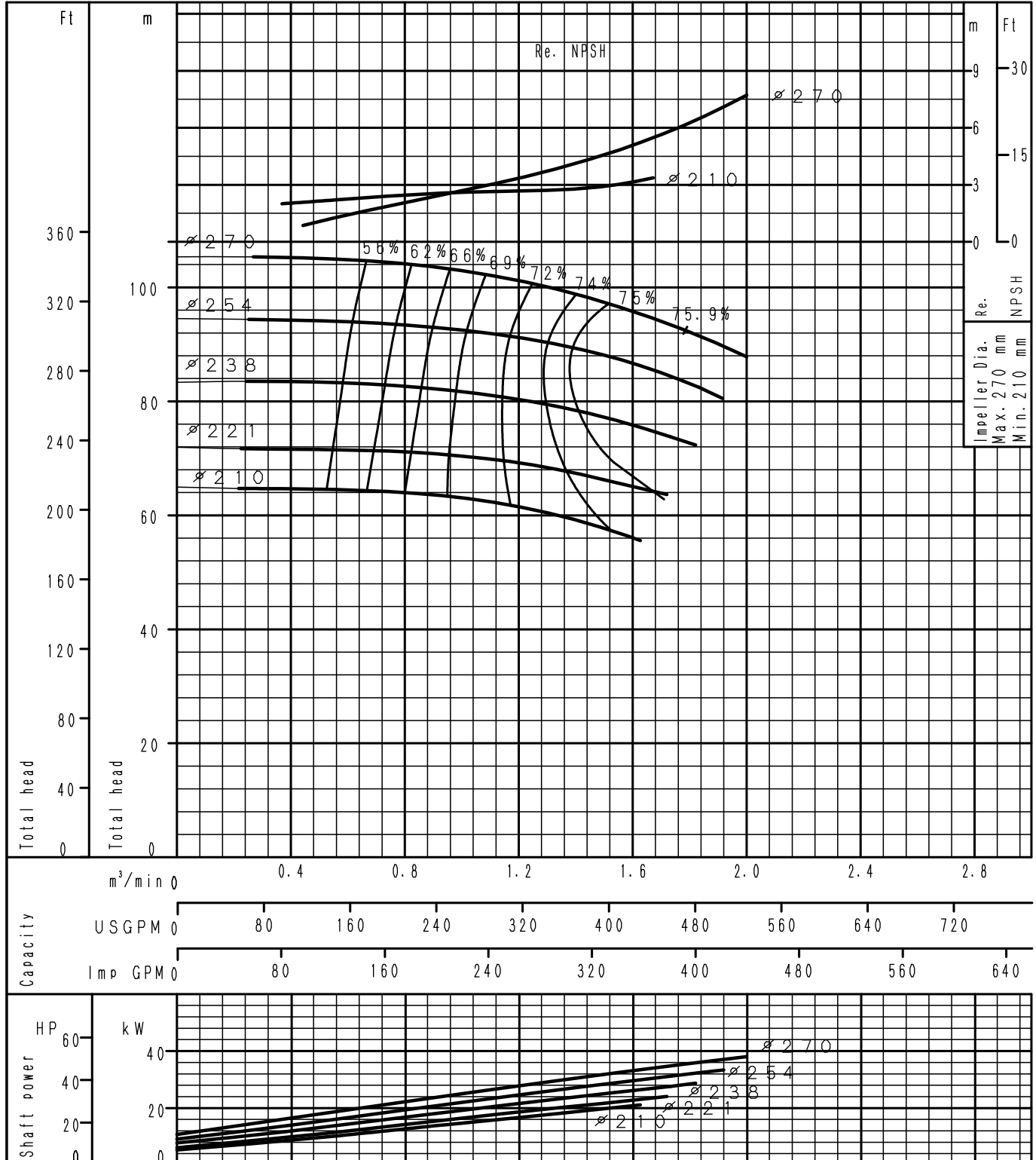

Performance Curve

2 Poles

GS50-315	According to ISO testing code 9906 Grade 3B
50Hz ( Speed 2900 min <sup>-1</sup> )	DENSITY= 1.0 kg/l , VISCOSITY= 1.0 mPa·s

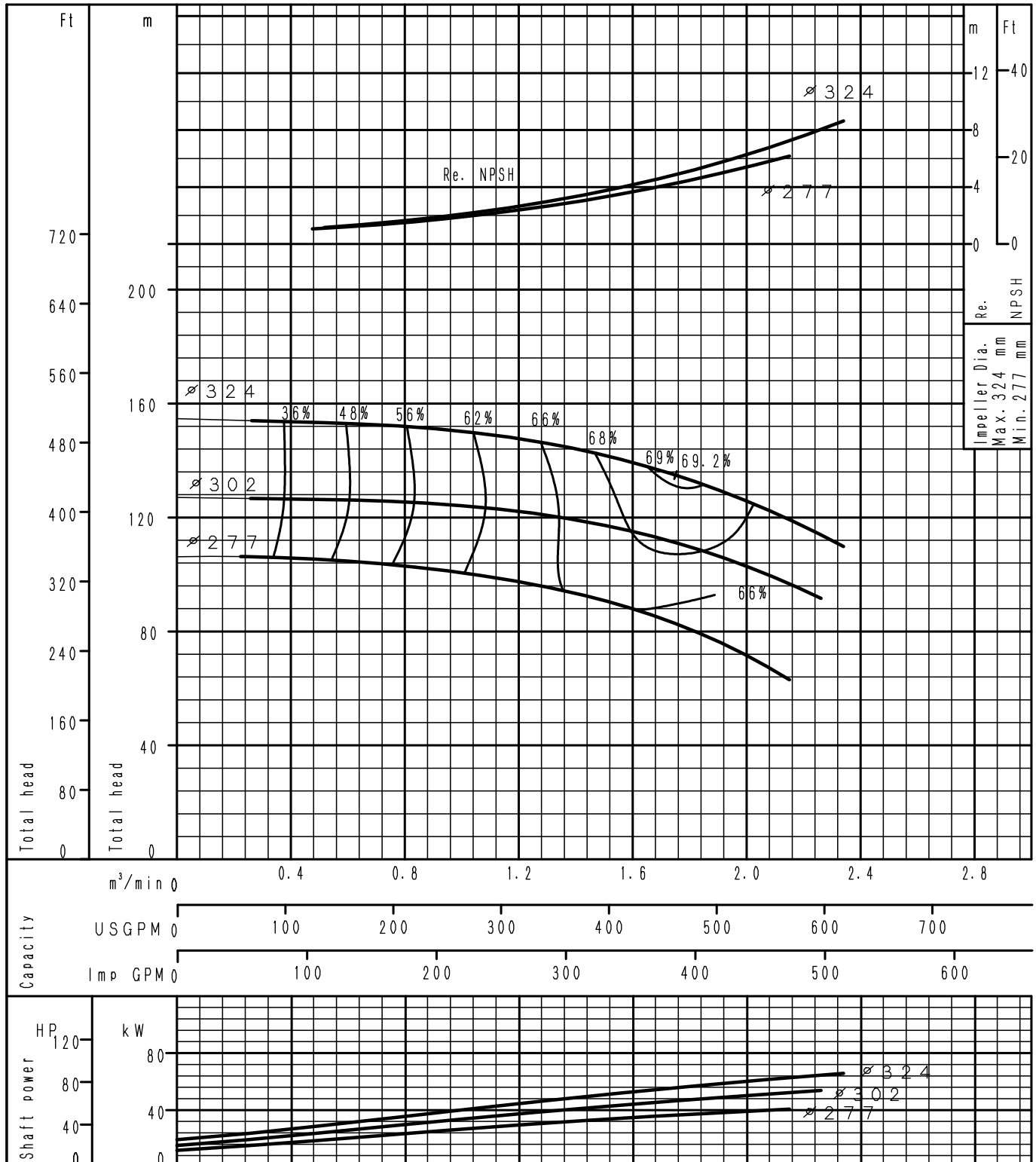

Performance Curve

2 Poles

<h1 style="font-size: 2em; margin: 0;">GS65-125</h1>	According to ISO testing code 9906 Grade 3B
50Hz ( Speed 2900 min <sup>-1</sup> )	DENSITY= 1.0 kg/l , VISCOSITY= 1.0 mPa·s

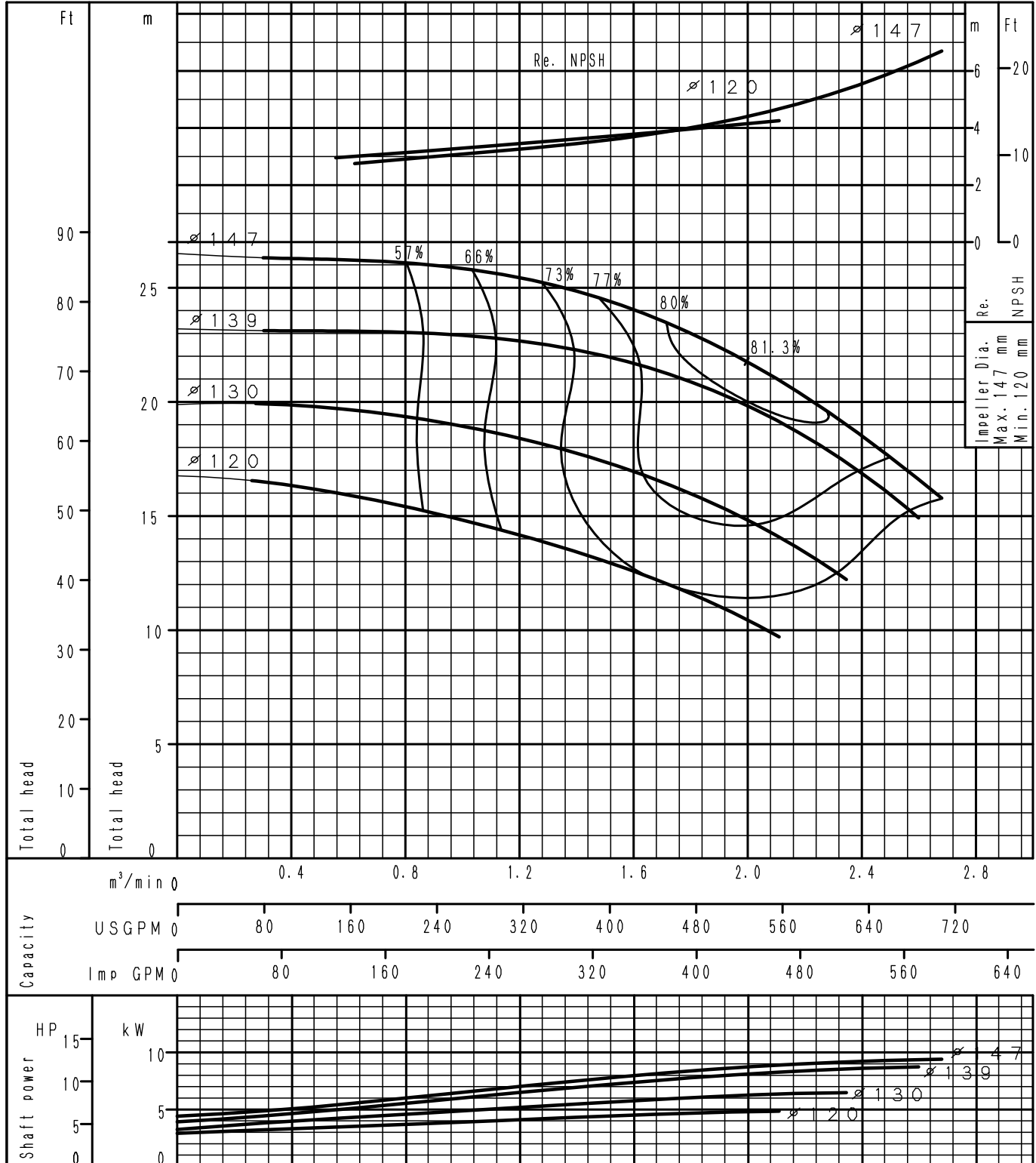

Performance Curve

2 Poles

GS65-160	According to ISO testing code 9906 Grade 3B
50Hz ( Speed 2900 min <sup>-1</sup> )	DENSITY= 1.0 kg/l , VISCOSITY= 1.0 mPa·s

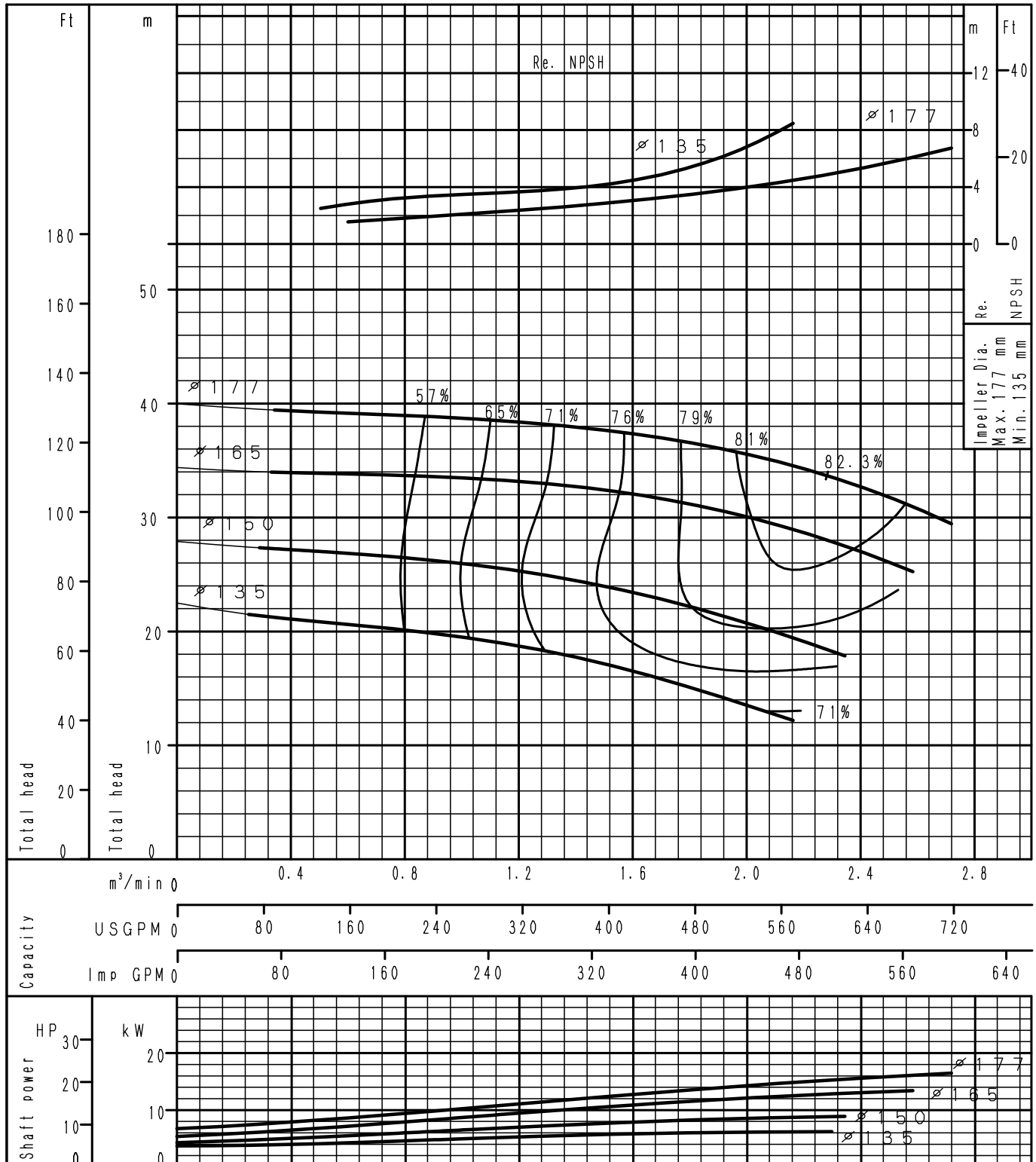



Performance Curve

2 Poles

GS65-200	According to ISO testing code 9906 Grade 3B
50Hz ( Speed 2900 min <sup>-1</sup> )	DENSITY= 1.0 kg/l , VISCOSITY= 1.0 mPa·s

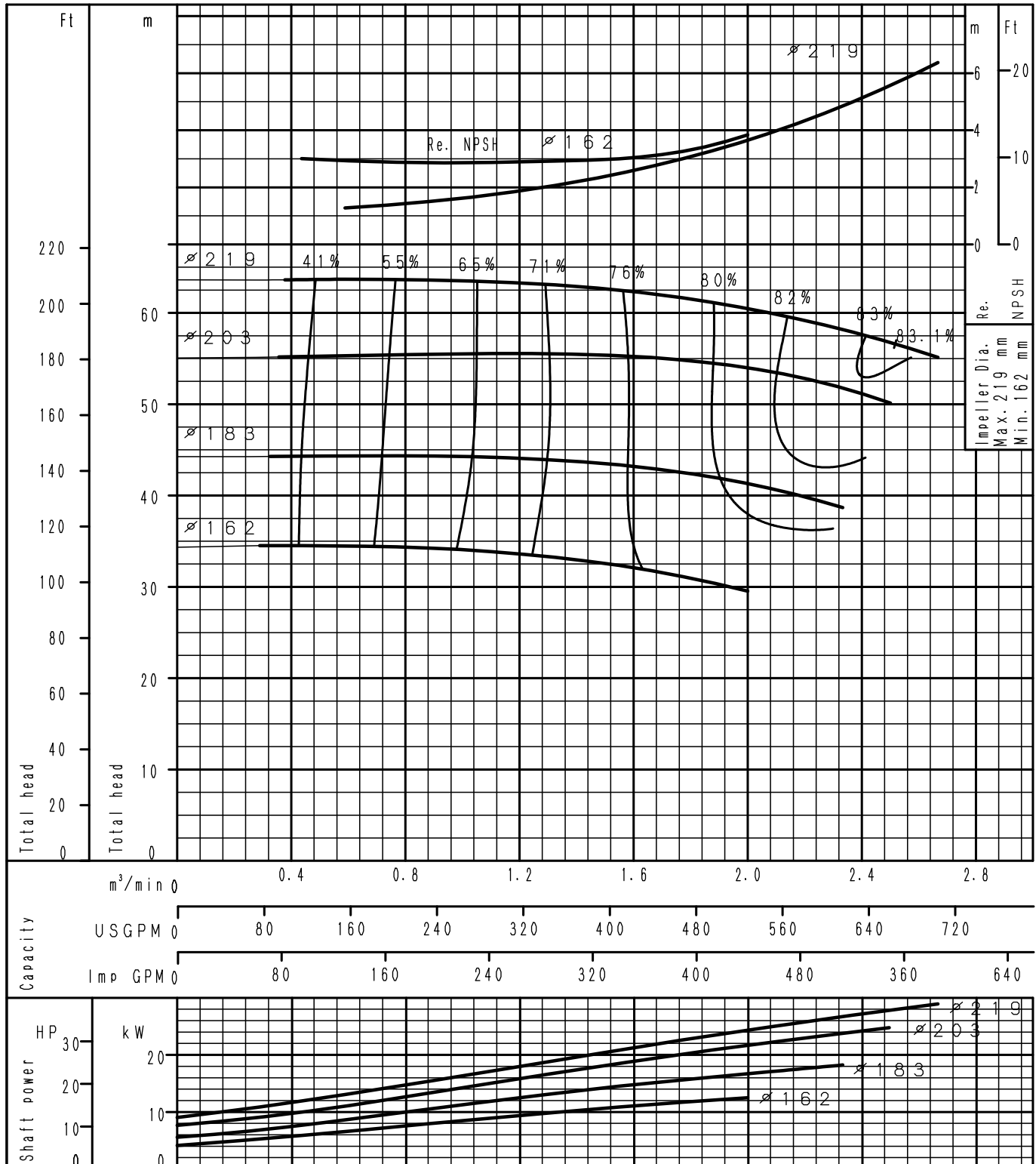

Performance Curve

2 Poles

GS65-250	According to ISO testing code 9906 Grade 3B
50Hz ( Speed 2900 min <sup>-1</sup> )	DENSITY= 1.0 kg/l , VISCOSITY= 1.0 mPa·s

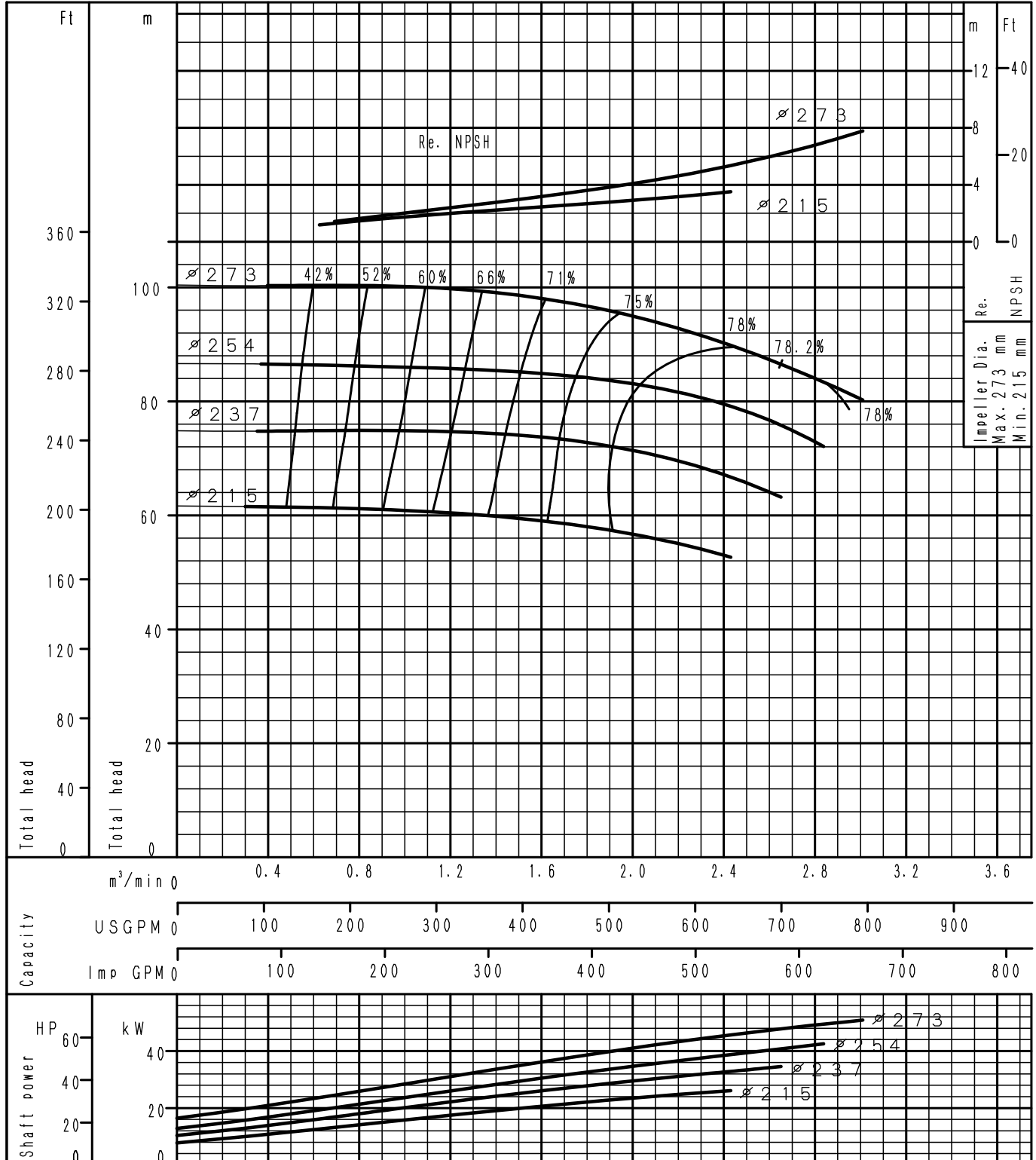

Performance Curve

2 Poles

<h1 style="margin: 0;">GS65-315</h1>	According to ISO testing code 9906 Grade 3B
50Hz ( Speed 2900 min <sup>-1</sup> )	DENSITY= 1.0 kg/l , VISCOSITY= 1.0 mPa·s

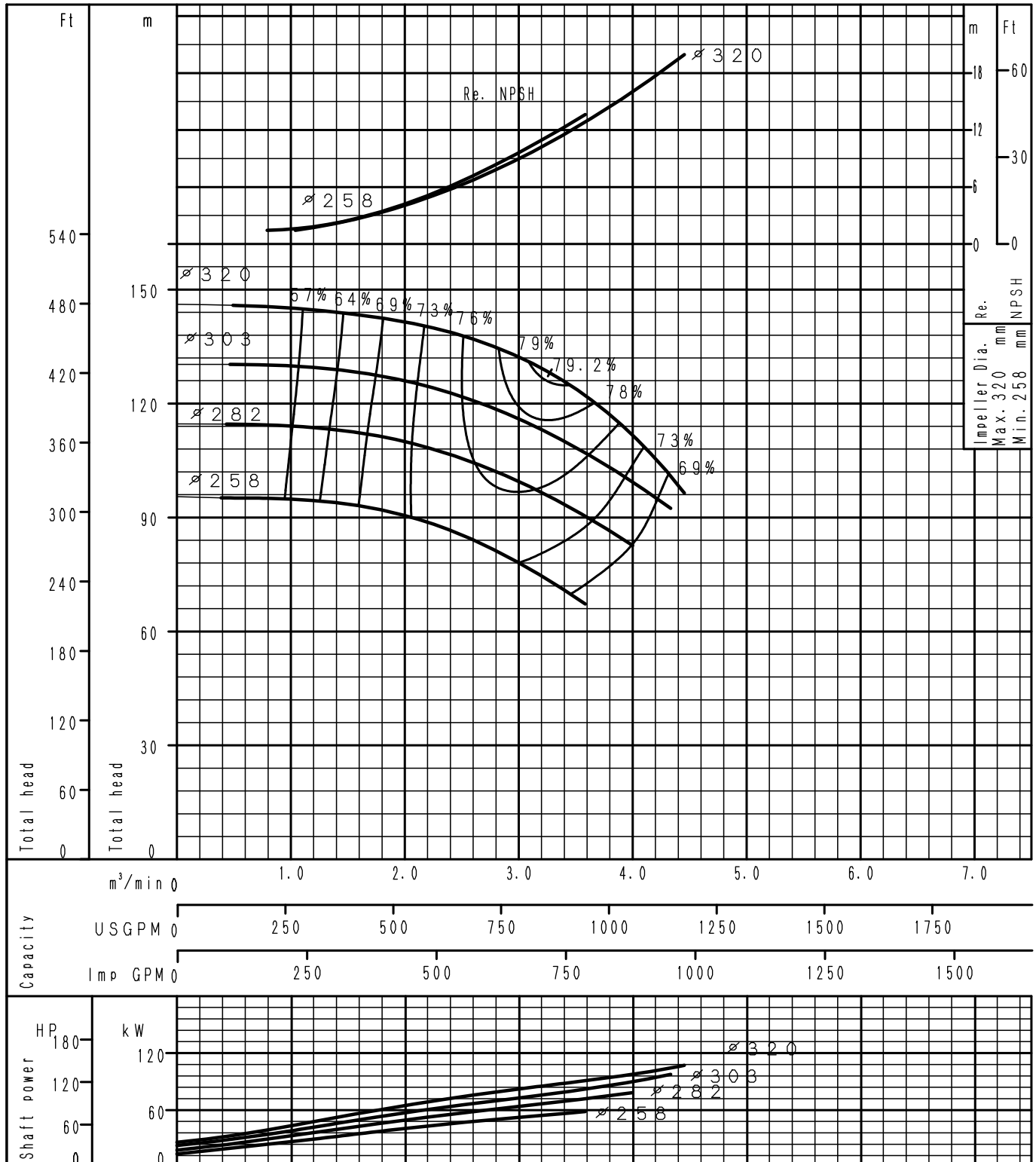

Performance Curve

2 Poles

<h1 style="margin: 0;">GS80-160</h1>	According to ISO testing code 9906 Grade 3B
50Hz ( Speed 2900 min <sup>-1</sup> )	DENSITY= 1.0 kg/t , VISCOSITY= 1.0 mPa·s

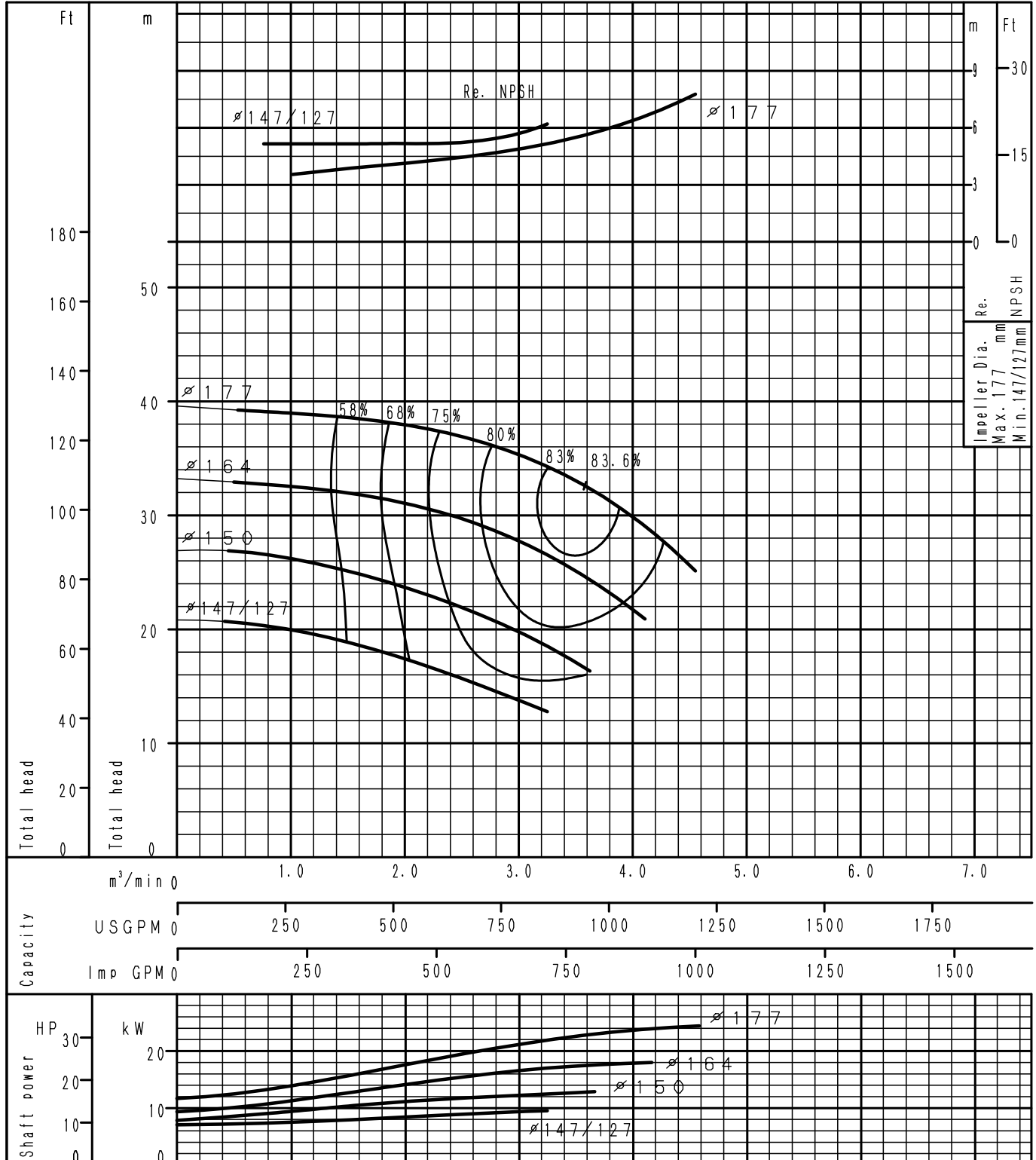

Performance Curve

2 Poles

GS80-200	According to ISO testing code 9906 Grade 3B
50Hz ( Speed 2900 min <sup>-1</sup> )	DENSITY= 1.0 kg/l , VISCOSITY= 1.0 mPa·s

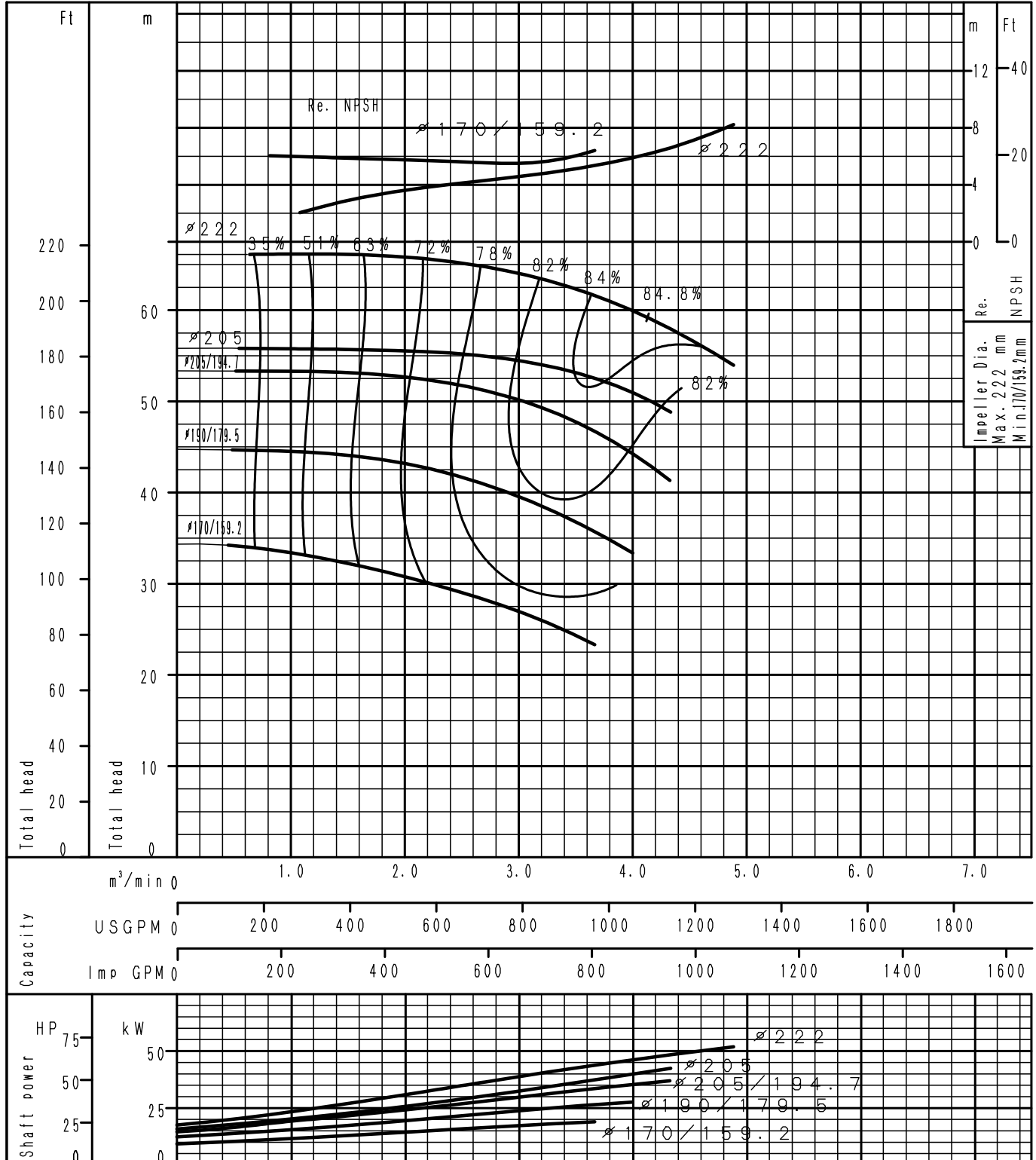

Performance Curve

2 Poles

GS80-250	According to ISO testing code 9906 Grade 3B
50Hz ( Speed 2900 min <sup>-1</sup> )	DENSITY= 1.0 kg/l , VISCOSITY= 1.0 mPa·s

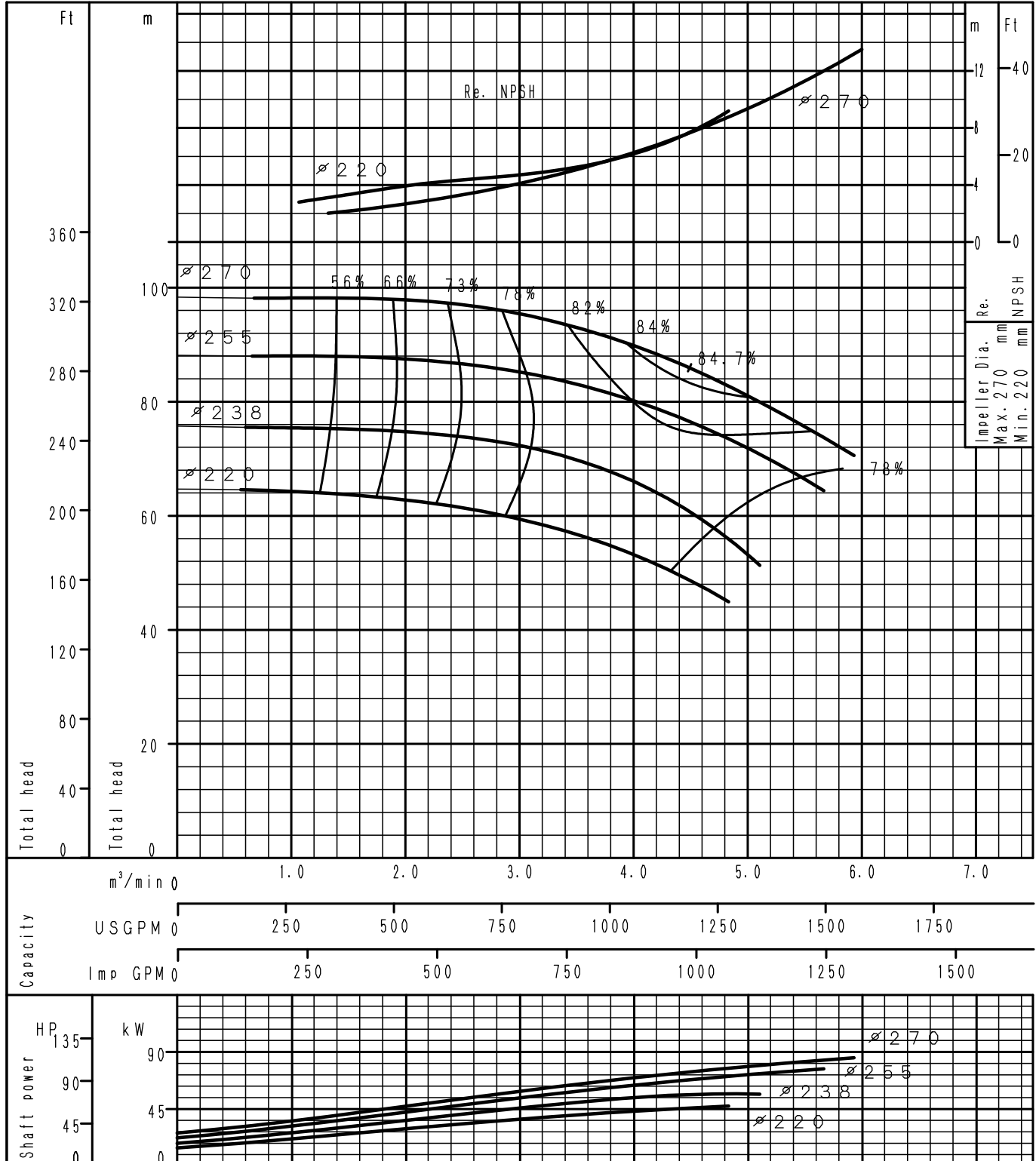

Performance Curve

2 Poles

GS80-315L	According to ISO testing code 9906 Grade 3B
50Hz ( Speed 2900 min <sup>-1</sup> )	DENSITY= 1.0 kg/l , VISCOSITY= 1.0 mPa·s

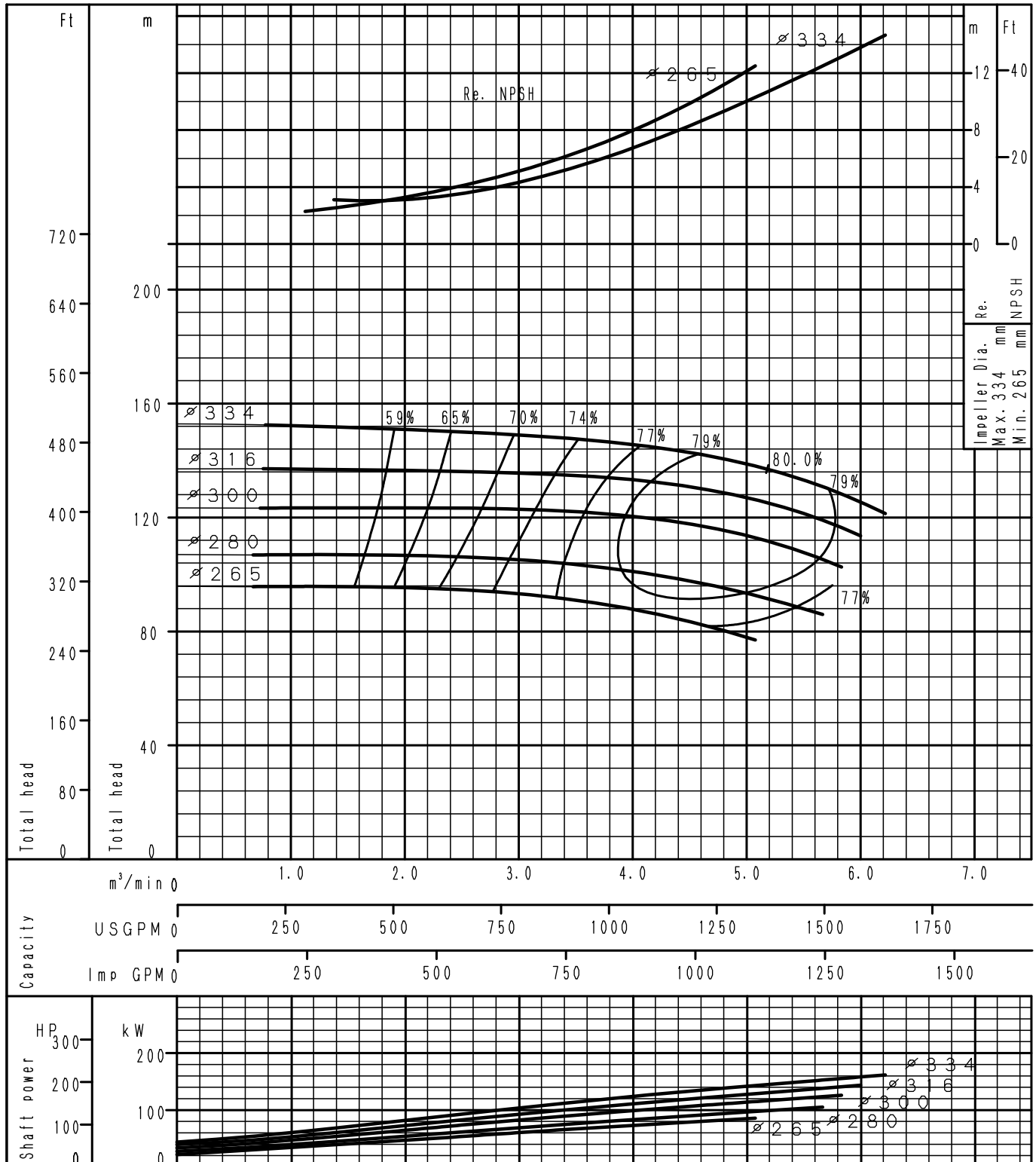

Performance Curve

2 Poles

GS100-160	According to ISO testing code 9906 Grade 3B
50Hz ( Speed 2900 min <sup>-1</sup> )	DENSITY= 1.0 kg/l , VISCOSITY= 1.0 mPa·s

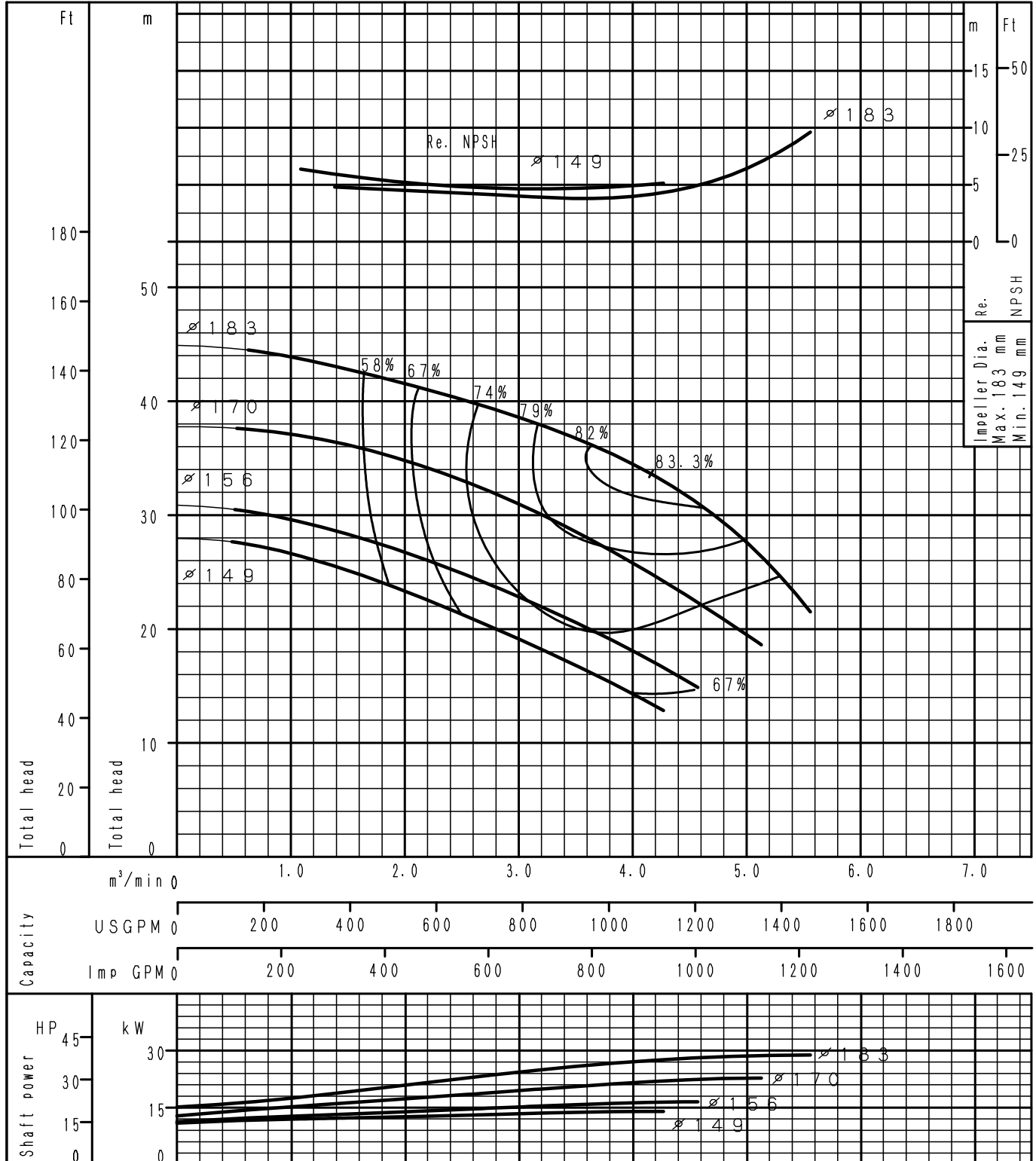



Performance Curve

2 Poles

GS100-200	According to ISO testing code 9906 Grade 3B
50Hz ( Speed 2900 min <sup>-1</sup> )	DENSITY= 1.0 kg/l , VISCOSITY= 1.0 mPa·s

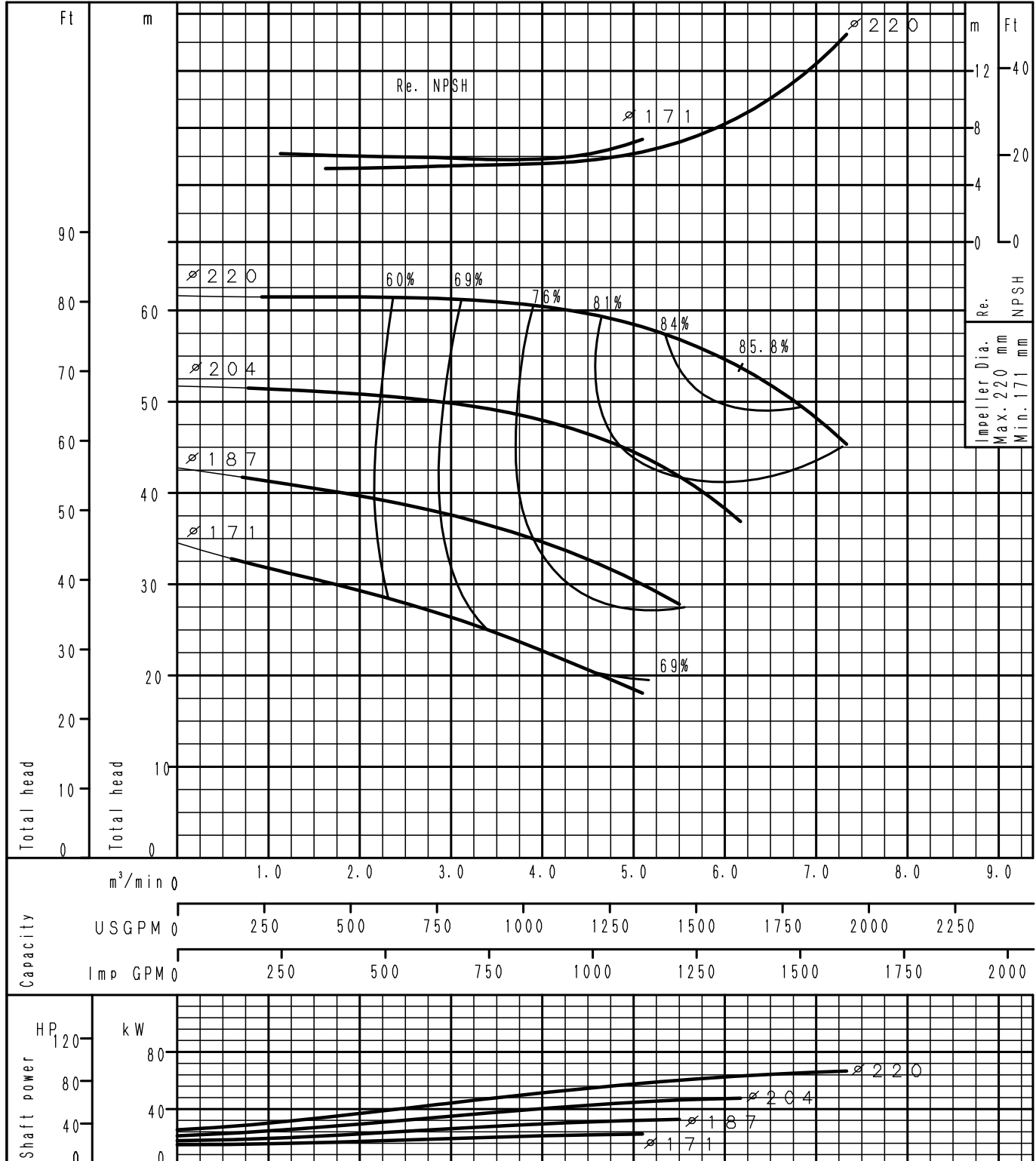

Performance Curve

2 Poles

GS100-250	According to ISO testing code 9906 Grade 3B
50Hz ( Speed 2900 min <sup>-1</sup> )	DENSITY= 1.0 kg/l , VISCOSITY= 1.0 mPa·s

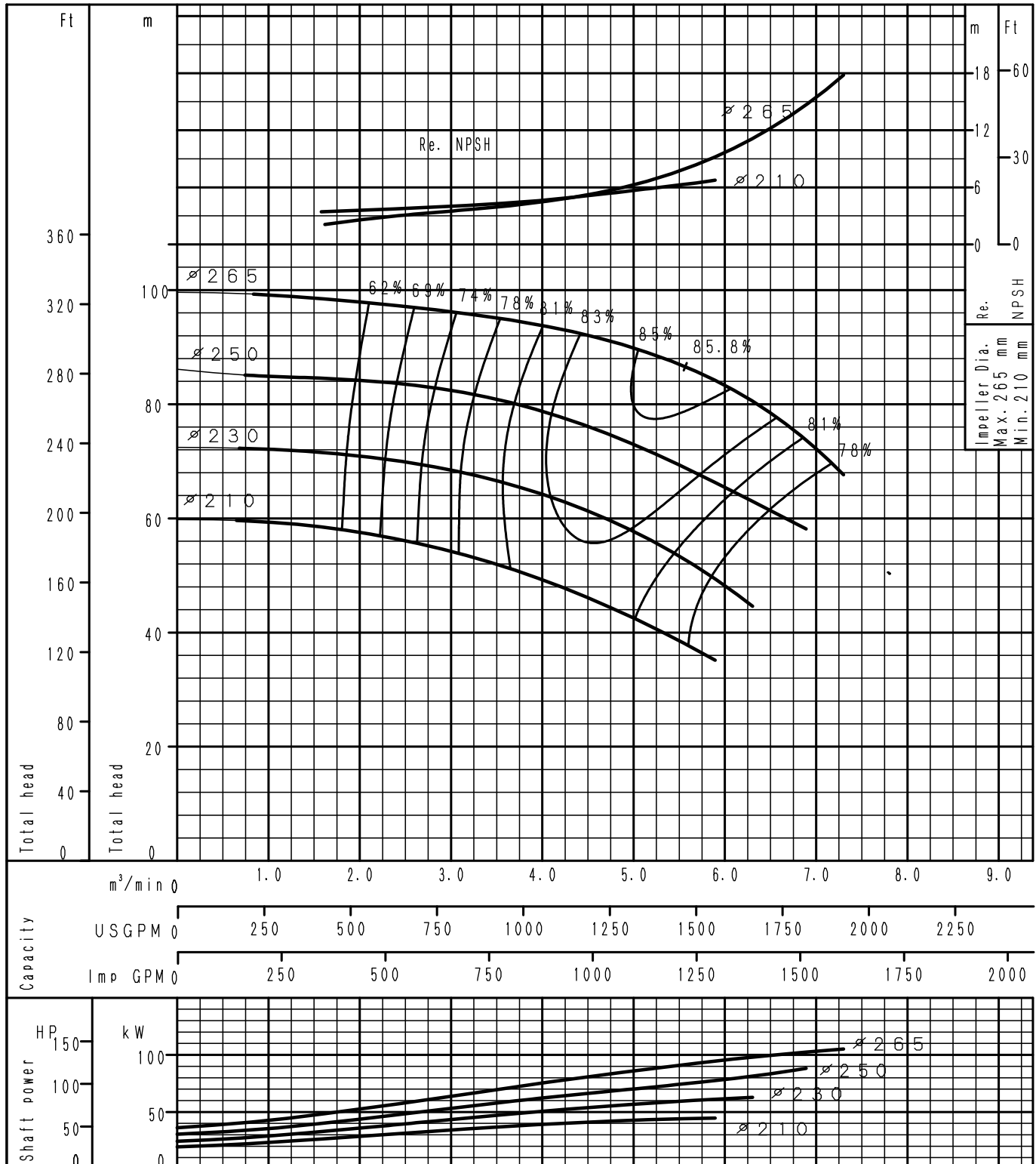

Performance Curve

2 Poles

GS100-315L	According to ISO testing code 9906 Grade 3B
50Hz ( Speed 2900 min <sup>-1</sup> )	DENSITY= 1.0 kg/l , VISCOSITY= 1.0 mPa·s

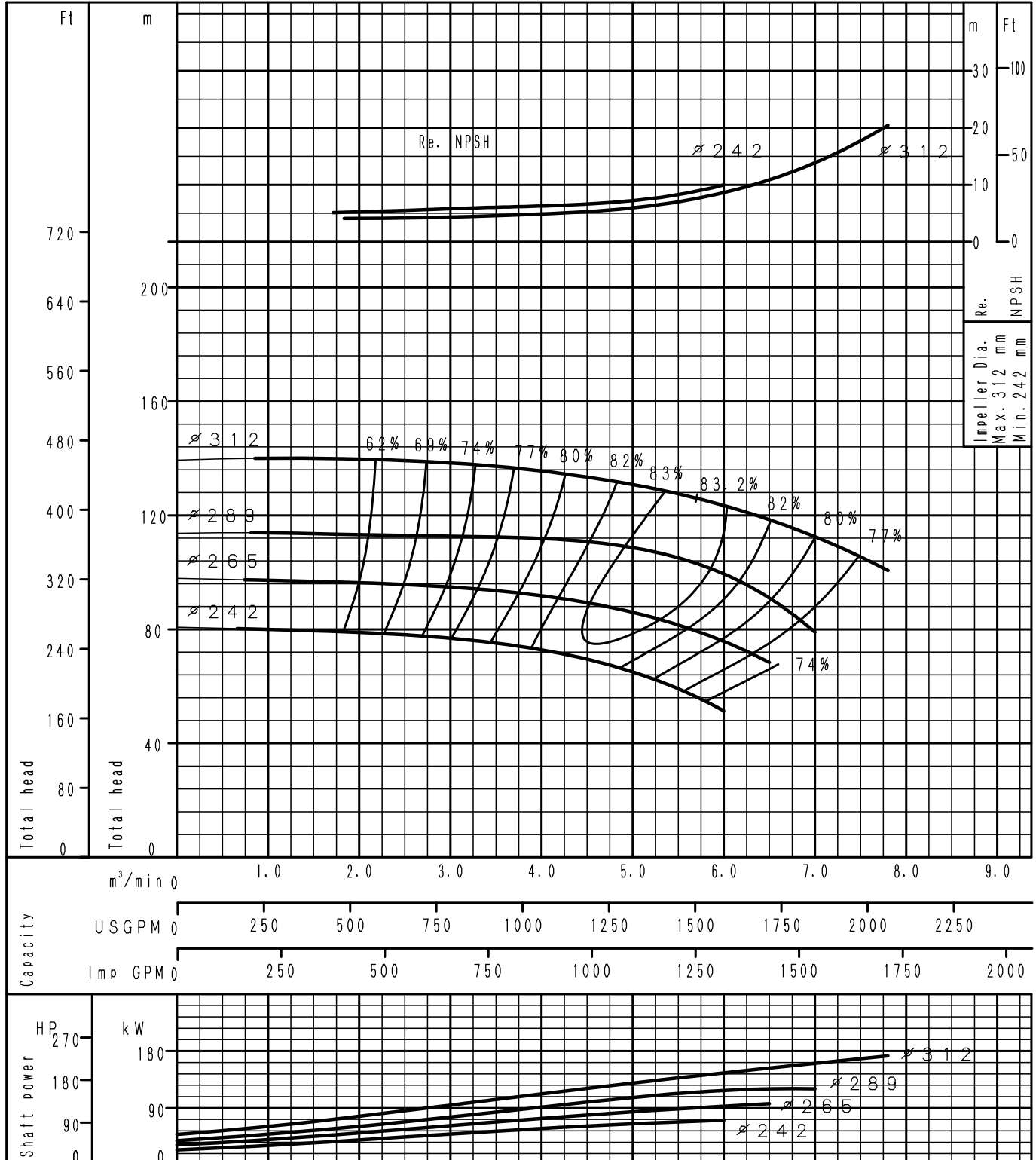

Performance Curve

2 Poles

GS125-200	According to ISO testing code 9906 Grade 3B
50Hz ( Speed 2900 min <sup>-1</sup> )	DENSITY= 1.0 kg/l , VISCOSITY= 1.0 mPa·s

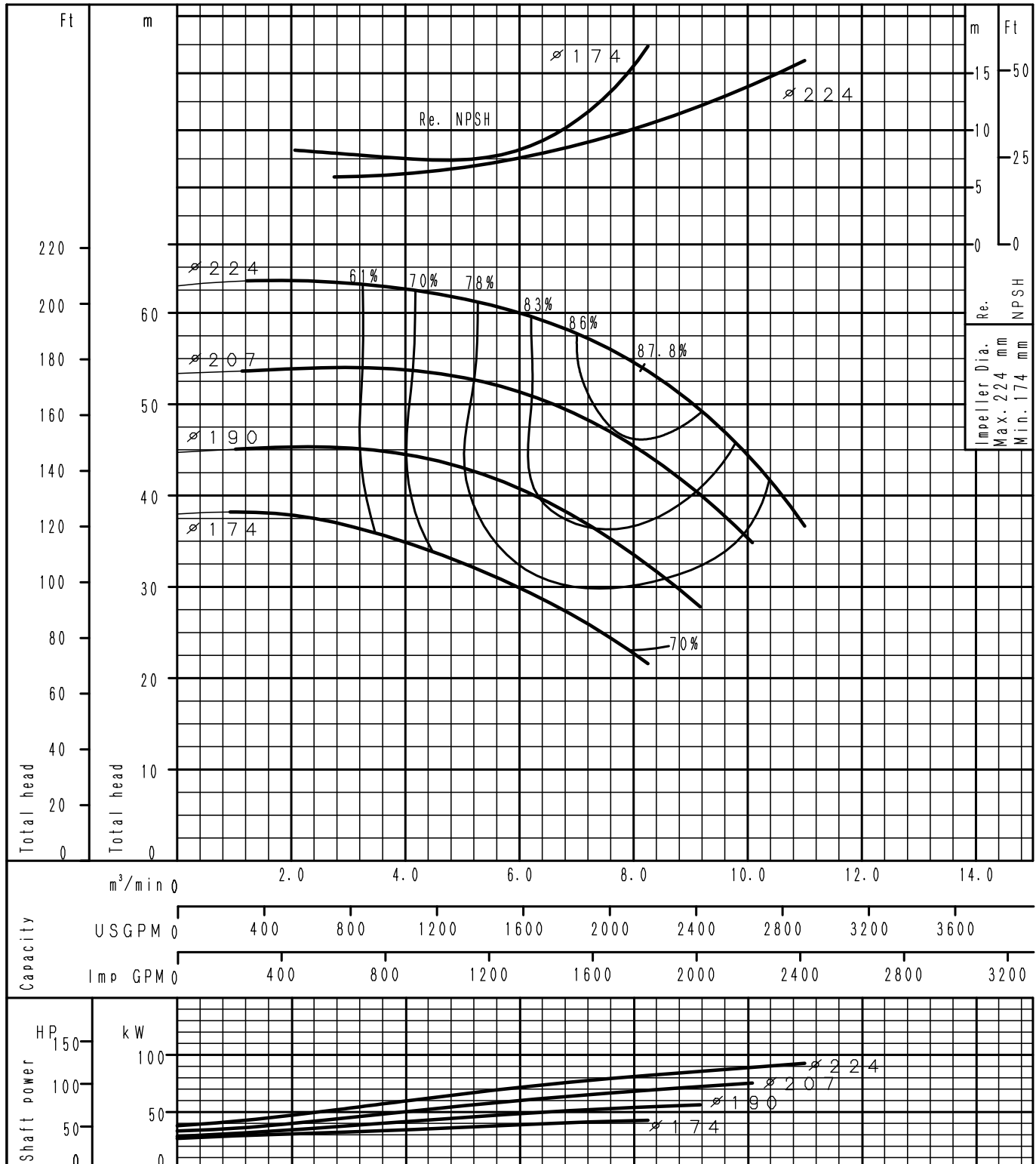

Performance Curve

2 Poles

GS125-250L	According to ISO testing code 9906 Grade 3B
50Hz ( Speed 2900 min <sup>-1</sup> )	DENSITY= 1.0 kg/l , VISCOSITY= 1.0 mPa·s

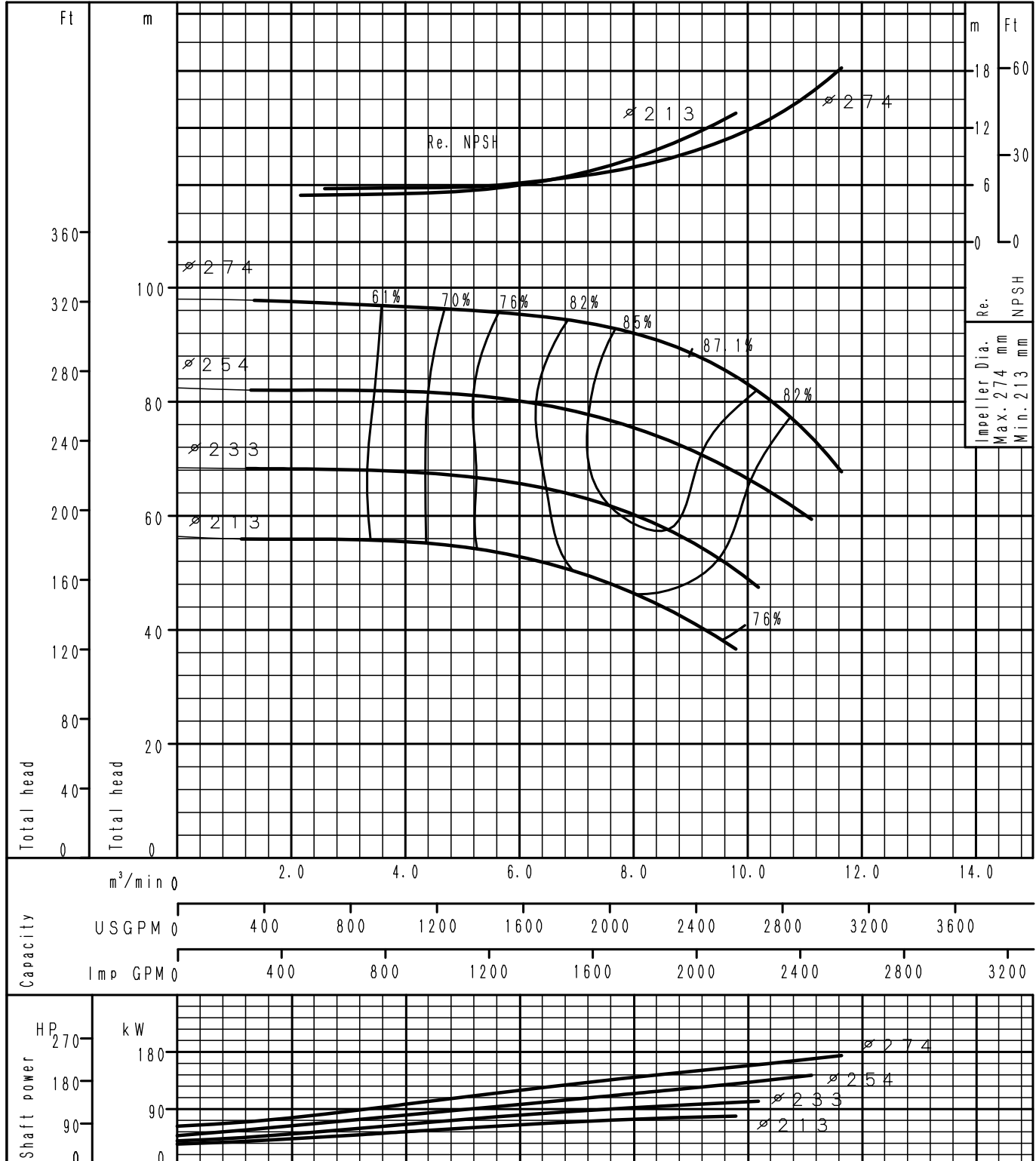

Performance Curve

2 Poles

GS125-315	According to ISO testing code 9906 Grade 3B
50Hz ( Speed 2900 min <sup>-1</sup> )	
DENSITY= 1.0 kg/l , VISCOSITY= 1.0 mPa·s	

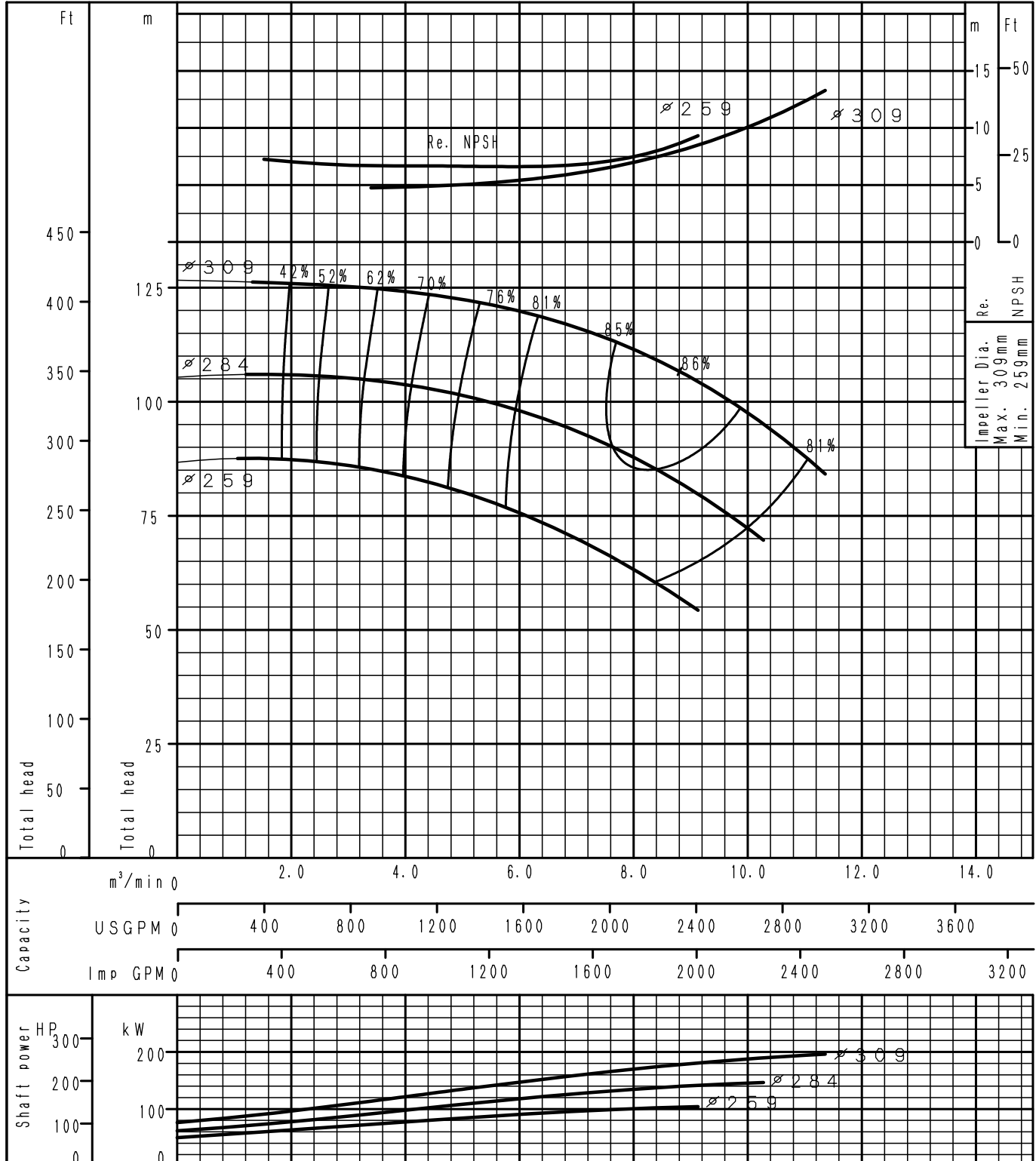

Performance Curve

2 Poles

GS150-200	According to ISO testing code 9906 Grade 3B
50Hz ( Speed 2900 min <sup>-1</sup> )	DENSITY= 1.0 kg/t , VISCOSITY= 1.0 mPa·s

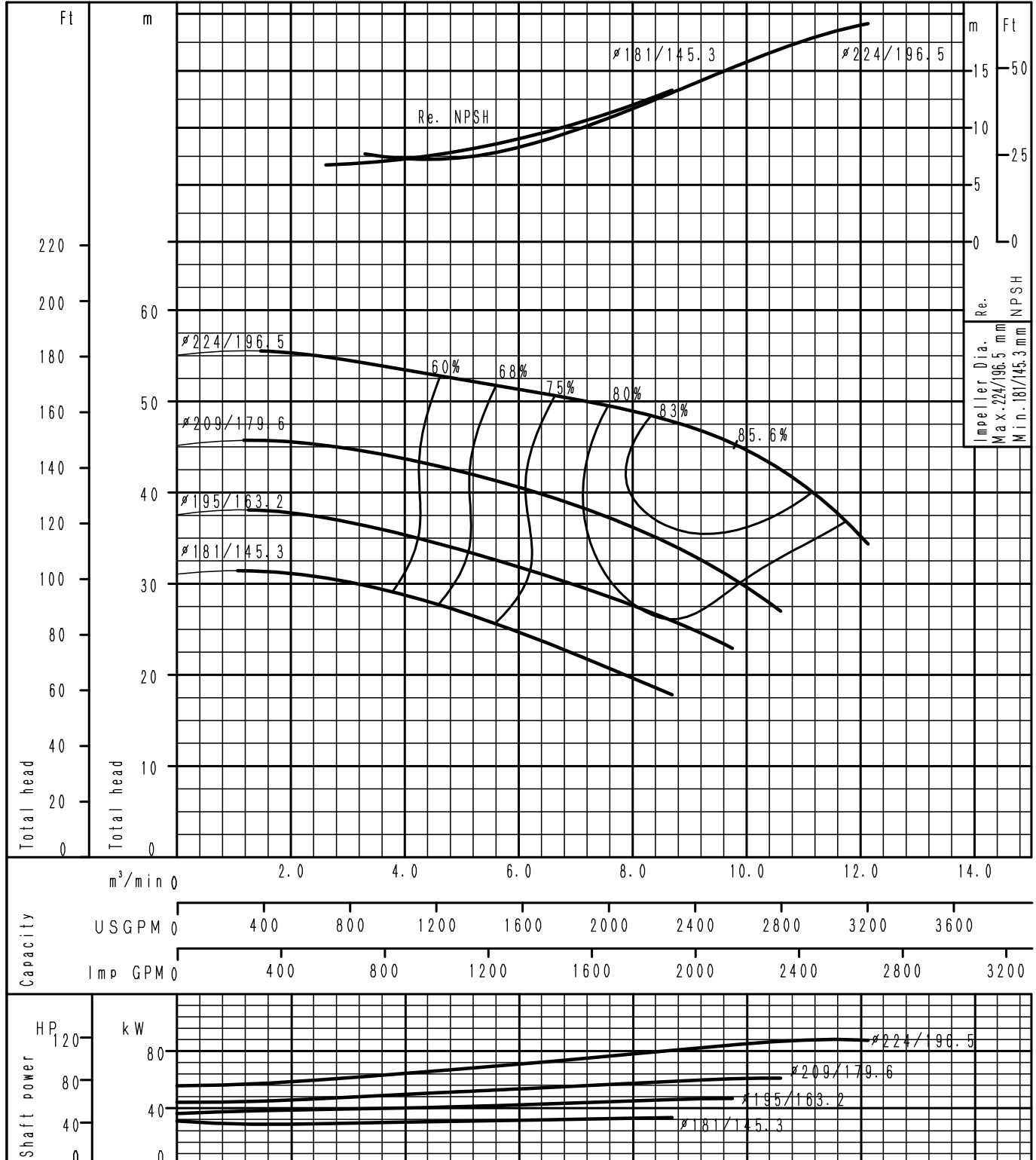

Performance Curve

2 Poles

<h1 style="margin: 0;">GS150-250</h1>	According to ISO testing code 9906 Grade 3B
50Hz ( Speed 2900 min <sup>-1</sup> )	DENSITY= 1.0 kg/l , VISCOSITY= 1.0 mPa·s

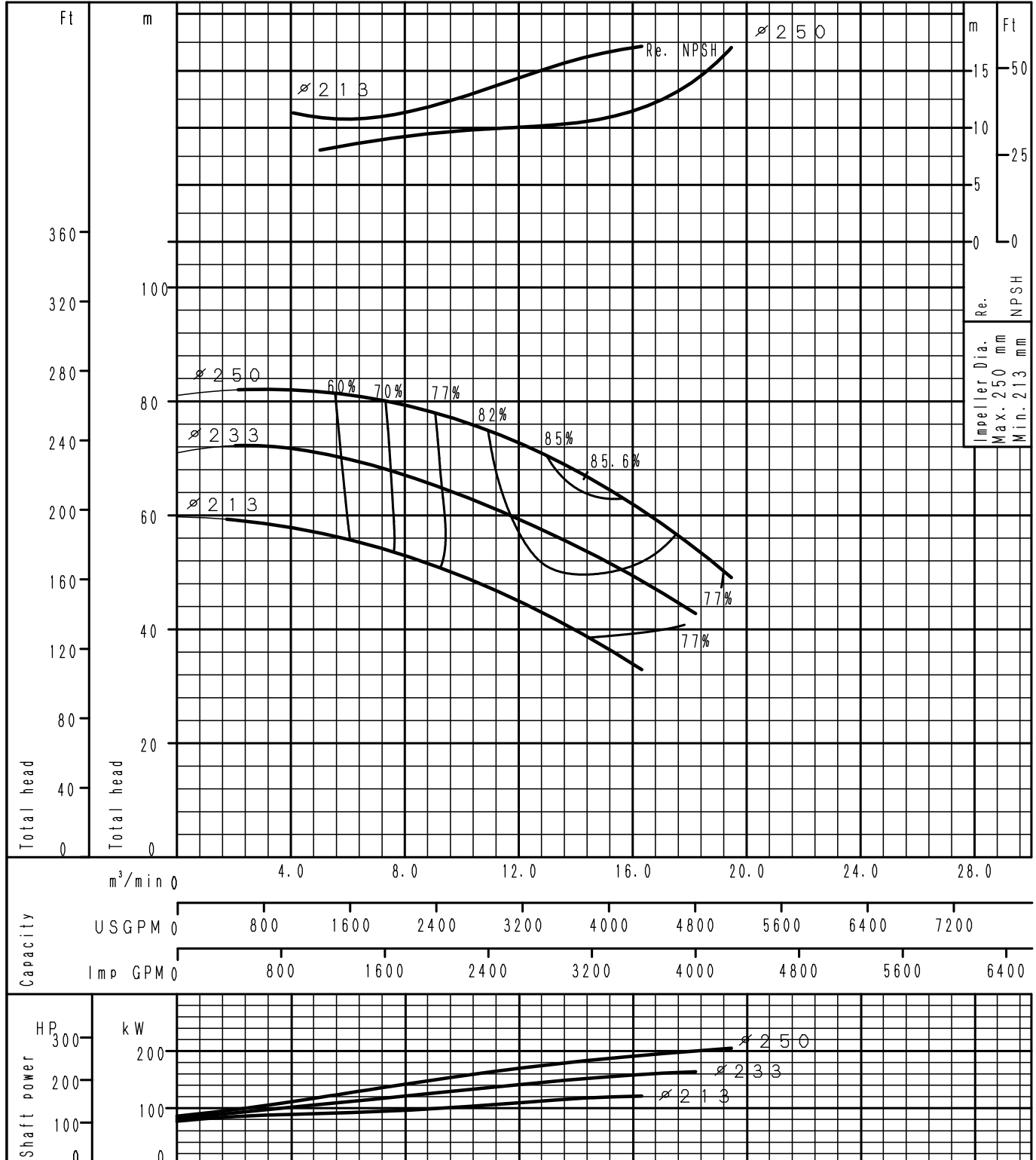



Performance Curve

4 Poles

GS32-125.1	According to ISO testing code 9906 Grade 3B
50Hz ( Speed 1450 min <sup>-1</sup> )	DENSITY= 1.0 kg/l , VISCOSITY= 1.0 mPa·s

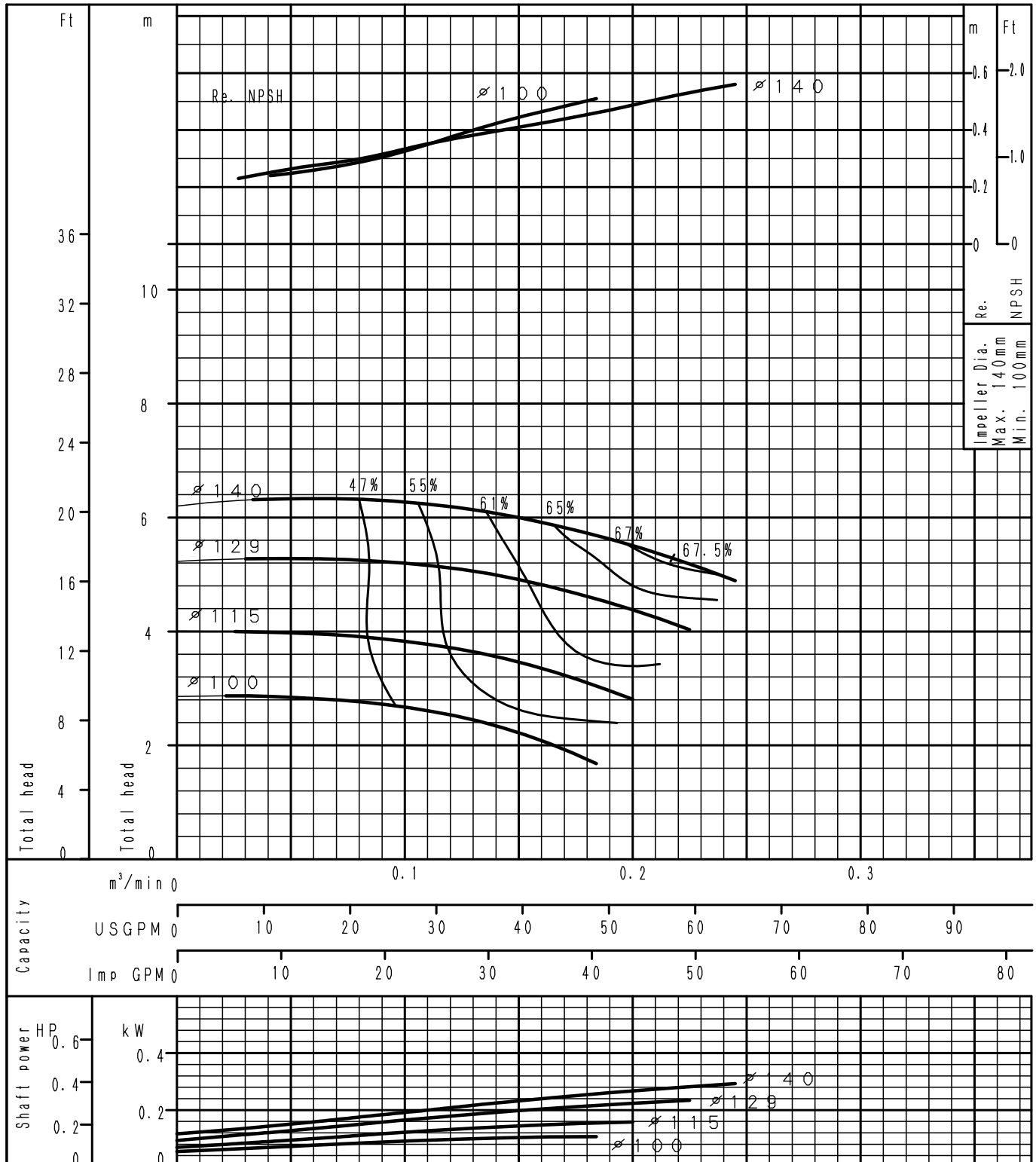

Performance Curve

4 Poles

GS32-160.1	According to ISO testing code 9906 Grade 3B
50Hz ( Speed 1450 min <sup>-1</sup> )	DENSITY= 1.0 kg/l , VISCOSITY= 1.0 mPa·s

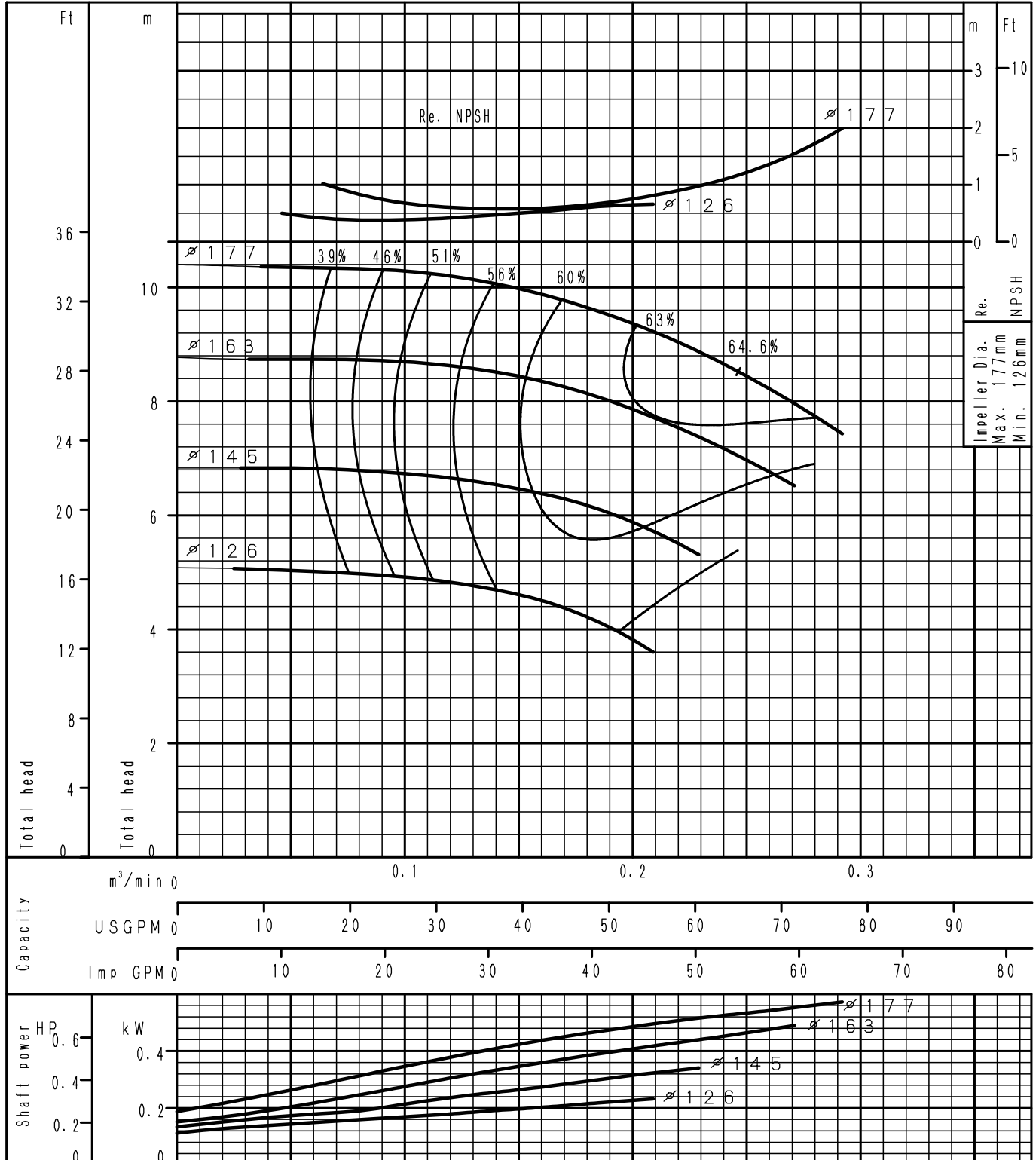

Performance Curve

4 Poles

GS32-200.1	According to ISO testing code 9906 Grade 3B
50Hz ( Speed 1450 min <sup>-1</sup> )	DENSITY= 1.0 kg/l , VISCOSITY= 1.0 mPa·s

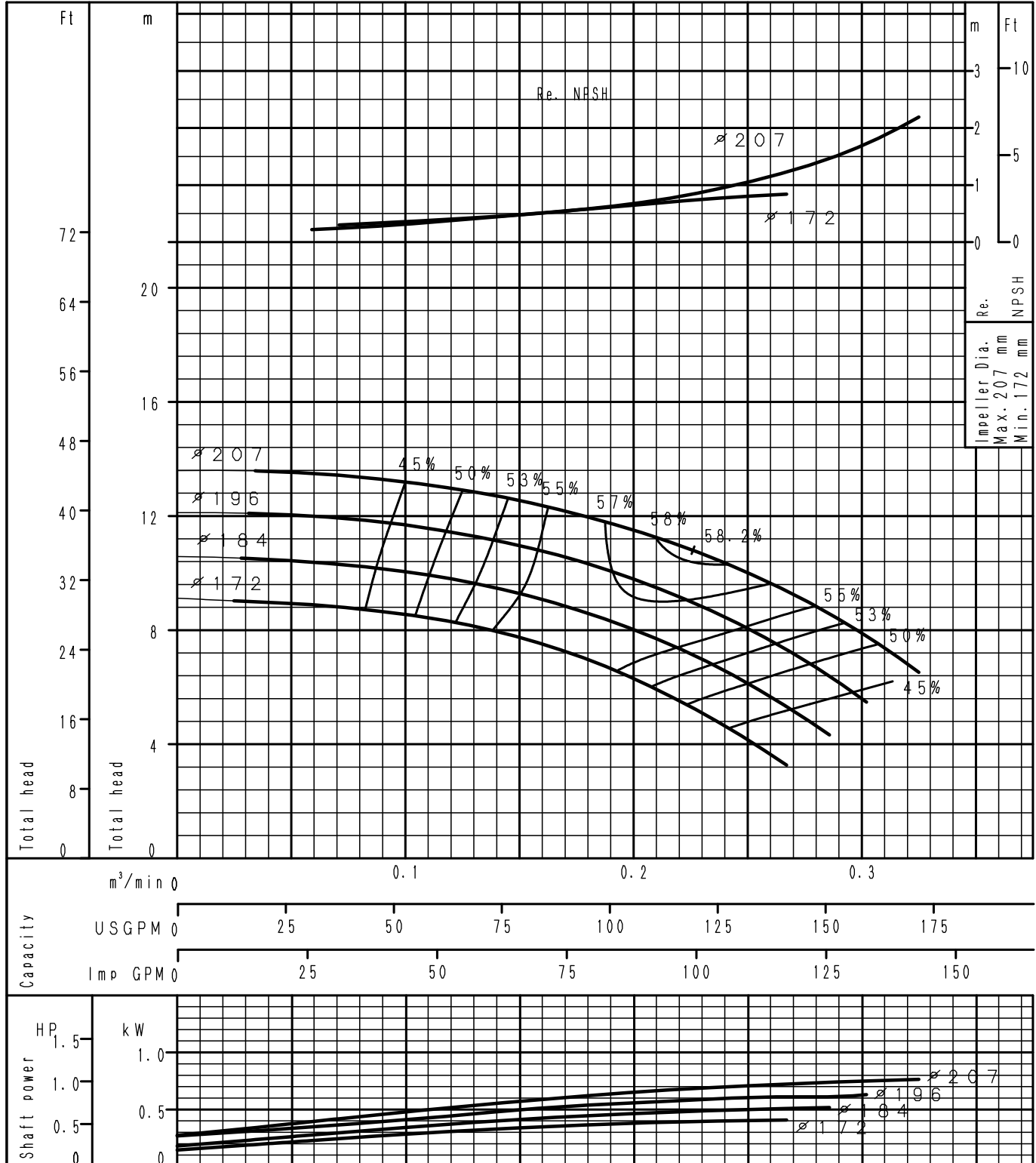

Performance Curve

4 Poles

GS32-125	According to ISO testing code 9906 Grade 3B
50Hz ( Speed 1450 min <sup>-1</sup> )	DENSITY= 1.0 kg/l , VISCOSITY= 1.0 mPa·s

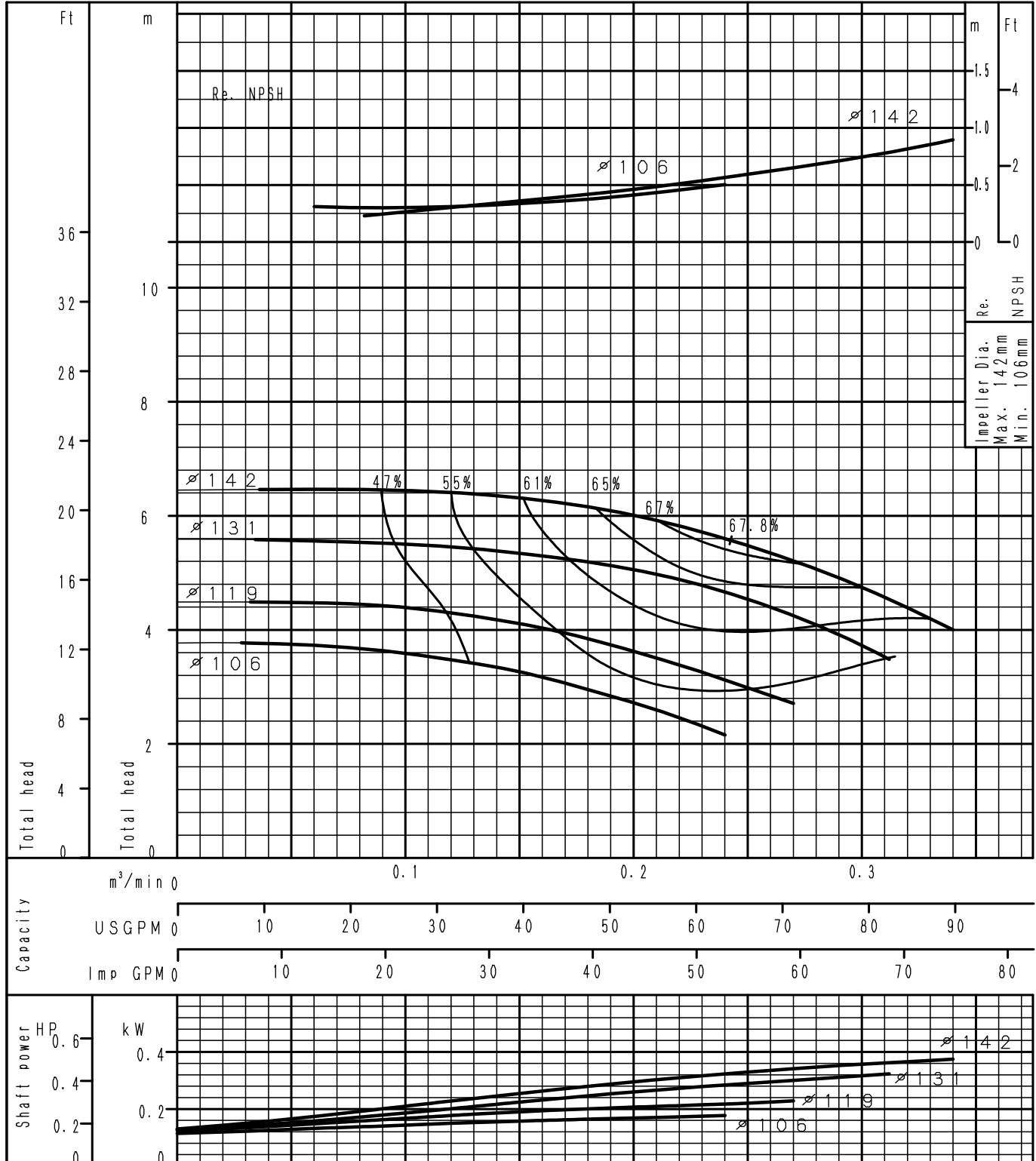

Performance Curve

4 Poles

GS32-160	According to ISO testing code 9906 Grade 3B
50Hz ( Speed 1450 min <sup>-1</sup> )	DENSITY= 1.0 kg/l , VISCOSITY= 1.0 mPa·s

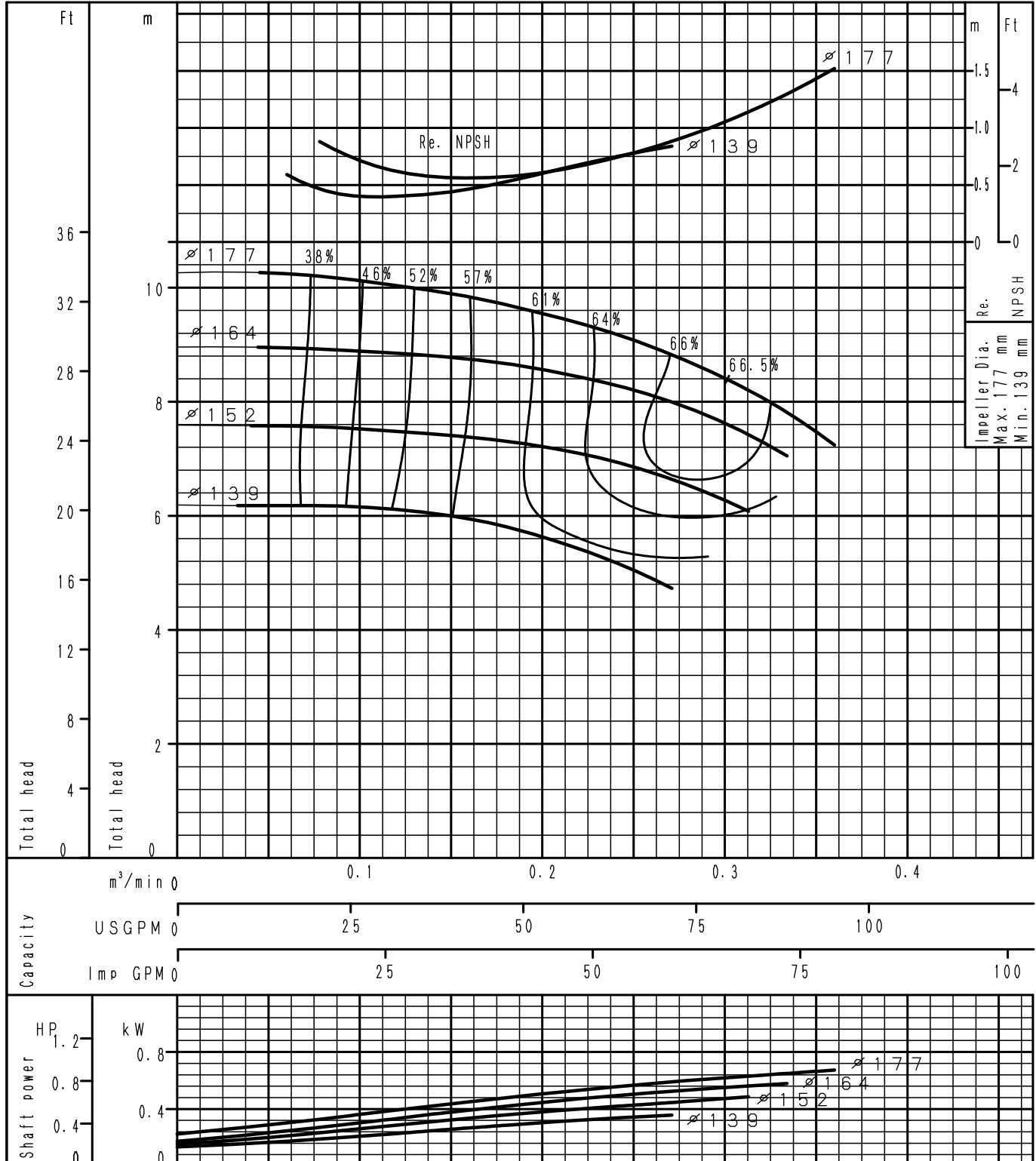

Performance Curve

4 Poles

GS32-200	According to ISO testing code 9906 Grade 3B
50Hz ( Speed 1450 min <sup>-1</sup> )	DENSITY= 1.0 kg/l , VISCOSITY= 1.0 mPa·s

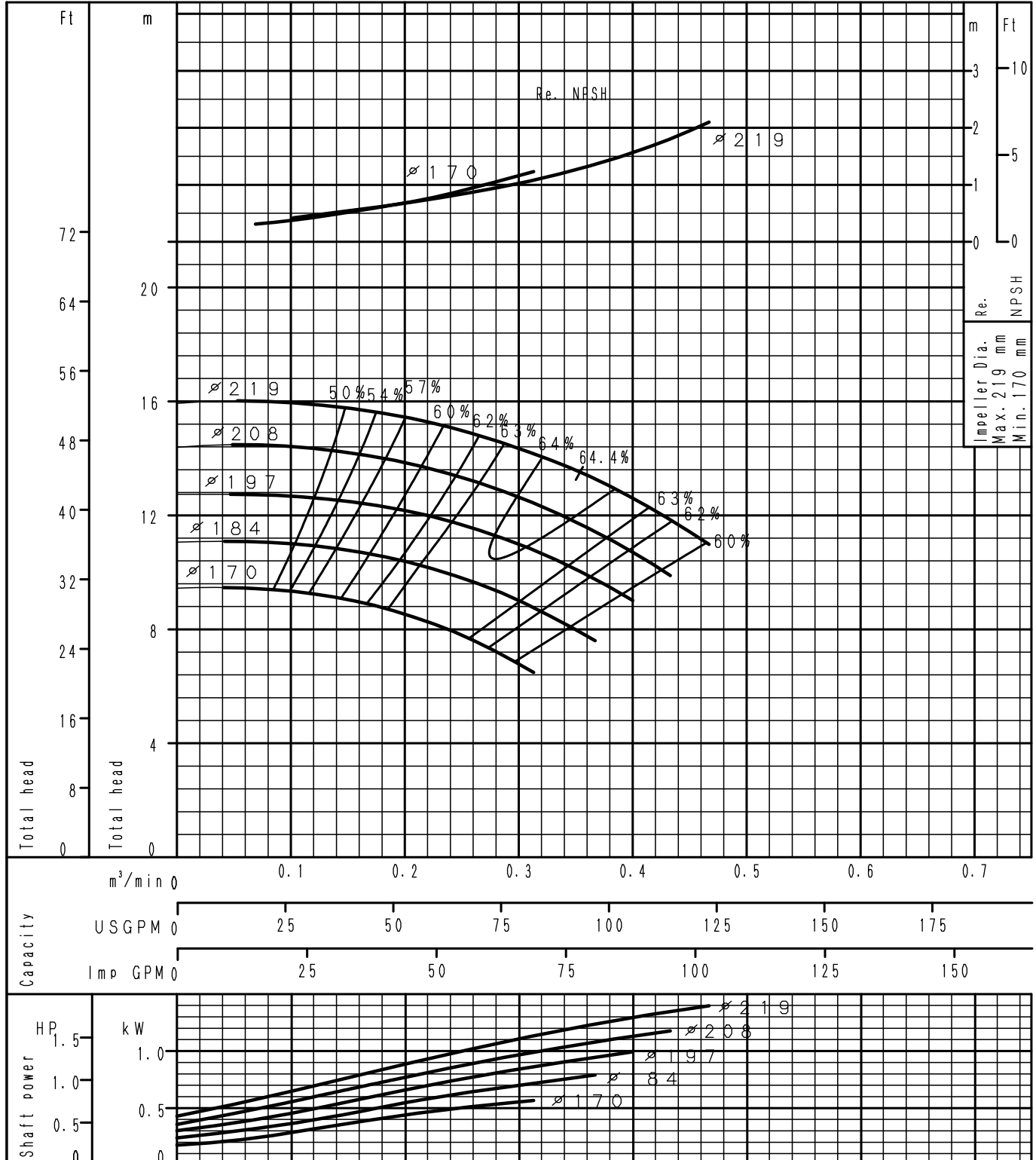

Performance Curve

4 Poles

GS32-250	According to ISO testing code 9906 Grade 3B
50Hz ( Speed 1450 min <sup>-1</sup> )	DENSITY= 1.0 kg/l , VISCOSITY= 1.0 mPa·s

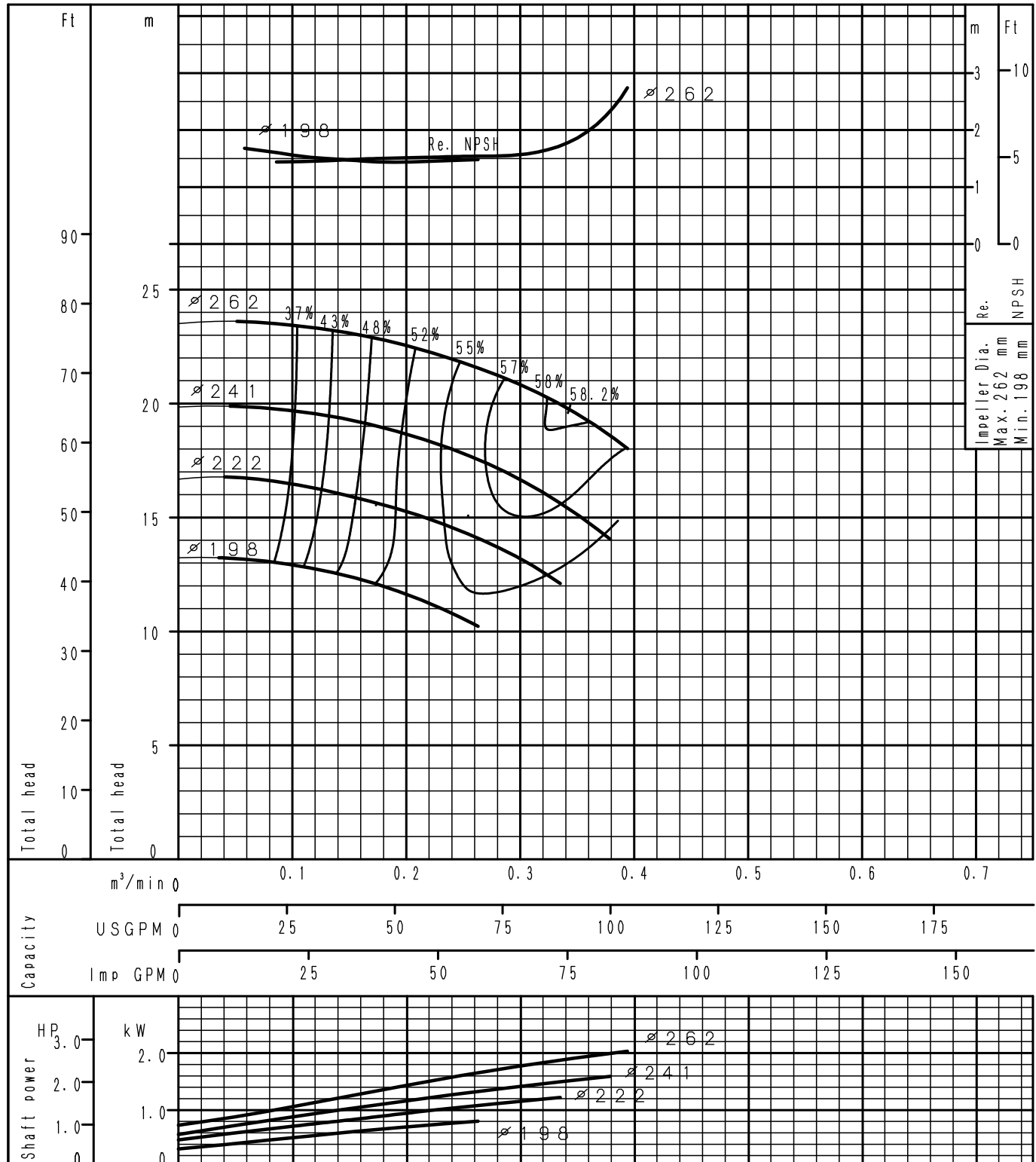

Performance Curve

4 Poles

GS40-125	According to ISO testing code 9906 Grade 3B
50Hz ( Speed 1450 min <sup>-1</sup> )	
DENSITY= 1.0 kg/l , VISCOSITY= 1.0 mPa·s	

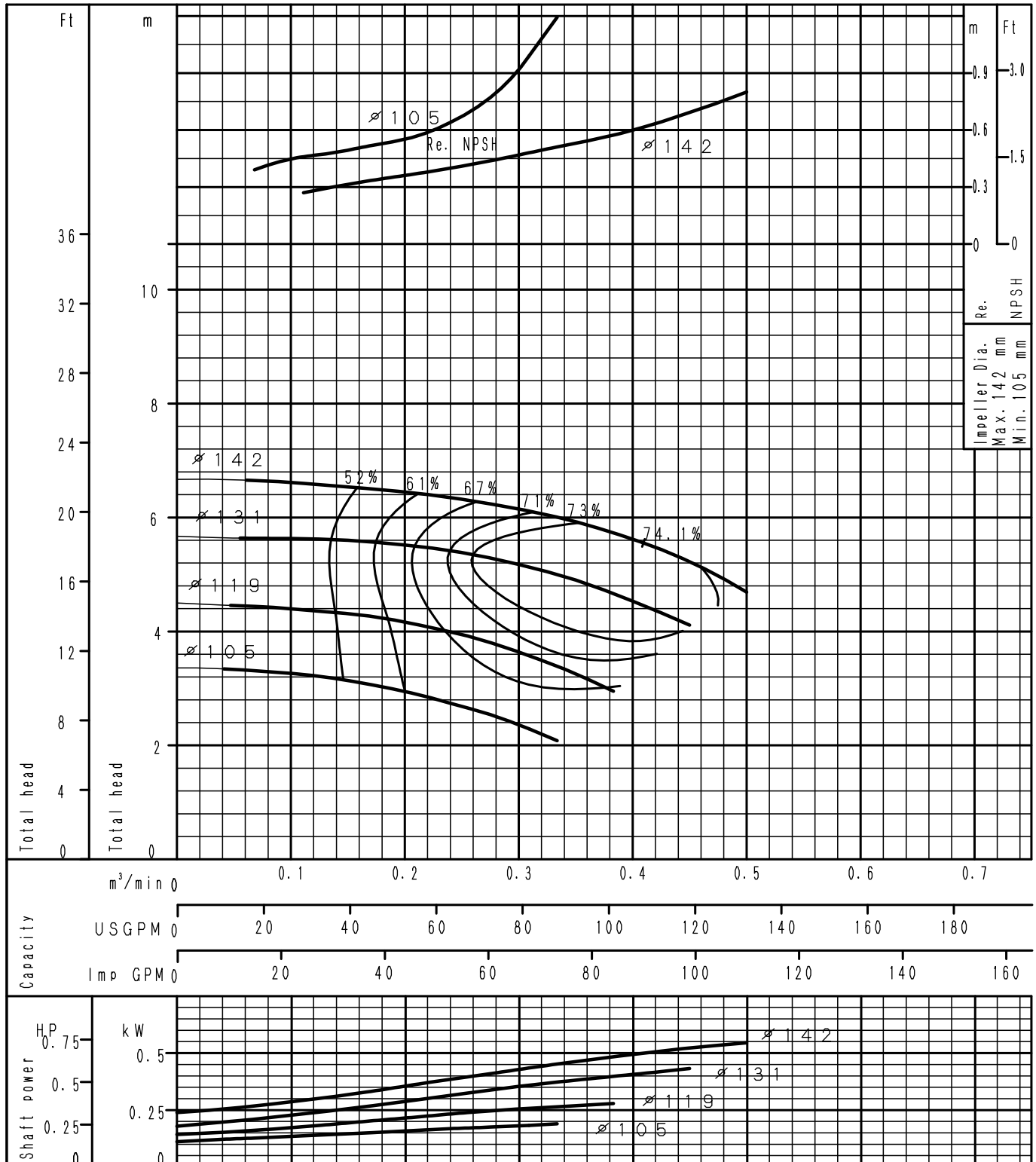



Performance Curve

4 Poles

<h1 style="margin: 0;">GS40-160</h1>	According to ISO testing code 9906 Grade 3B
50Hz ( Speed 1450 min <sup>-1</sup> )	DENSITY= 1.0 kg/l , VISCOSITY= 1.0 mPa·s

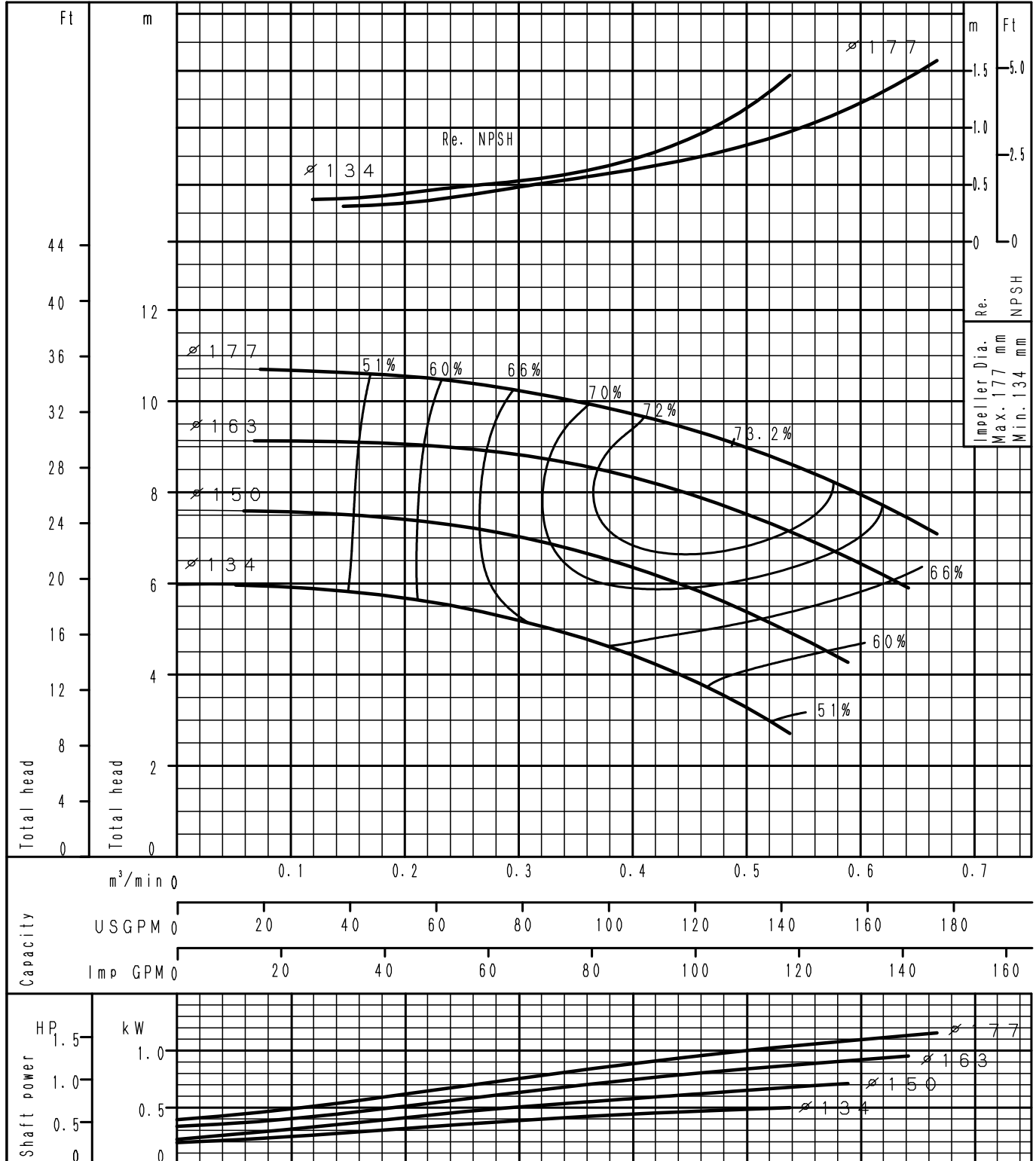

Performance Curve

4 Poles

GS40-200	According to ISO testing code 9906 Grade 3B
50Hz ( Speed 1450 min <sup>-1</sup> )	DENSITY= 1.0 kg/l , VISCOSITY= 1.0 mPa·s

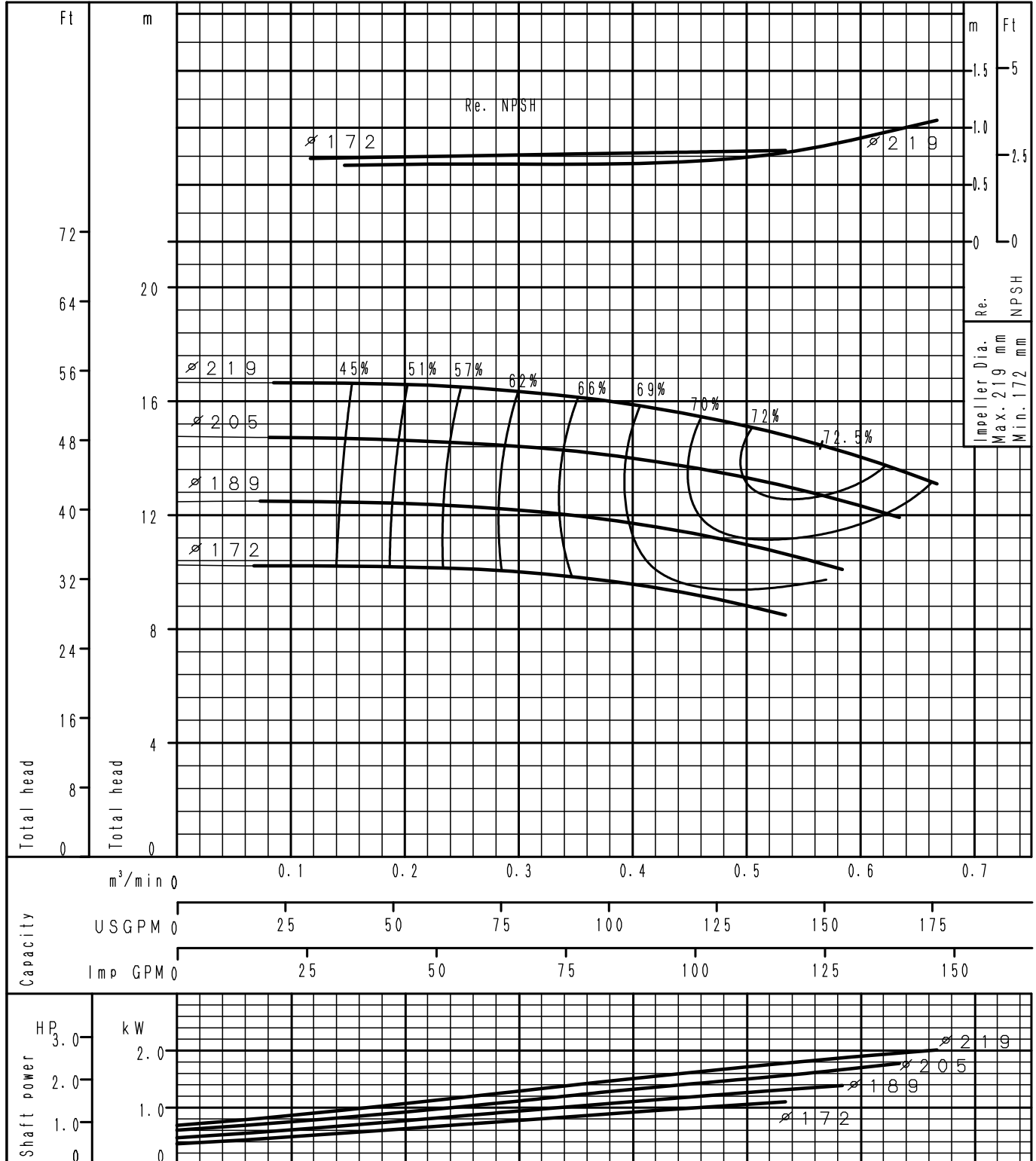

Performance Curve

4 Poles

<h1 style="margin: 0;">GS40-250</h1>	According to ISO testing code 9906 Grade 3B
50Hz ( Speed 1450 min <sup>-1</sup> )	DENSITY= 1.0 kg/l , VISCOSITY= 1.0 mPa·s

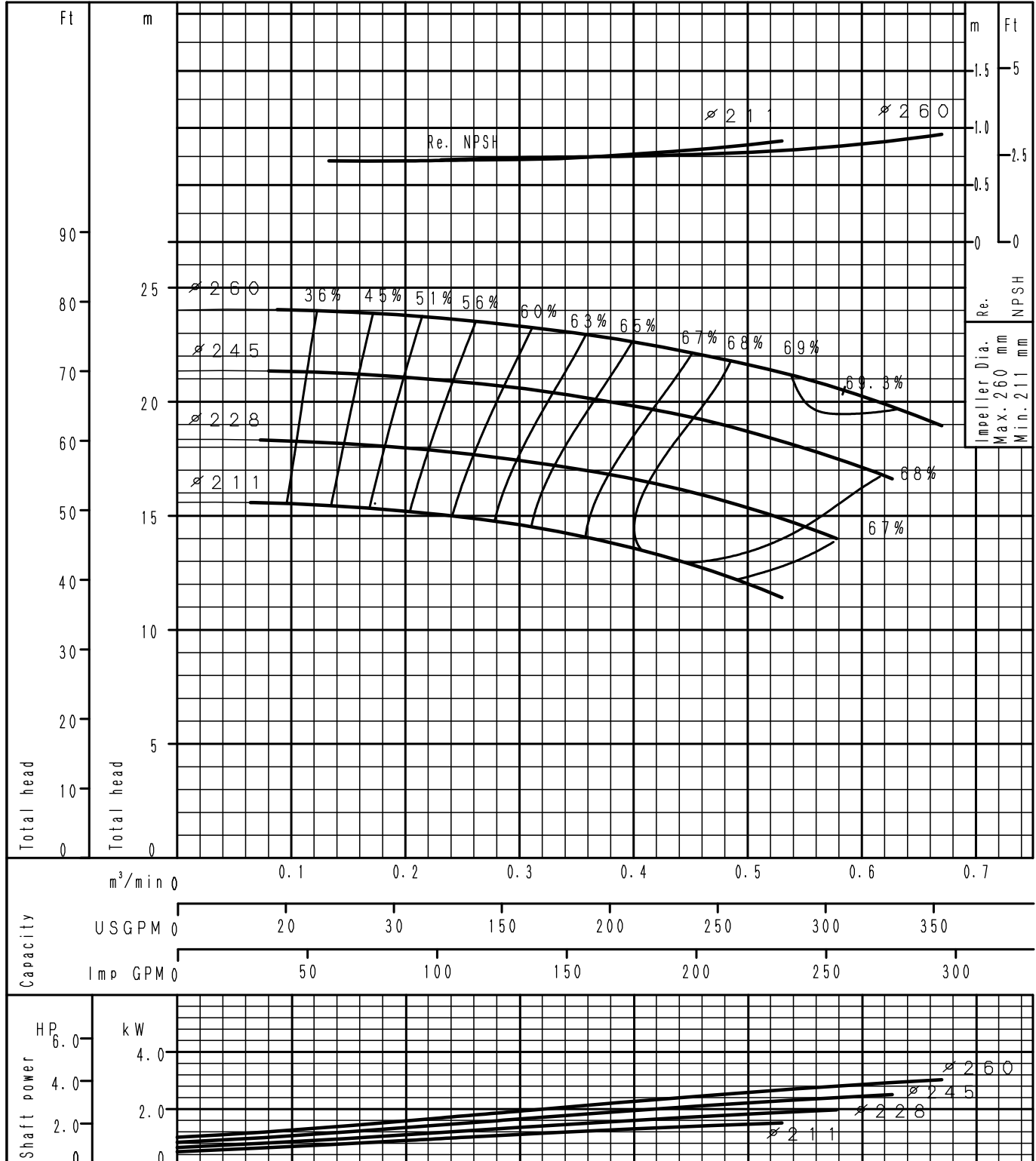

Performance Curve

4 Poles

GS40-315	According to ISO testing code 9906 Grade 3B
50Hz ( Speed 1450 min <sup>-1</sup> )	DENSITY= 1.0 kg/l , VISCOSITY= 1.0 mPa·s

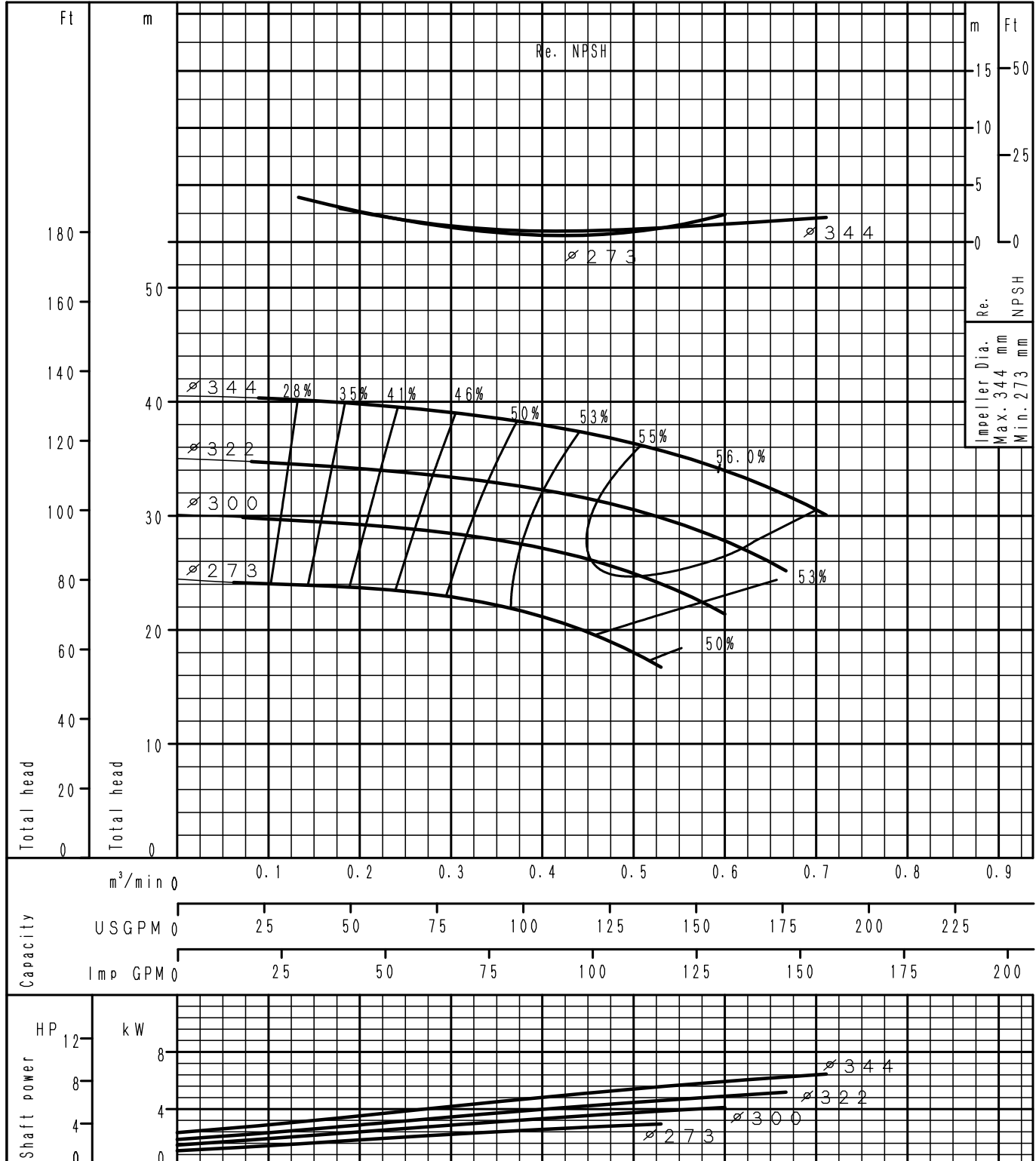

Performance Curve

4 Poles

GS50-125	According to ISO testing code 9906 Grade 3B
50Hz ( Speed 1450 min <sup>-1</sup> )	DENSITY= 1.0 kg/l , VISCOSITY= 1.0 mPa·s

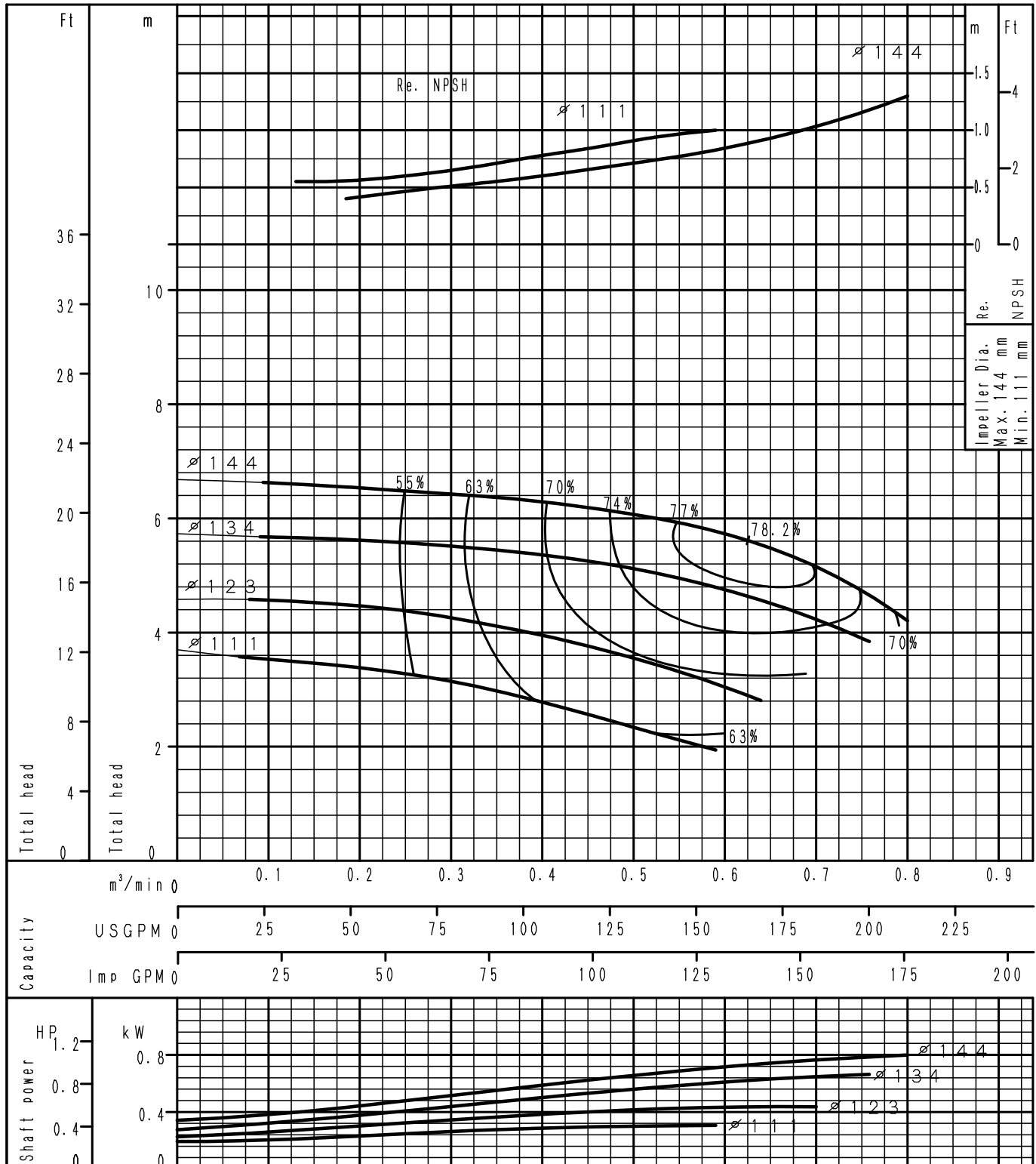

Performance Curve

4 Poles

GS50-160	According to ISO testing code 9906 Grade 3B
50Hz ( Speed 1450 min <sup>-1</sup> )	DENSITY= 1.0 kg/l , VISCOSITY= 1.0 mPa·s

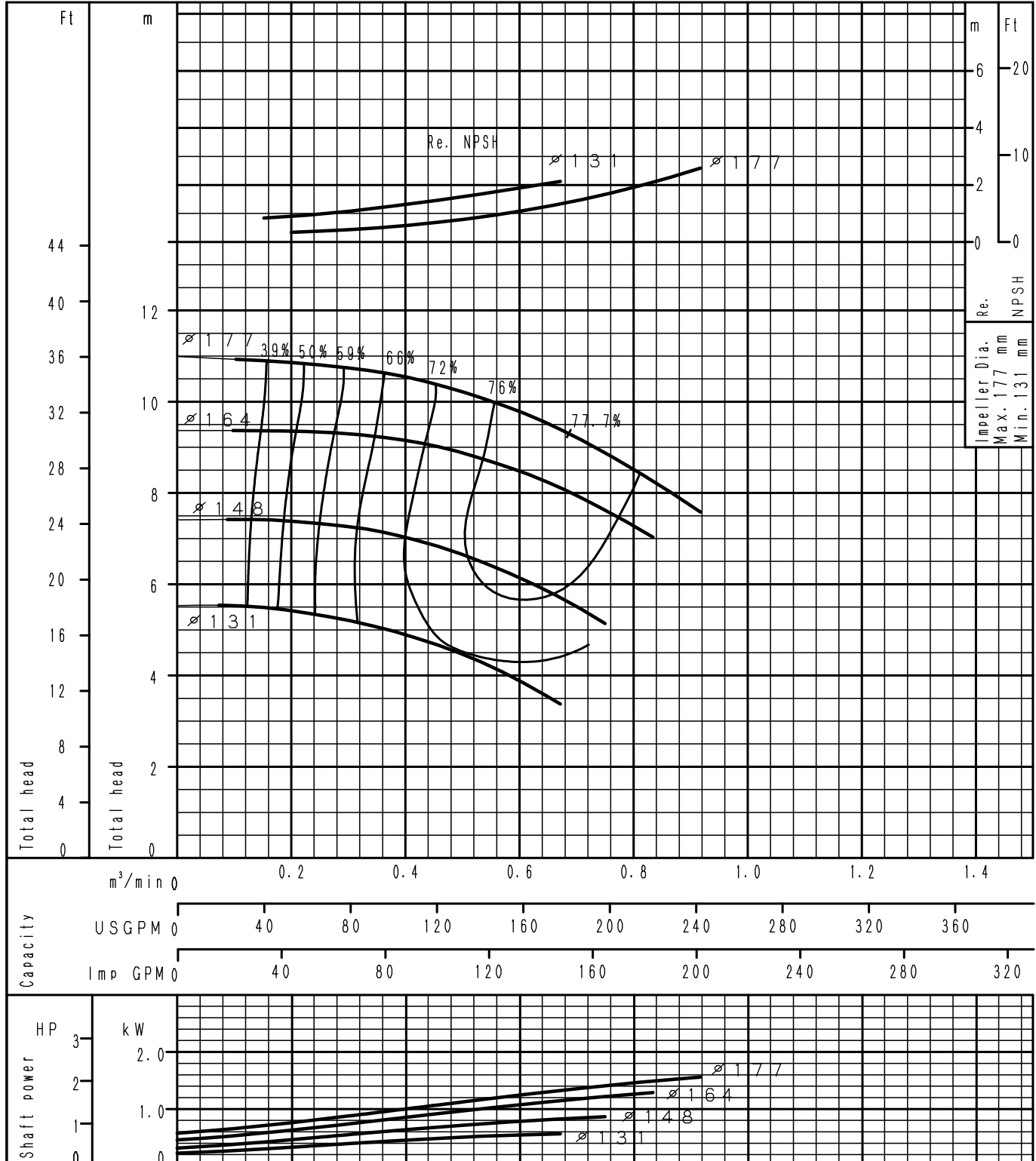

Performance Curve

4 Poles

GS50-200	According to ISO testing code 9906 Grade 3B
50Hz ( Speed 1450 min <sup>-1</sup> )	DENSITY= 1.0 kg/l , VISCOSITY= 1.0 mPa·s

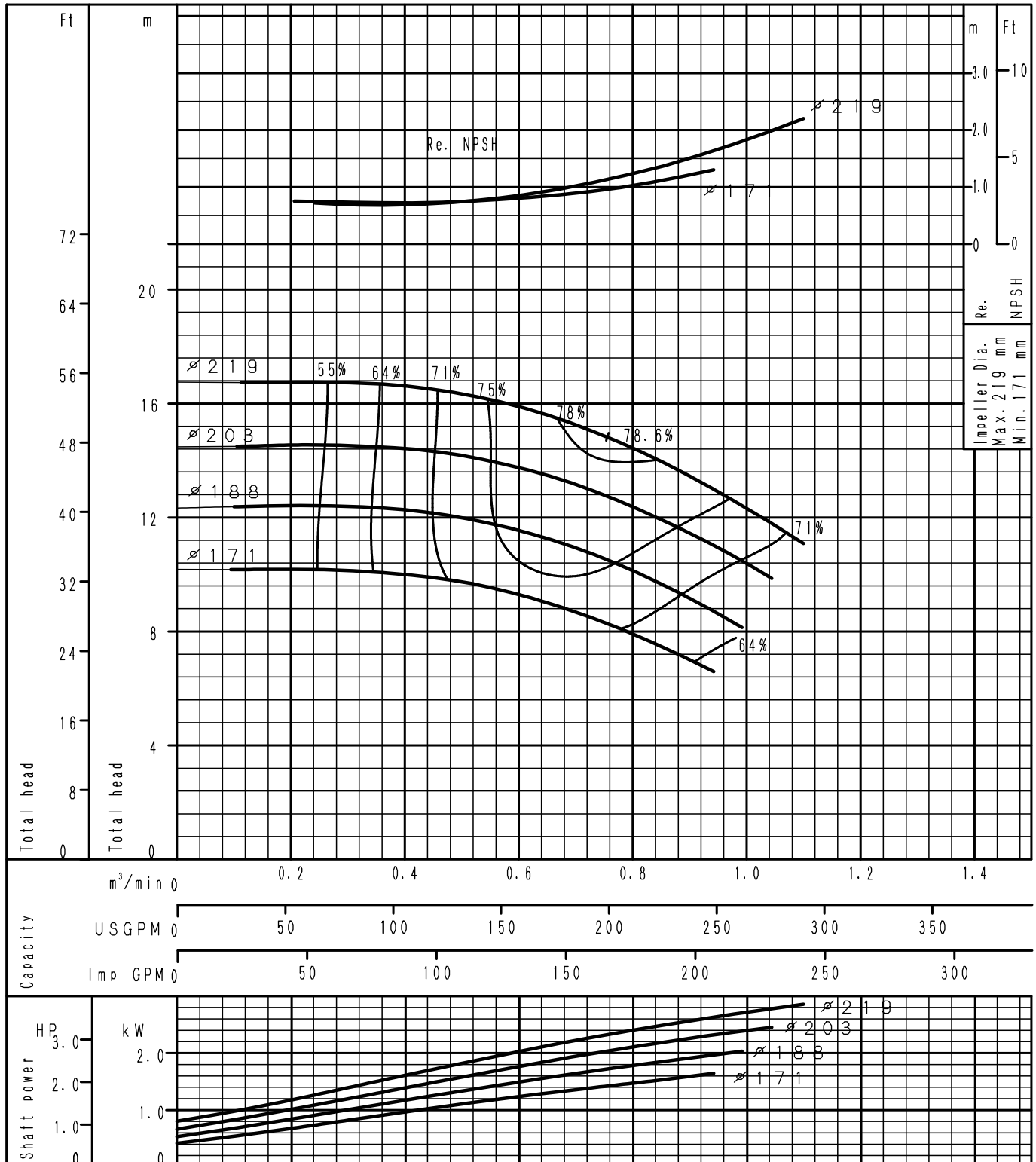

Performance Curve

4 Poles

GS50-250	According to ISO testing code 9906 Grade 3B
50Hz ( Speed 1450 min <sup>-1</sup> )	
DENSITY= 1.0 kg/l , VISCOSITY= 1.0 mPa·s	

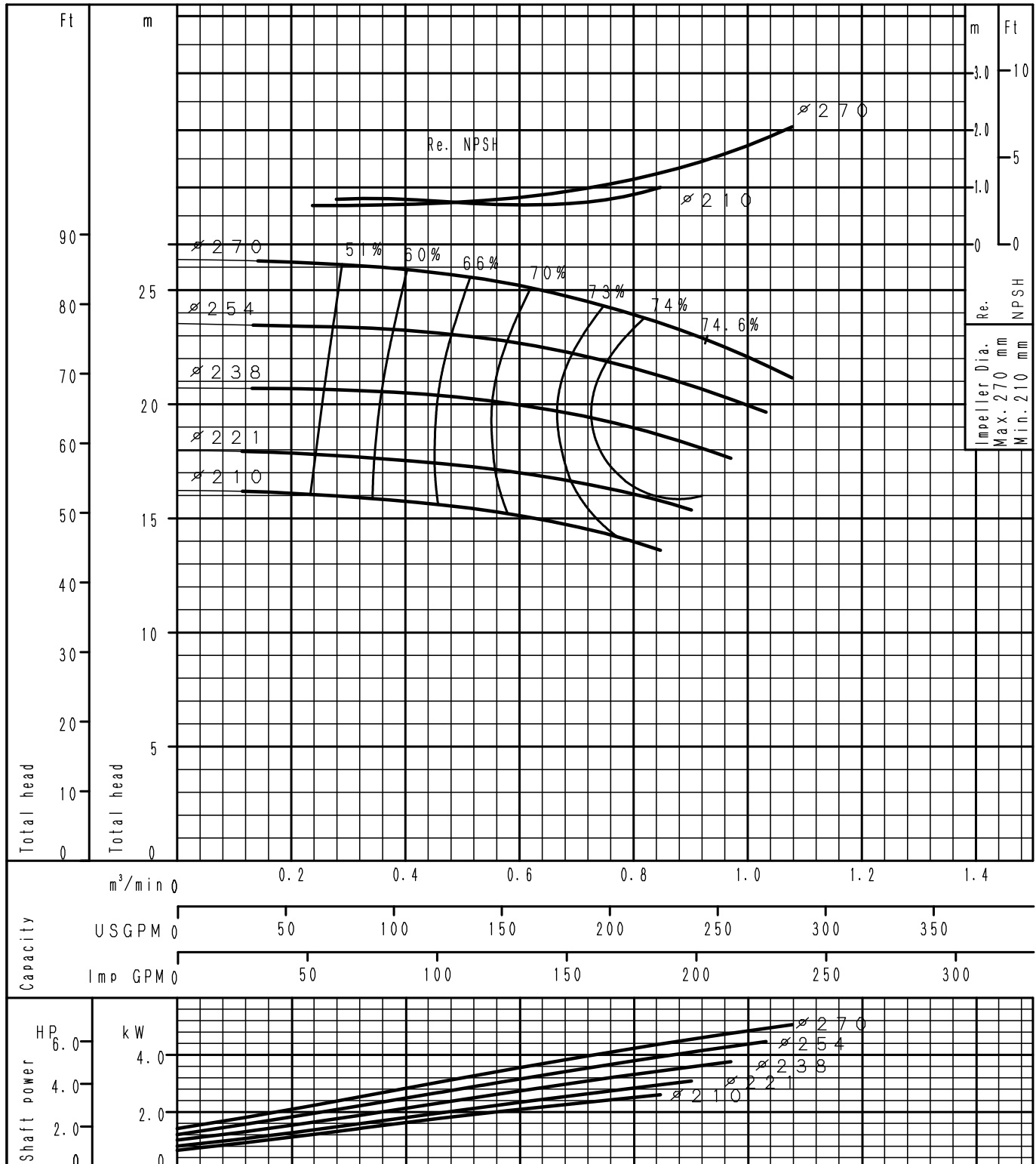



Performance Curve

4 Poles

GS50-315	According to ISO testing code 9906 Grade 3B
50Hz ( Speed 1450 min <sup>-1</sup> )	DENSITY= 1.0 kg/l , VISCOSITY= 1.0 mPa·s

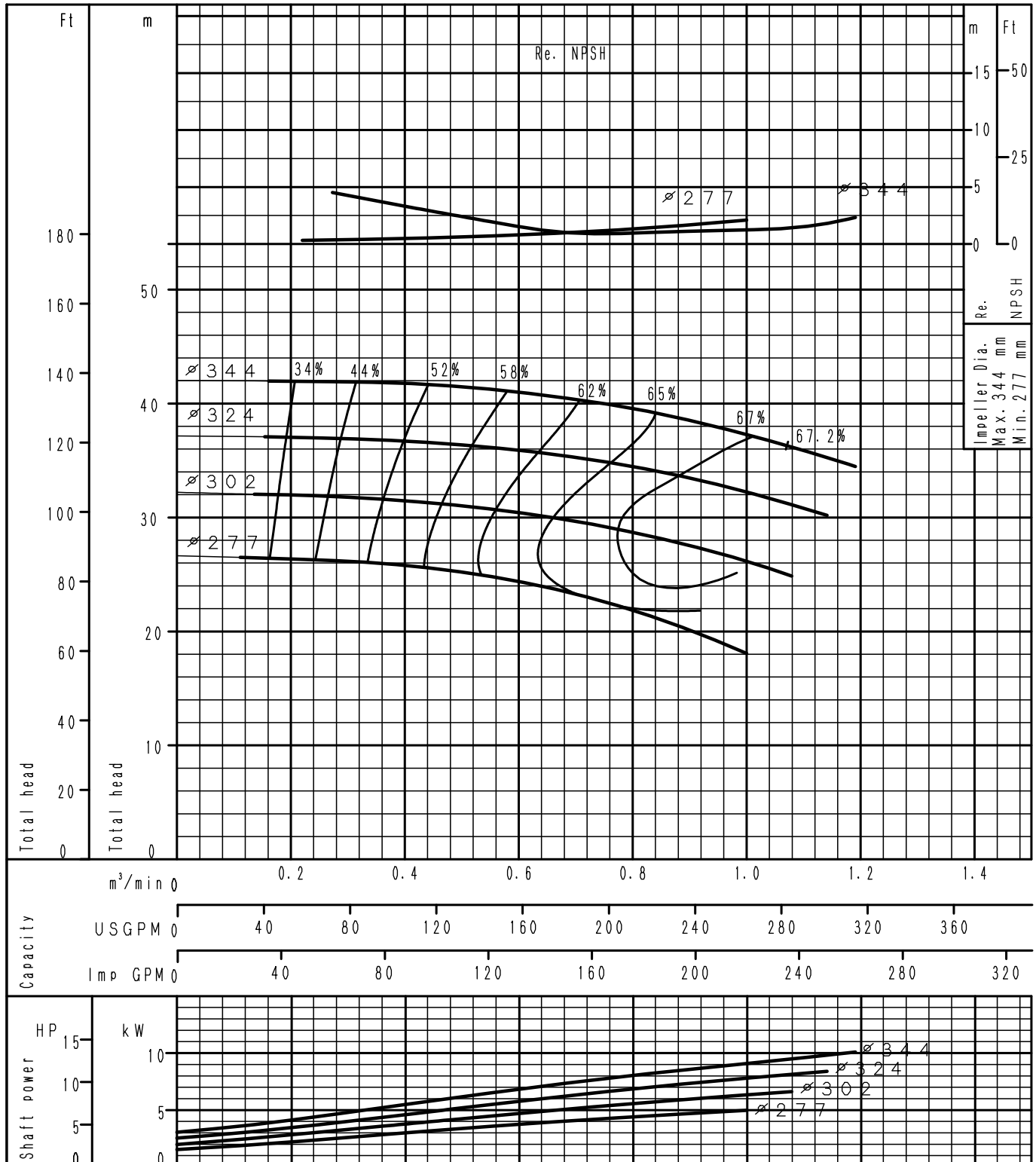

Performance Curve

4 Poles

GS65-125	According to ISO testing code 9906 Grade 3B
50Hz ( Speed 1450 min <sup>-1</sup> )	DENSITY= 1.0 kg/l , VISCOSITY= 1.0 mPa·s

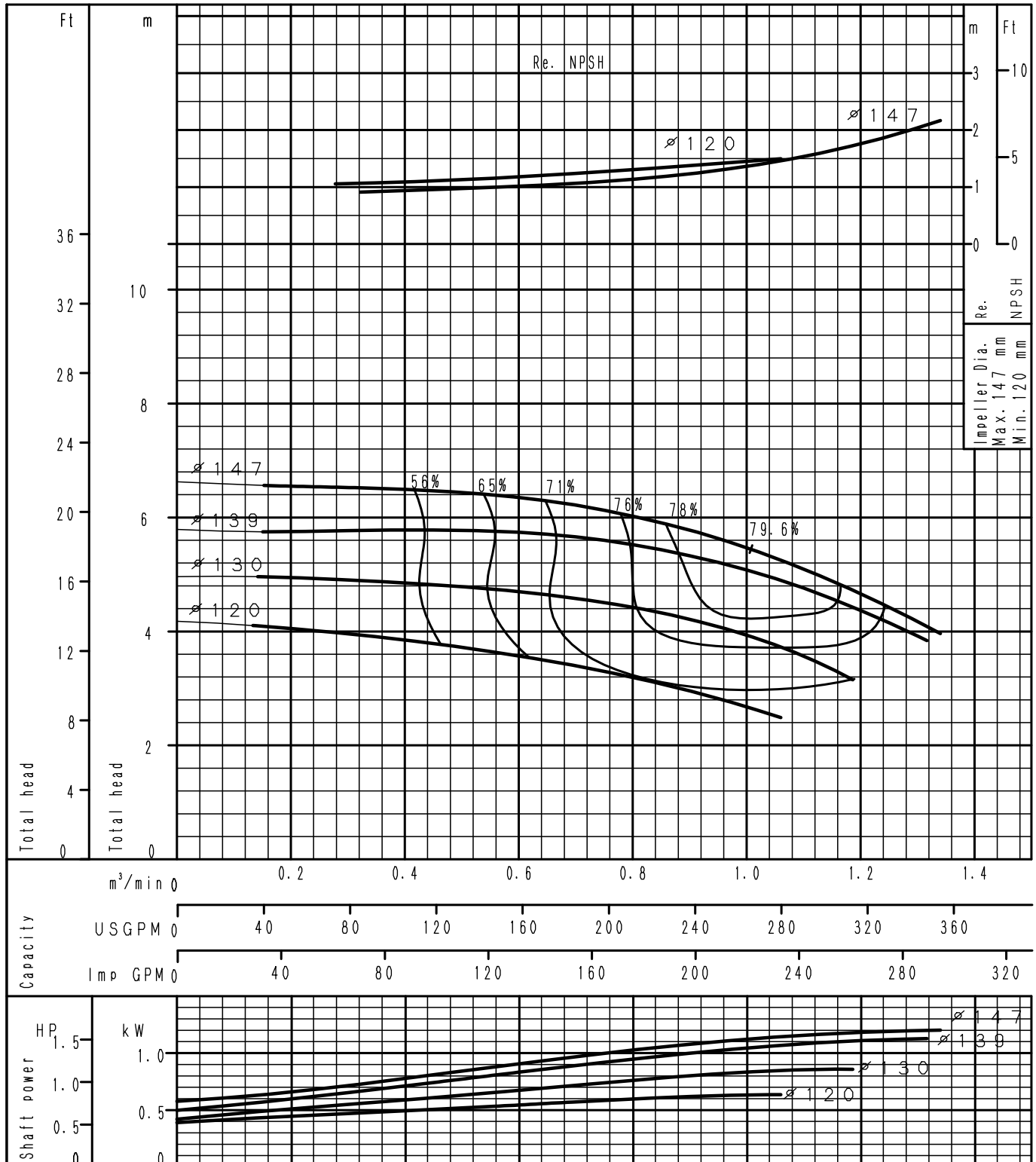

Performance Curve

4 Poles

GS65-160	According to ISO testing code 9906 Grade 3B
50Hz ( Speed 1450 min <sup>-1</sup> )	DENSITY= 1.0 kg/l , VISCOSITY= 1.0 mPa·s

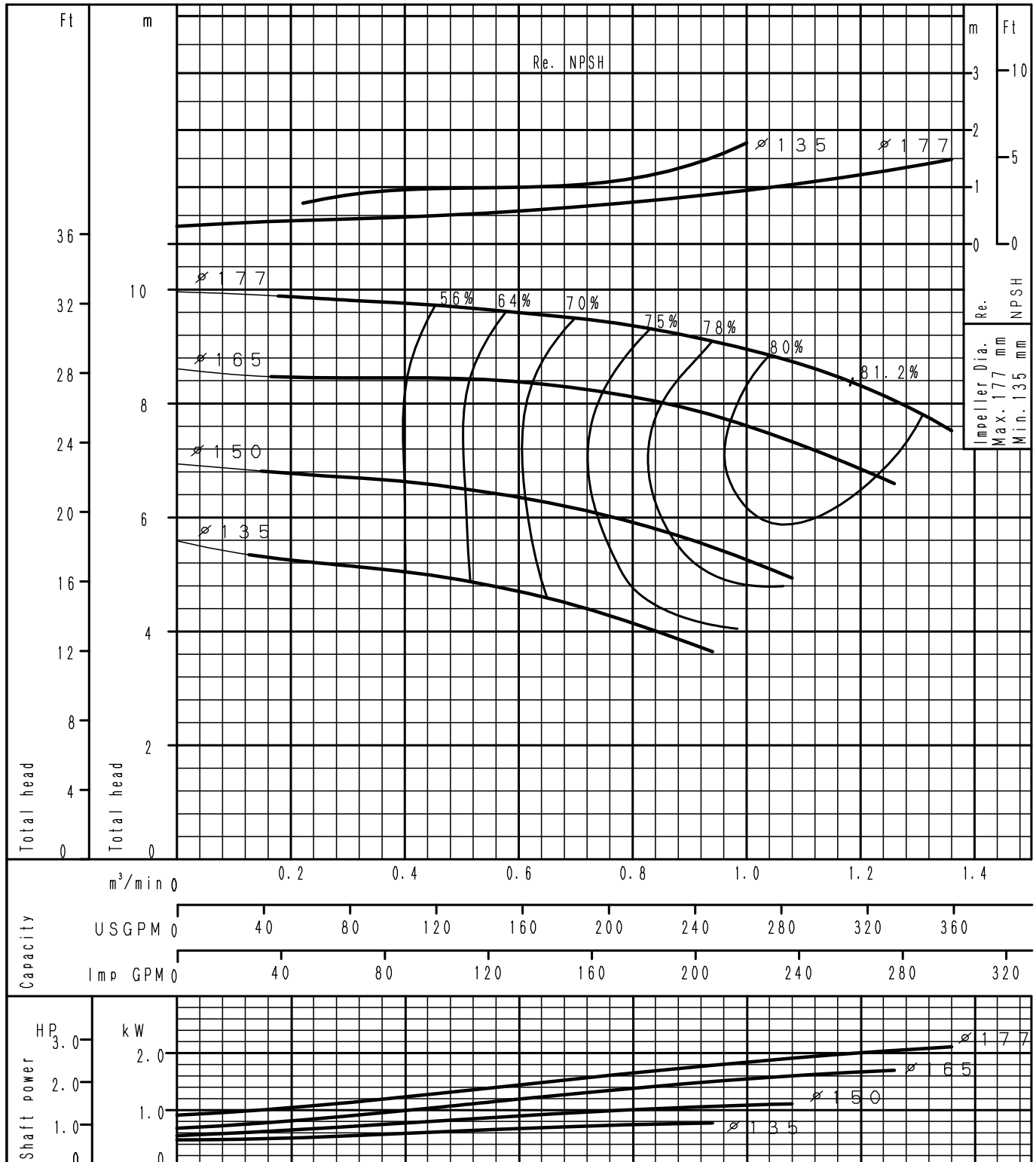

Performance Curve

4 Poles

GS65-200	According to ISO testing code 9906 Grade 3B
50Hz ( Speed 1450 min <sup>-1</sup> )	DENSITY= 1.0 kg/l , VISCOSITY= 1.0 mPa·s

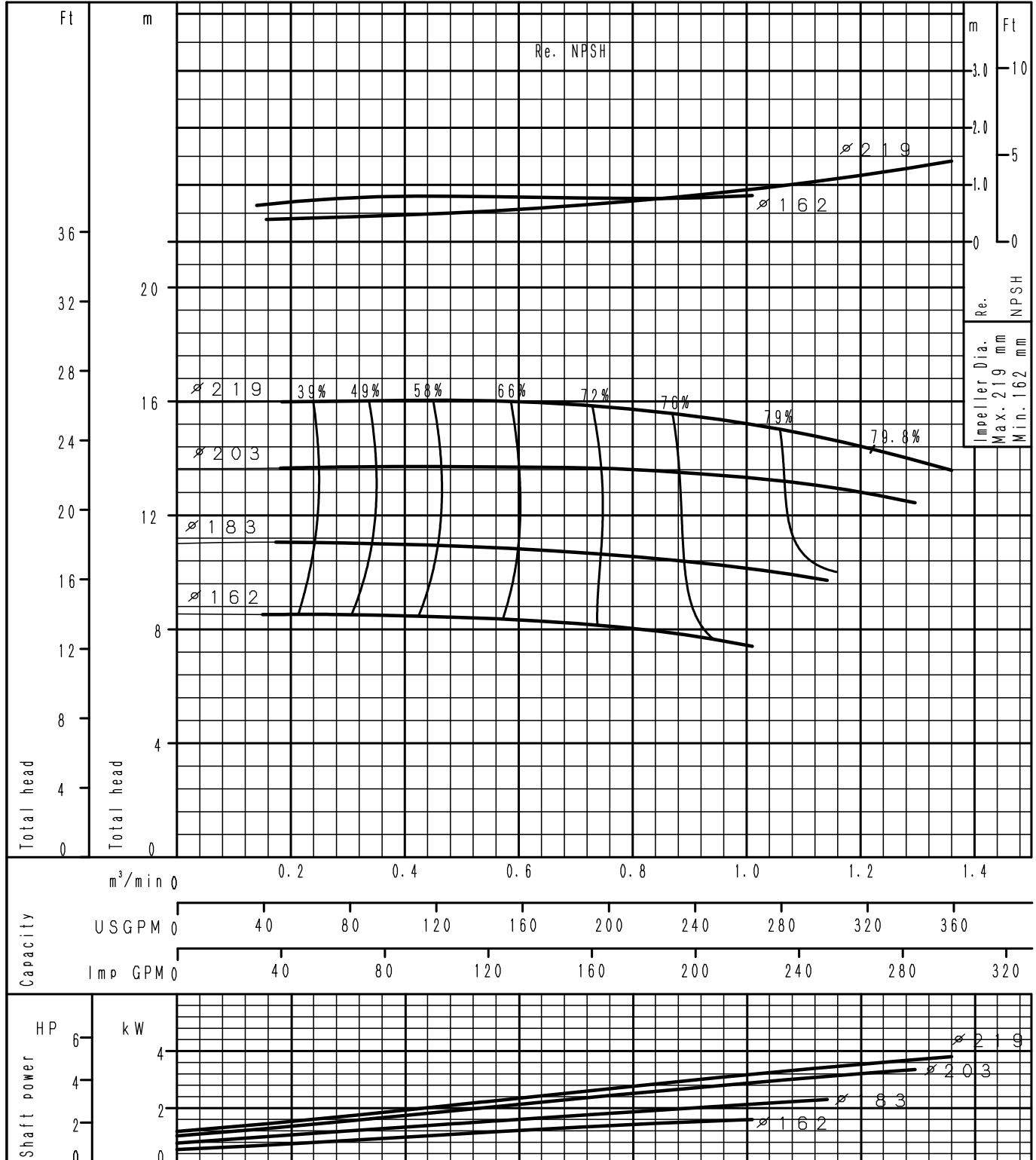

Performance Curve

4 Poles

GS65-250	According to ISO testing code 9906 Grade 3B
50Hz ( Speed 1450 min <sup>-1</sup> )	DENSITY= 1.0 kg/l , VISCOSITY= 1.0 mPa·s

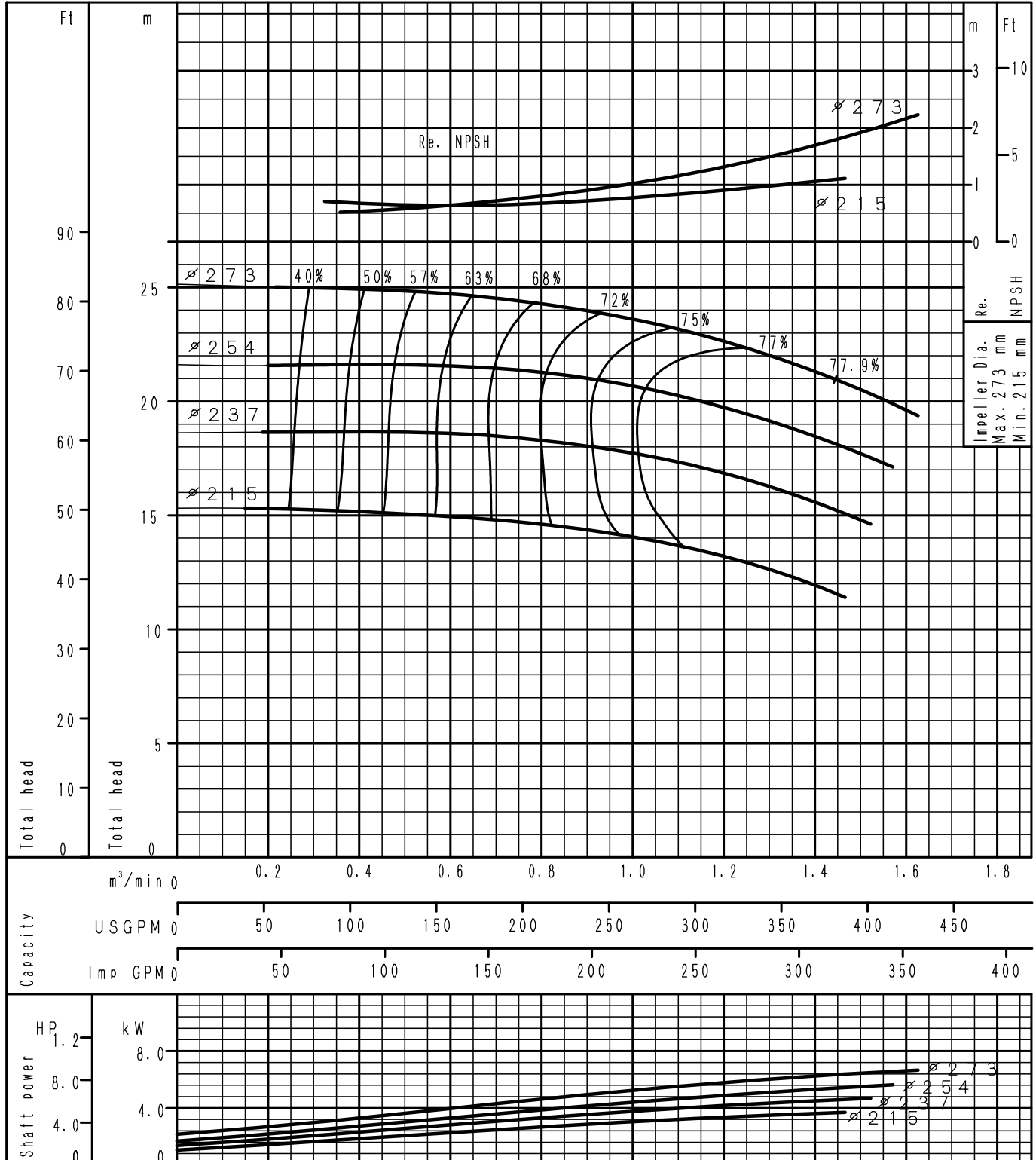

Performance Curve

4 Poles

GS65-315	According to ISO testing code 9906 Grade 3B
50Hz ( Speed 1450 min <sup>-1</sup> )	DENSITY= 1.0 kg/l , VISCOSITY= 1.0 mPa·s

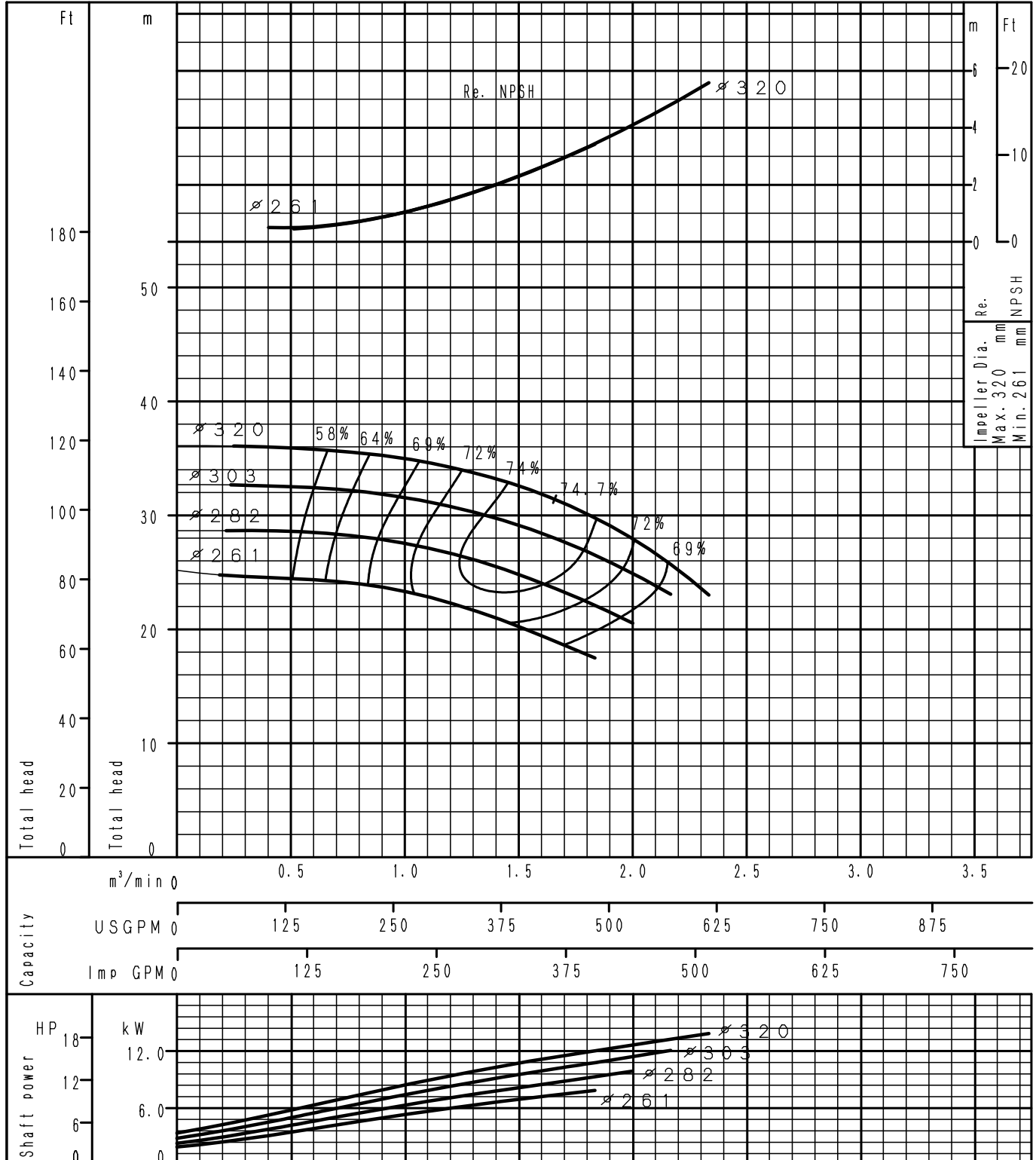

Performance Curve

4 Poles

GS80-160	According to ISO testing code 9906 Grade 3B
50Hz ( Speed 1450 min <sup>-1</sup> )	DENSITY= 1.0 kg/l , VISCOSITY= 1.0 mPa·s

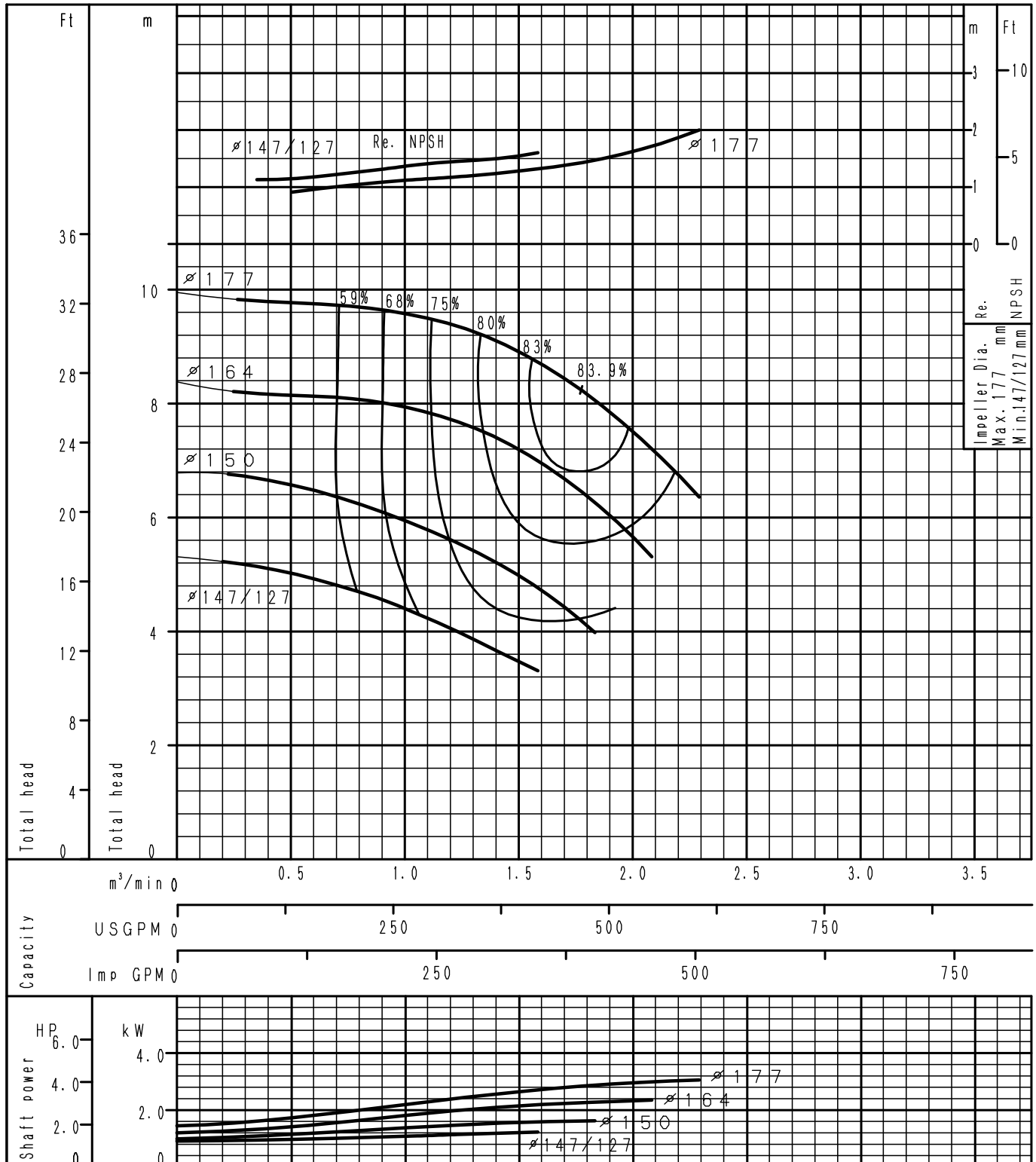

Performance Curve

4 Poles

GS80-200	According to ISO testing code 9906 Grade 3B
50Hz ( Speed 1450 min <sup>-1</sup> )	DENSITY= 1.0 kg/l , VISCOSITY= 1.0 mPa·s

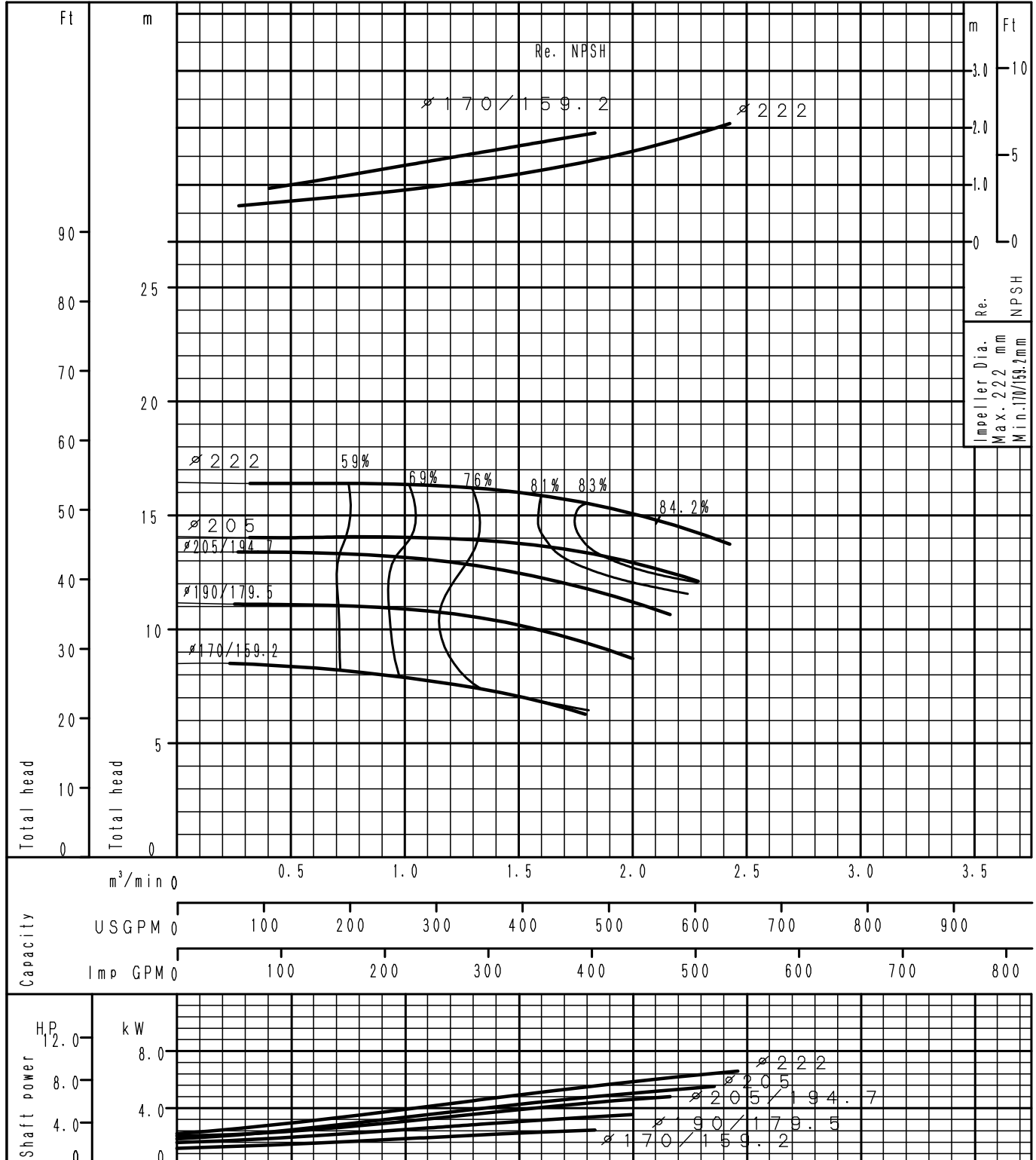



Performance Curve

4 Poles

GS80-250	According to ISO testing code 9906 Grade 3B
50Hz ( Speed 1450 min <sup>-1</sup> )	DENSITY= 1.0 kg/l , VISCOSITY= 1.0 mPa·s

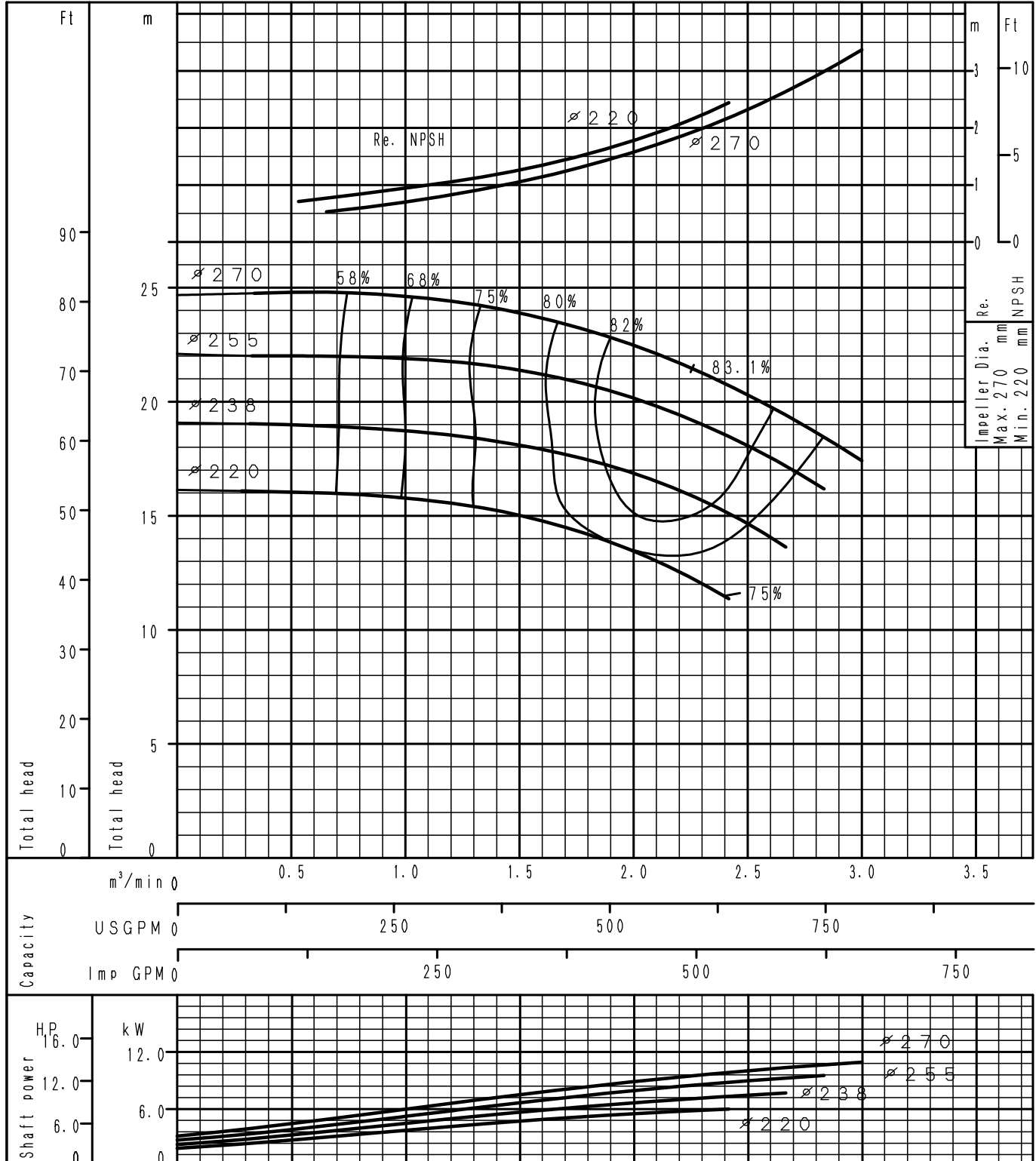

Performance Curve

4 Poles

<h1 style="margin: 0;">GS80-315</h1>	According to ISO testing code 9906 Grade 3B
50Hz ( Speed 1450 min <sup>-1</sup> )	DENSITY= 1.0 kg/l , VISCOSITY= 1.0 mPa·s

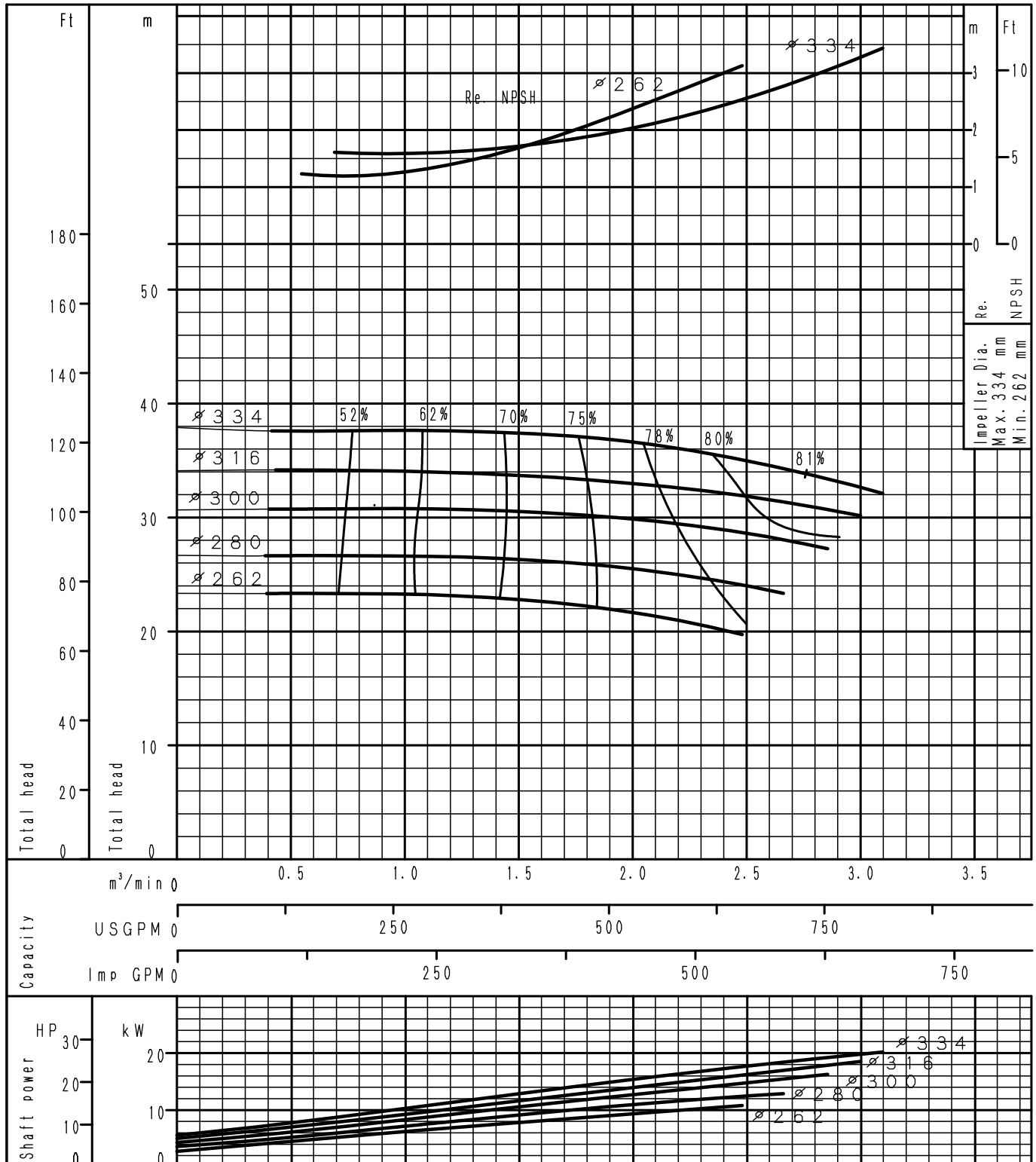

Performance Curve

4 Poles

<h1 style="margin: 0;">GS80-400</h1>	According to ISO testing code 9906 Grade 3B
50Hz ( Speed 1450 min <sup>-1</sup> )	DENSITY= 1.0 kg/l , VISCOSITY= 1.0 mPa·s

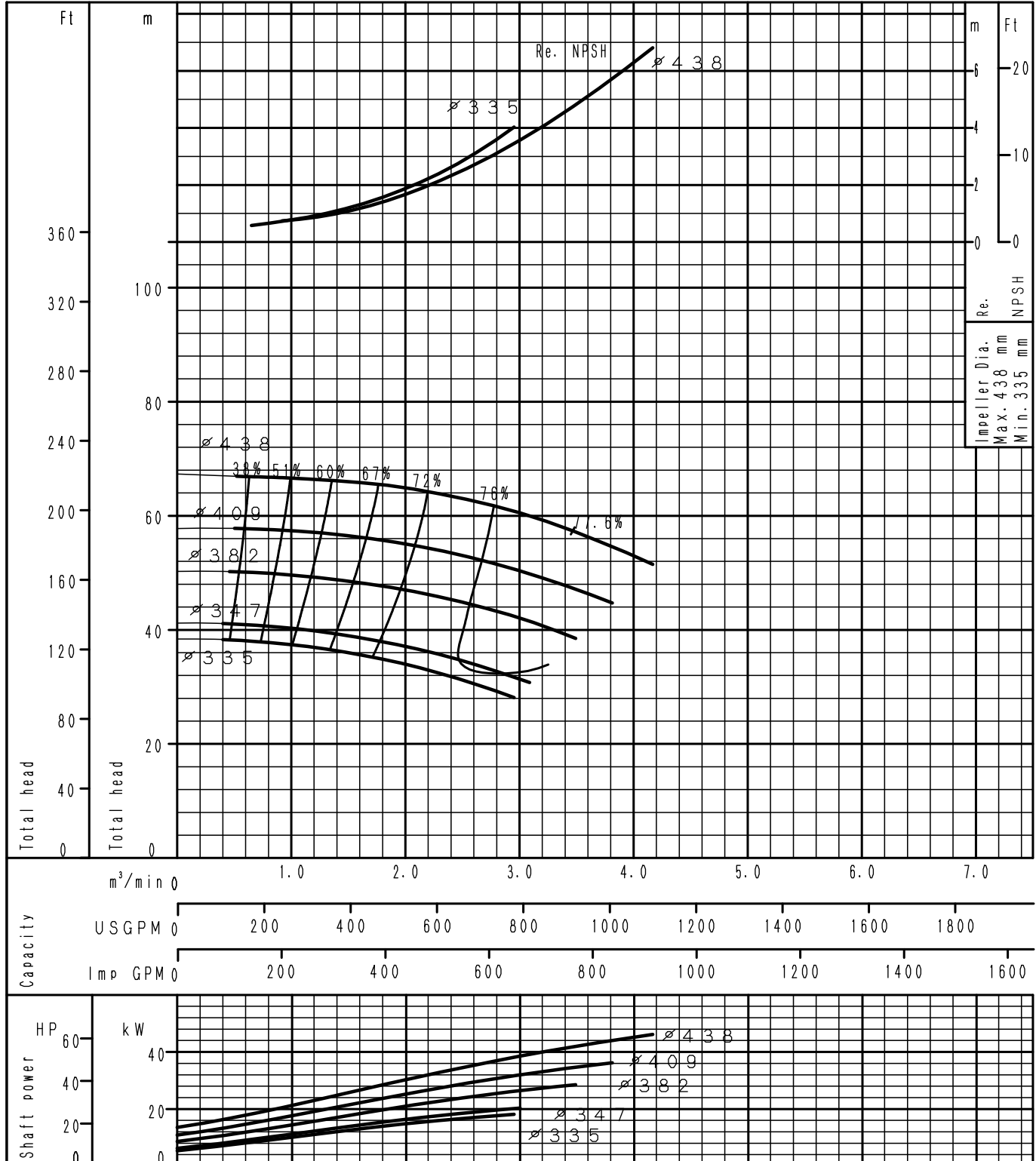

Performance Curve

4 Poles

GS100-160	According to ISO testing code 9906 Grade 3B
50Hz ( Speed 1450 min <sup>-1</sup> )	DENSITY= 1.0 kg/l , VISCOSITY= 1.0 mPa·s

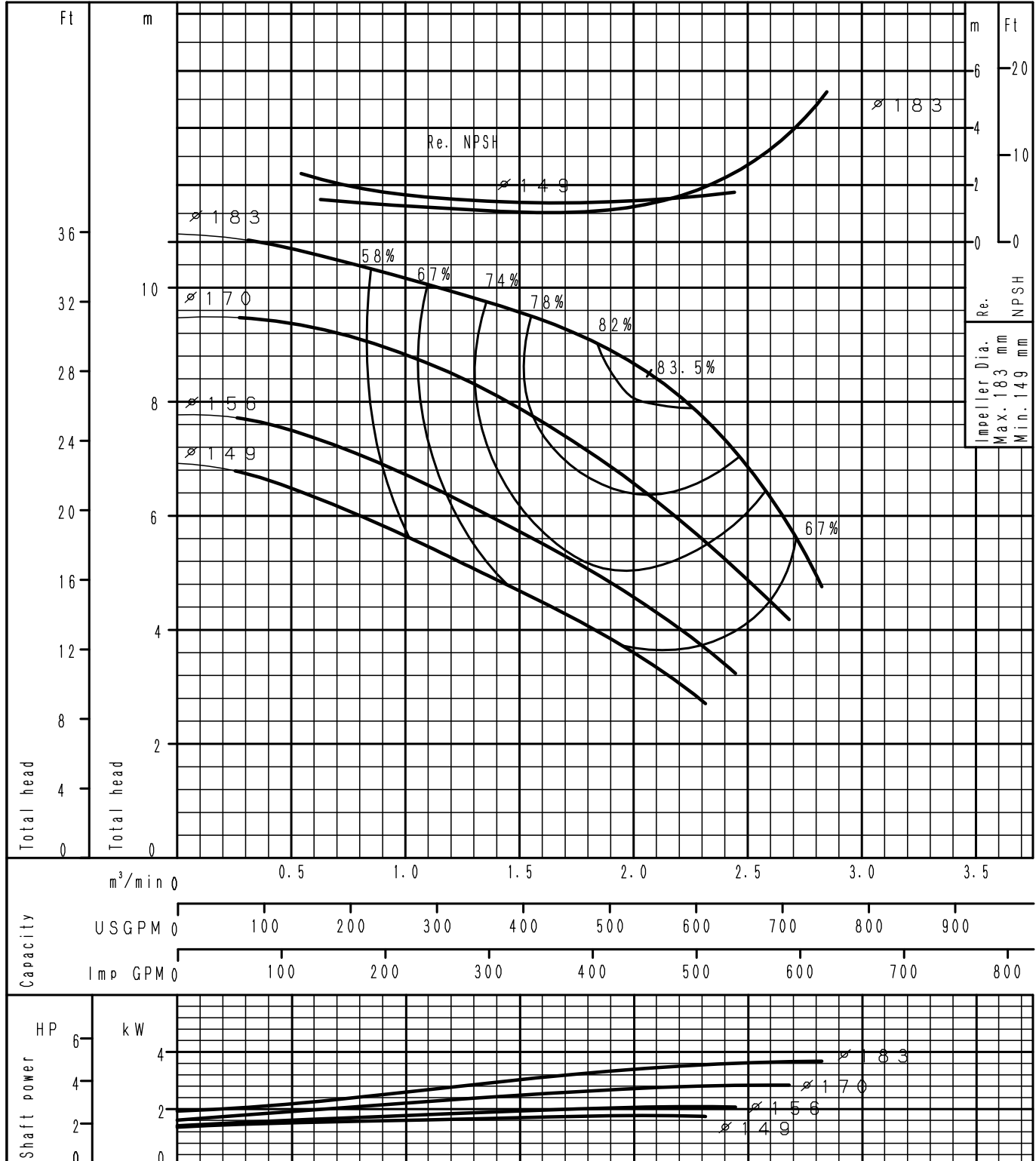

Performance Curve

4 Poles

GS100-200	According to ISO testing code 9906 Grade 3B
50Hz ( Speed 1450 min <sup>-1</sup> )	DENSITY= 1.0 kg/l , VISCOSITY= 1.0 mPa·s

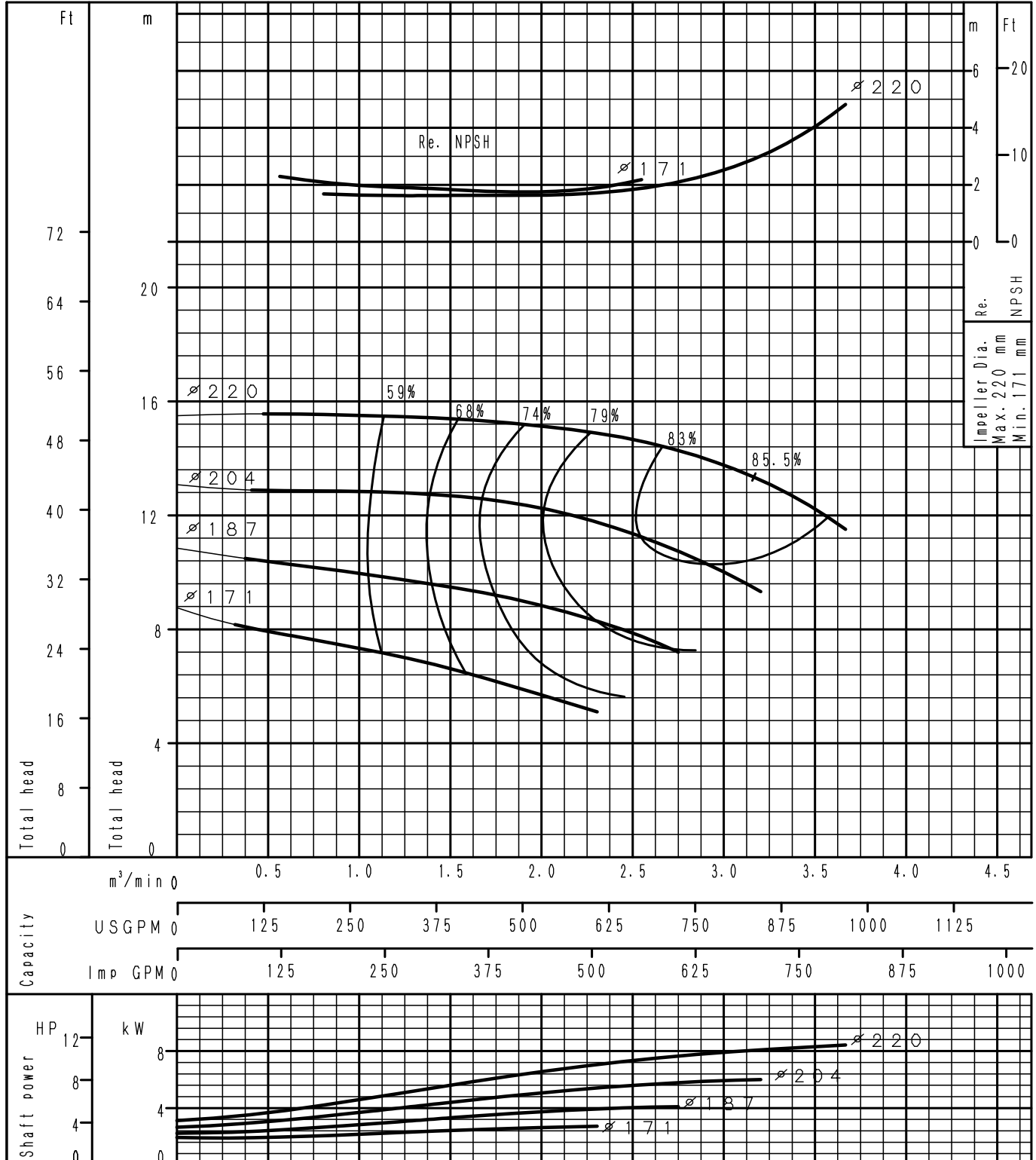

Performance Curve

4 Poles

GS100-250	According to ISO testing code 9906 Grade 3B
50Hz ( Speed 1450 min <sup>-1</sup> )	DENSITY= 1.0 kg/l , VISCOSITY= 1.0 mPa·s

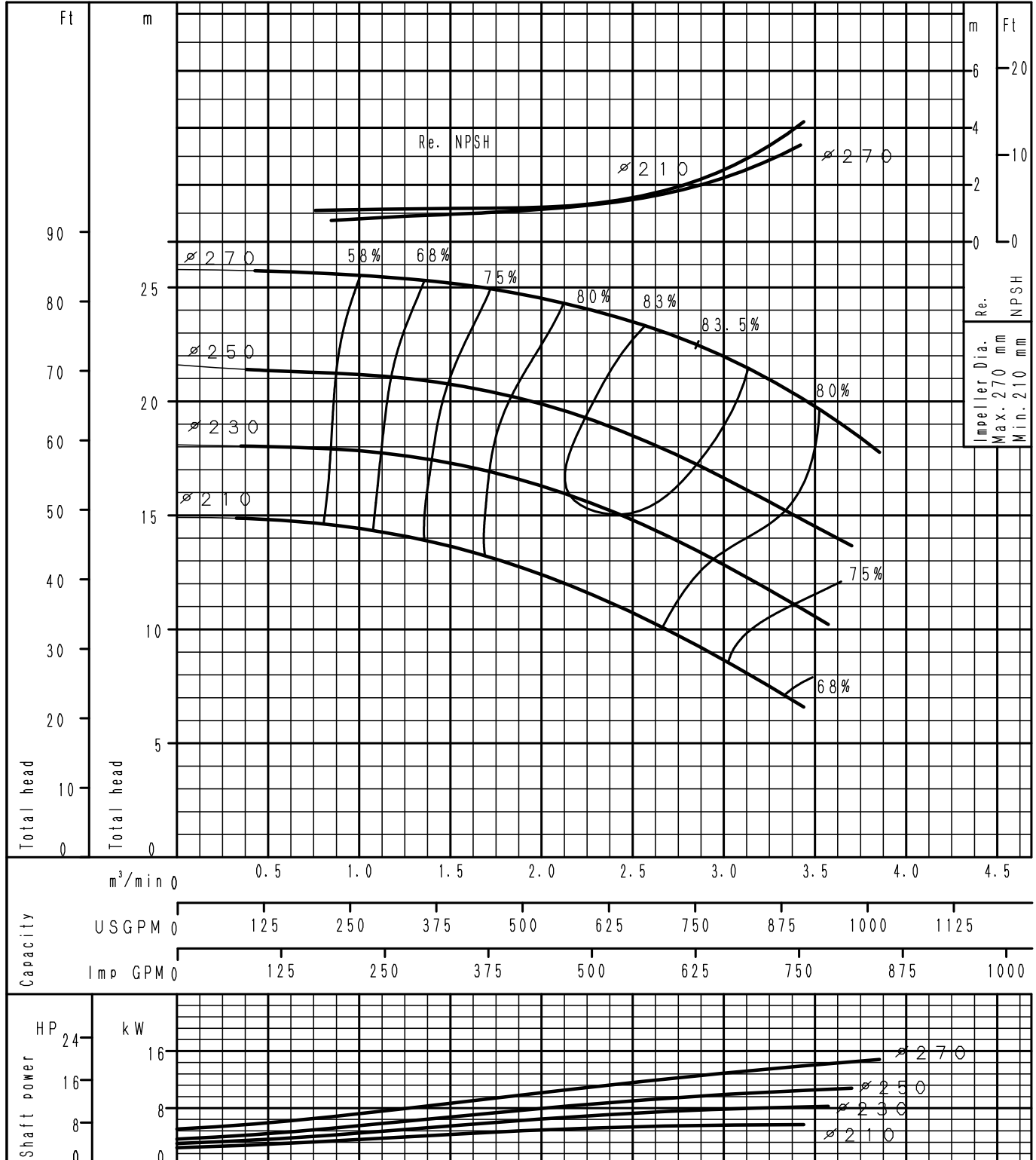

Performance Curve

4 Poles

GS100-315	According to ISO testing code 9906 Grade 3B
50Hz ( Speed 1450 min <sup>-1</sup> )	DENSITY= 1.0 kg/l , VISCOSITY= 1.0 mPa·s

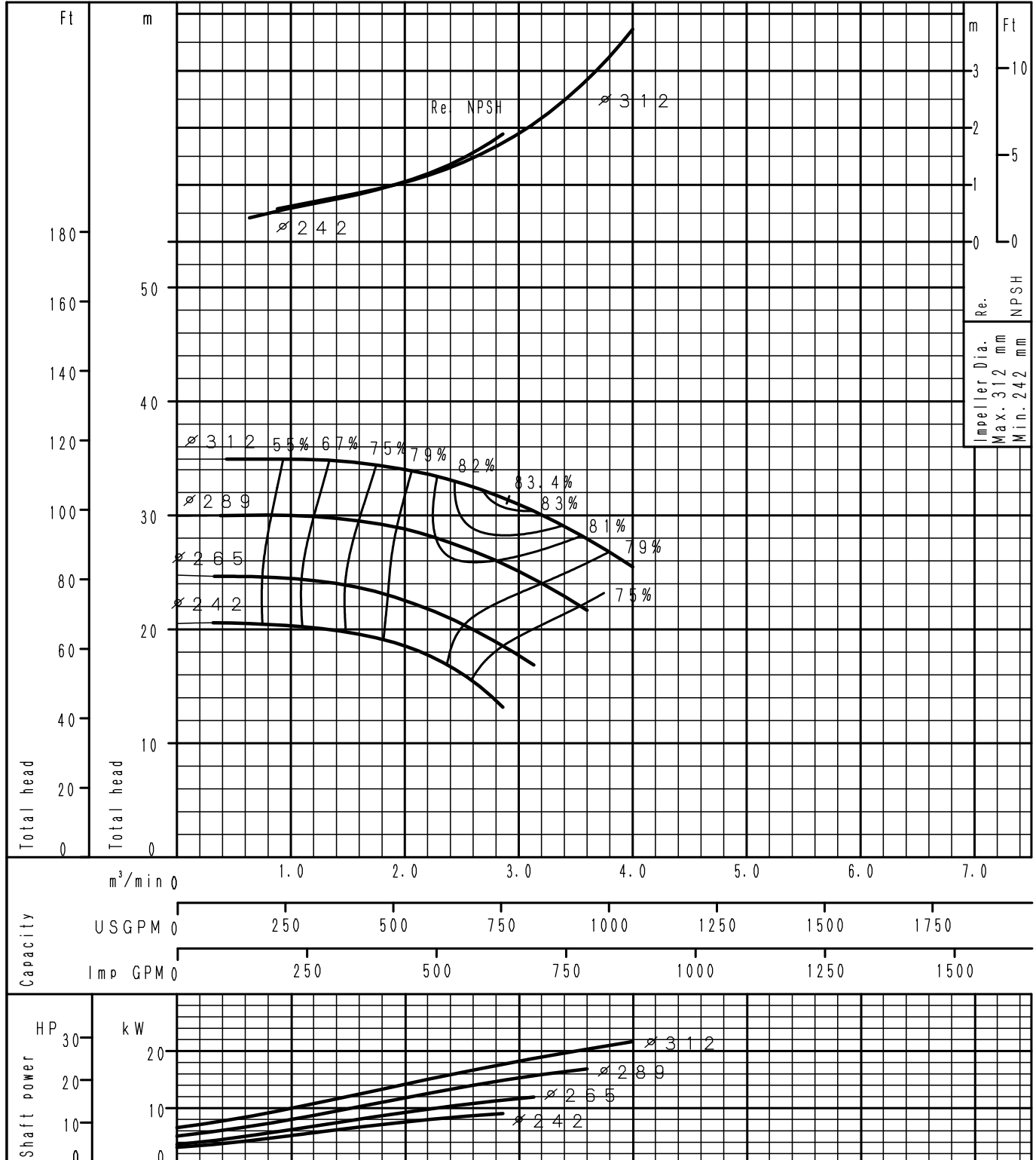

Performance Curve

4 Poles

GS100-400	According to ISO testing code 9906 Grade 3B
50Hz ( Speed 1450 min <sup>-1</sup> )	DENSITY= 1.0 kg/l , VISCOSITY= 1.0 mPa·s

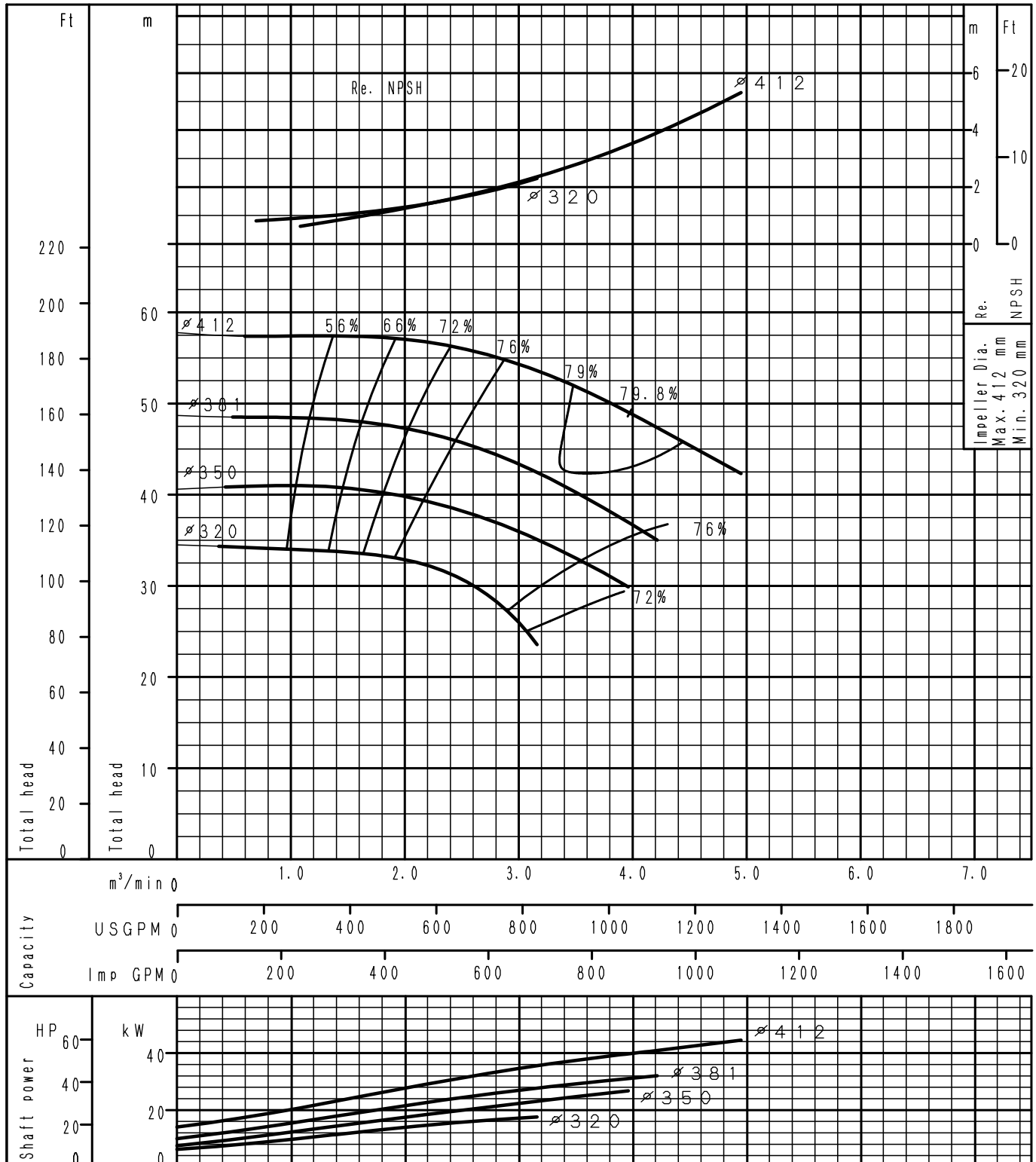



Performance Curve

4 Poles

GS125-200	According to ISO testing code 9906 Grade 3B
50Hz ( Speed 1450 min <sup>-1</sup> )	DENSITY= 1.0 kg/l , VISCOSITY= 1.0 mPa·s

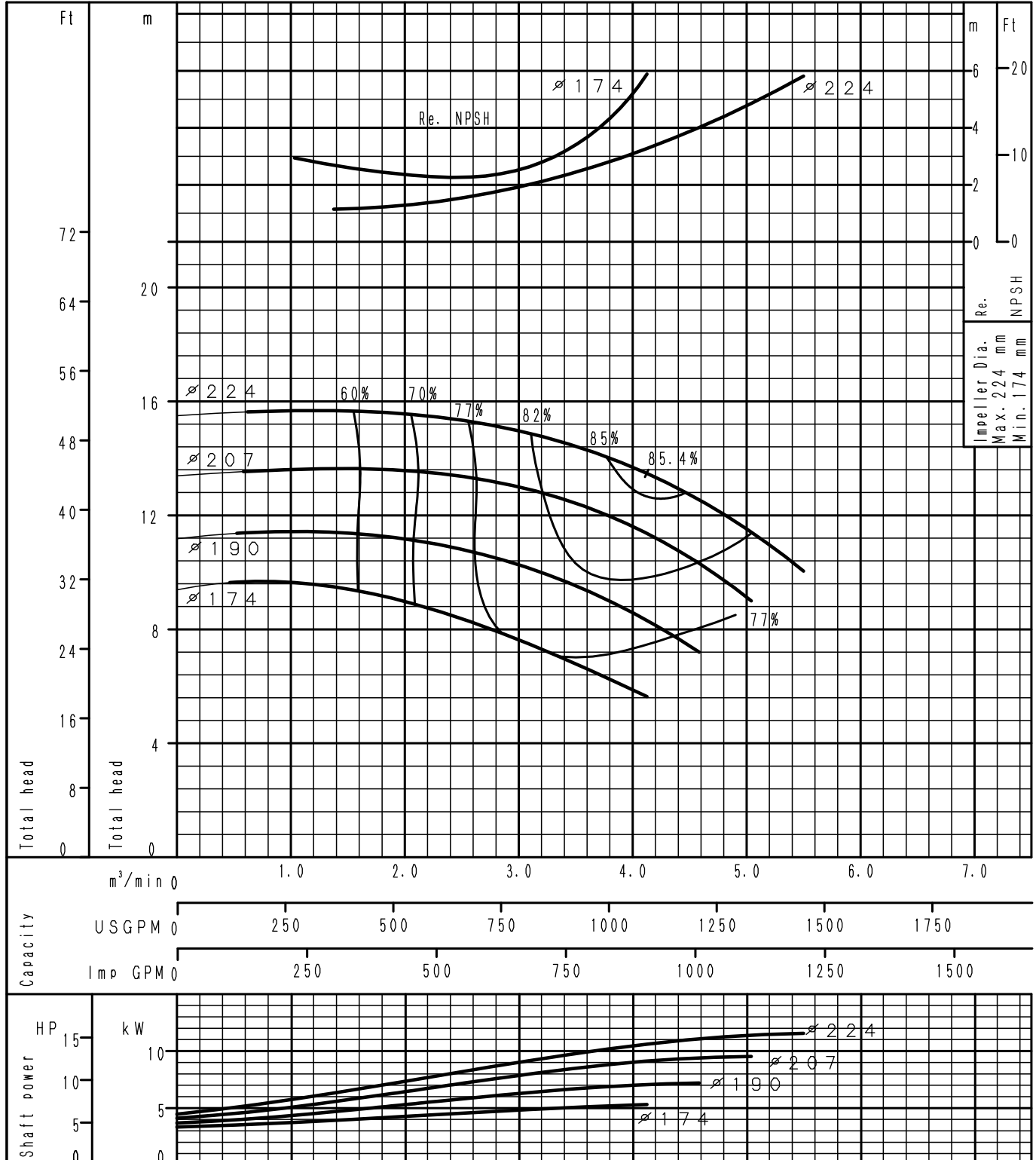

Performance Curve

4 Poles

GS125-250	According to ISO testing code 9906 Grade 3B
50Hz ( Speed 1450 min <sup>-1</sup> )	DENSITY= 1.0 kg/l , VISCOSITY= 1.0 mPa·s

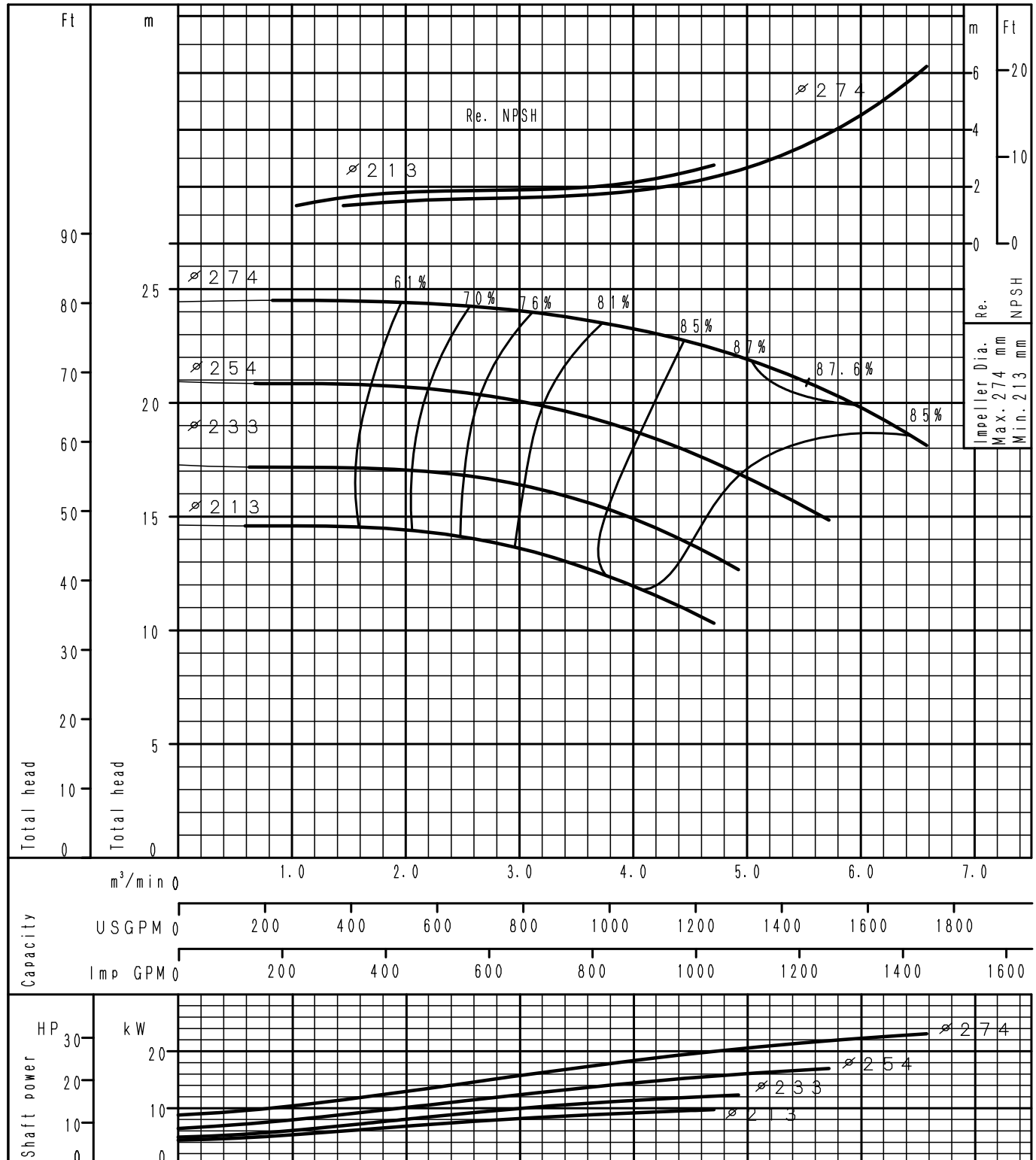

Performance Curve

4 Poles

GS125-315	According to ISO testing code 9906 Grade 3B
50Hz ( Speed 1450 min <sup>-1</sup> )	DENSITY= 1.0 kg/l , VISCOSITY= 1.0 mPa·s

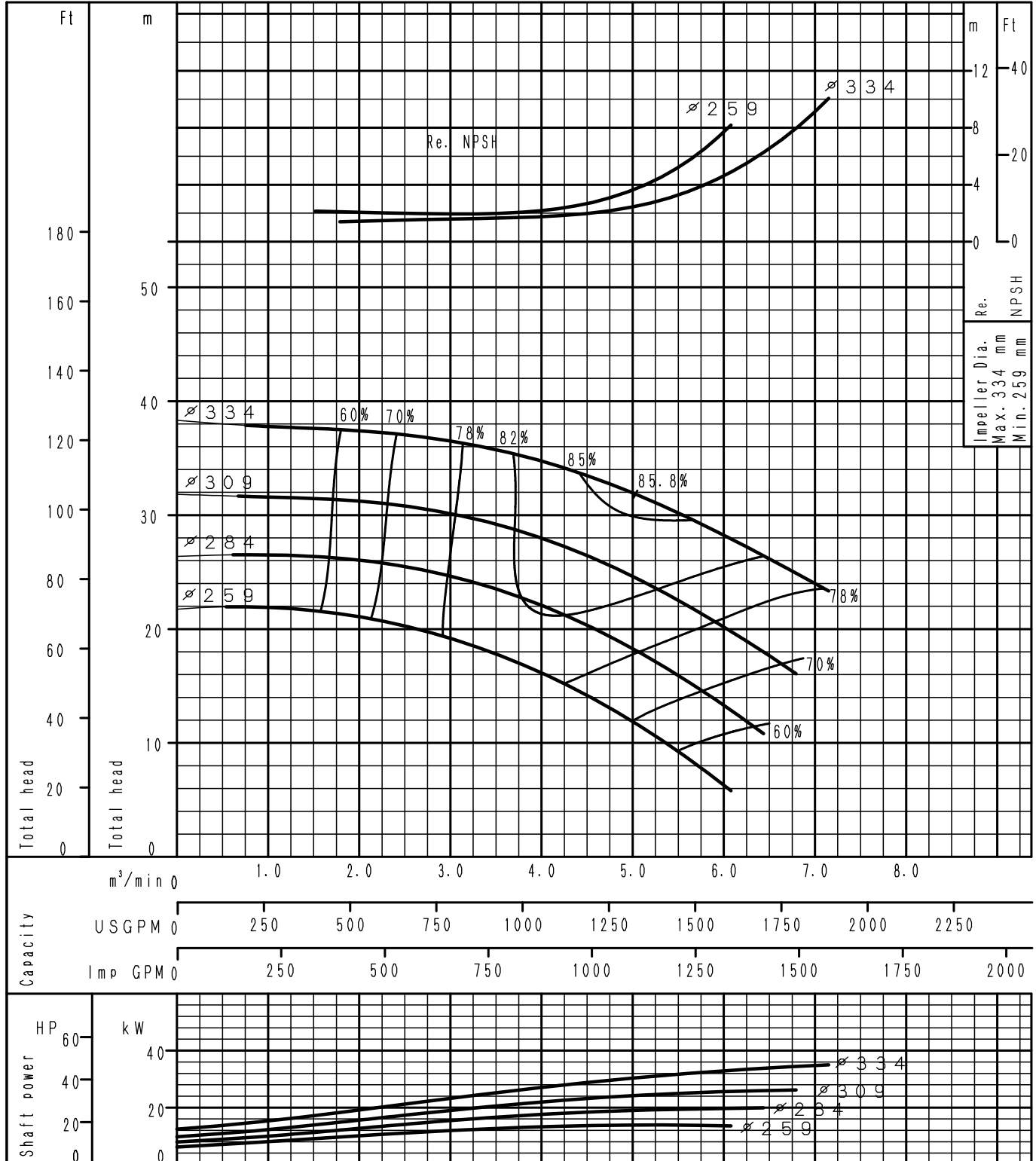

Performance Curve

4 Poles

GS125-400	According to ISO testing code 9906 Grade 3B
50Hz ( Speed 1450 min <sup>-1</sup> )	DENSITY= 1.0 kg/l , VISCOSITY= 1.0 mPa·s

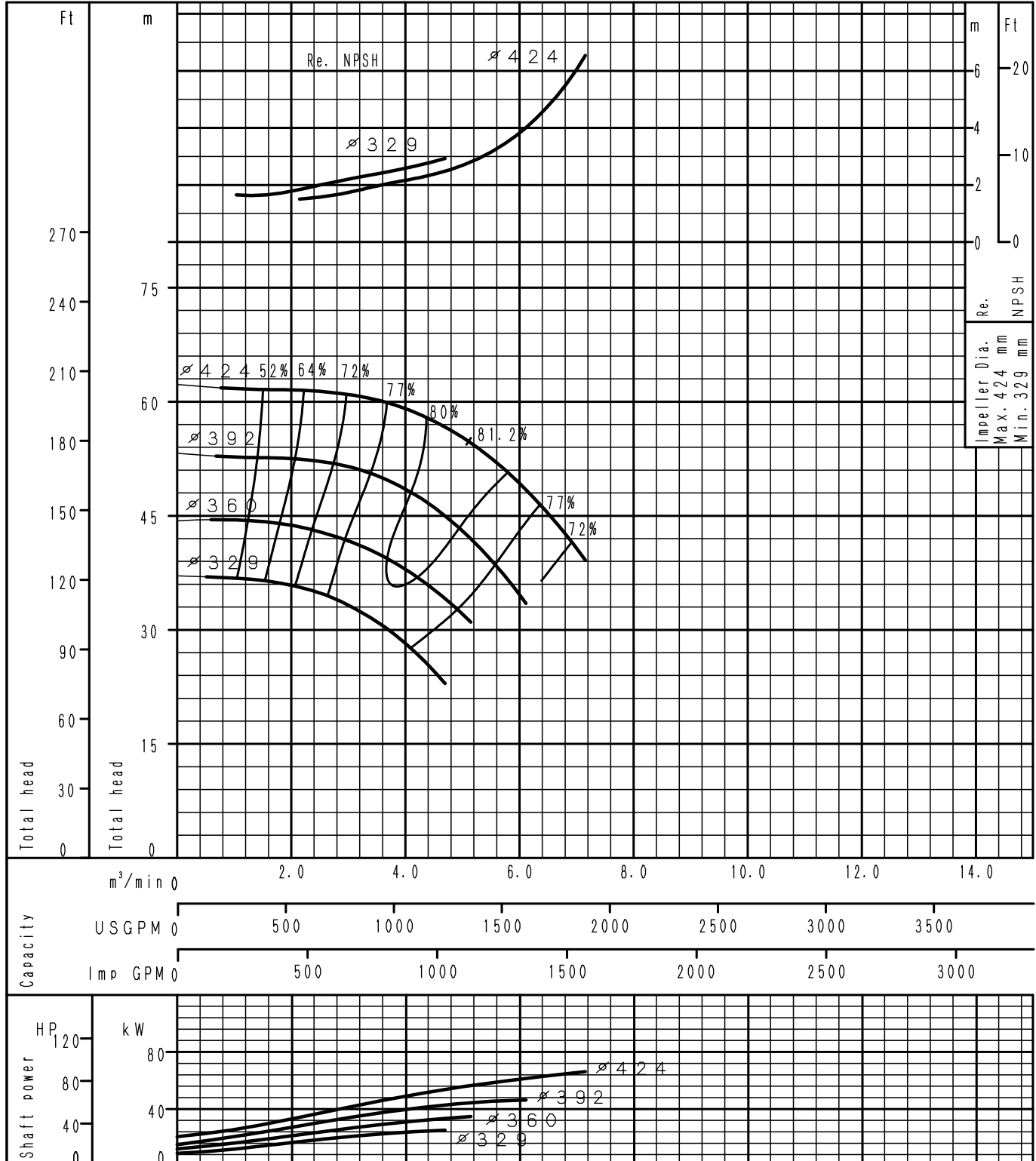

Performance Curve

4 Poles

GS125-500	According to ISO testing code 9906 Grade 3B
50Hz ( Speed 1450 min <sup>-1</sup> )	DENSITY= 1.0 kg/l , VISCOSITY= 1.0 mPa·s

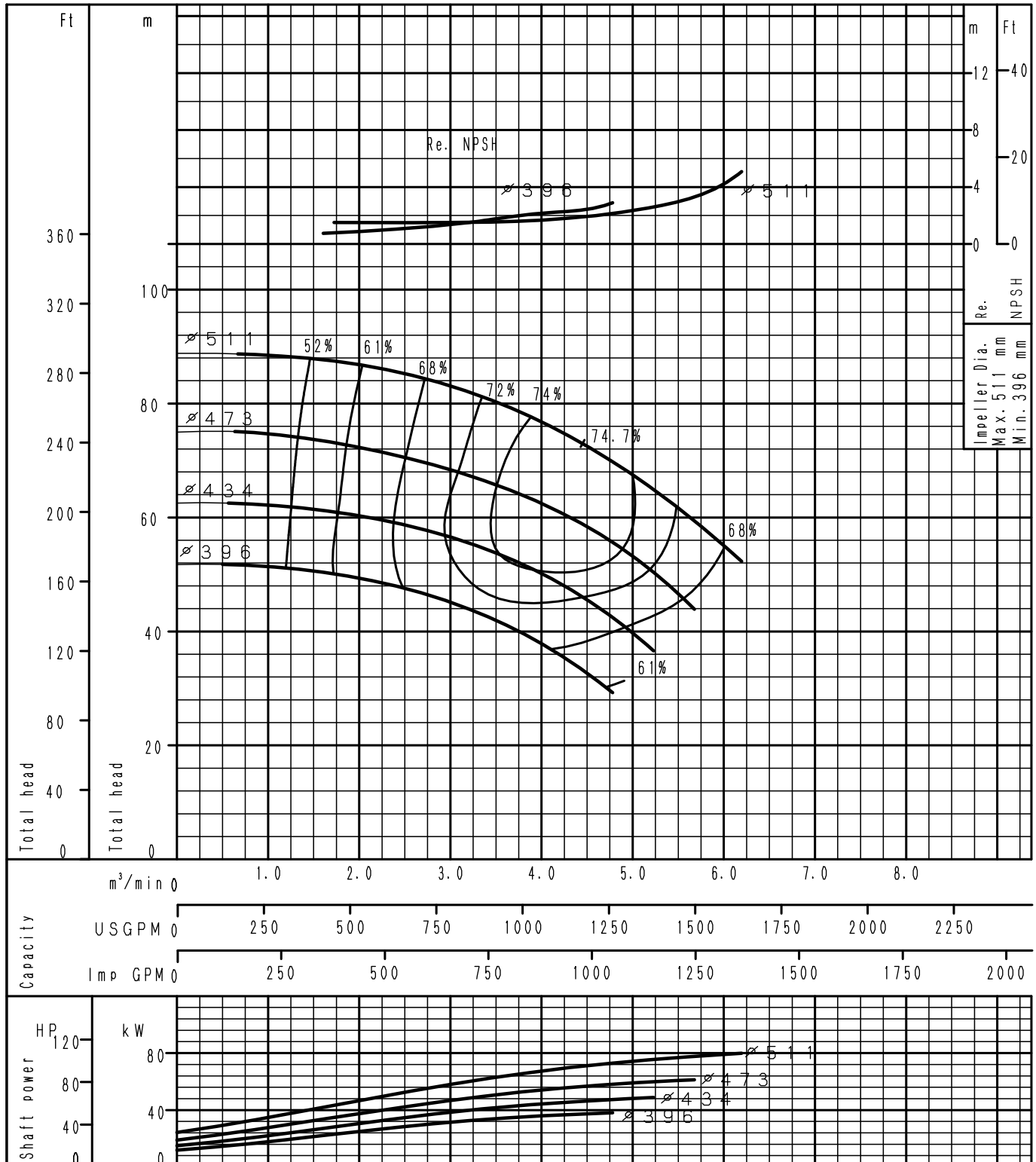

Performance Curve

4 Poles

GS150-200	According to ISO testing code 9906 Grade 3B
50Hz ( Speed 1450 min <sup>-1</sup> )	DENSITY= 1.0 kg/l , VISCOSITY= 1.0 mPa·s

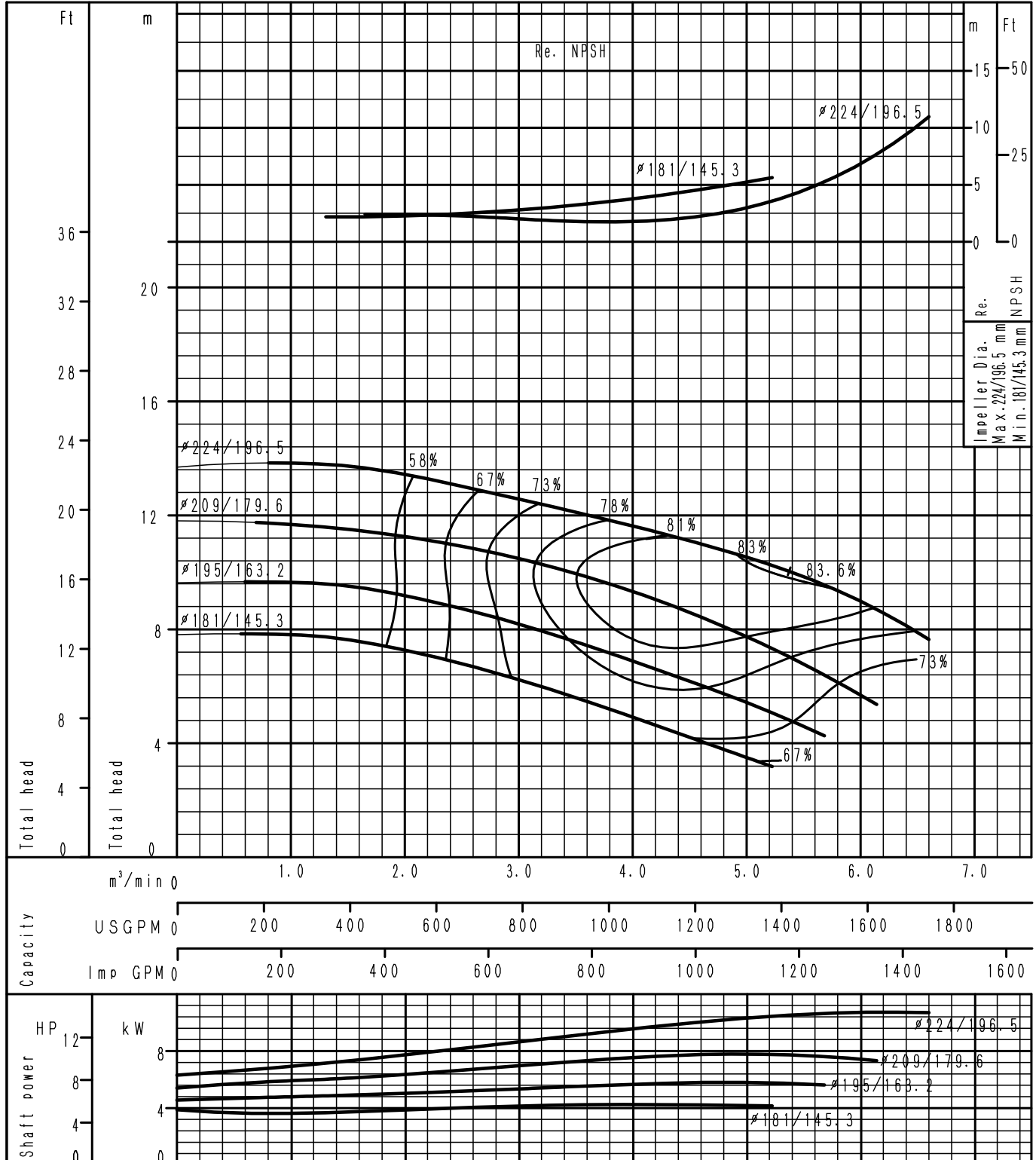

Performance Curve

4 Poles

GS150-250	According to ISO testing code 9906 Grade 3B
50Hz ( Speed 1450 min <sup>-1</sup> )	DENSITY= 1.0 kg/l , VISCOSITY= 1.0 mPa·s

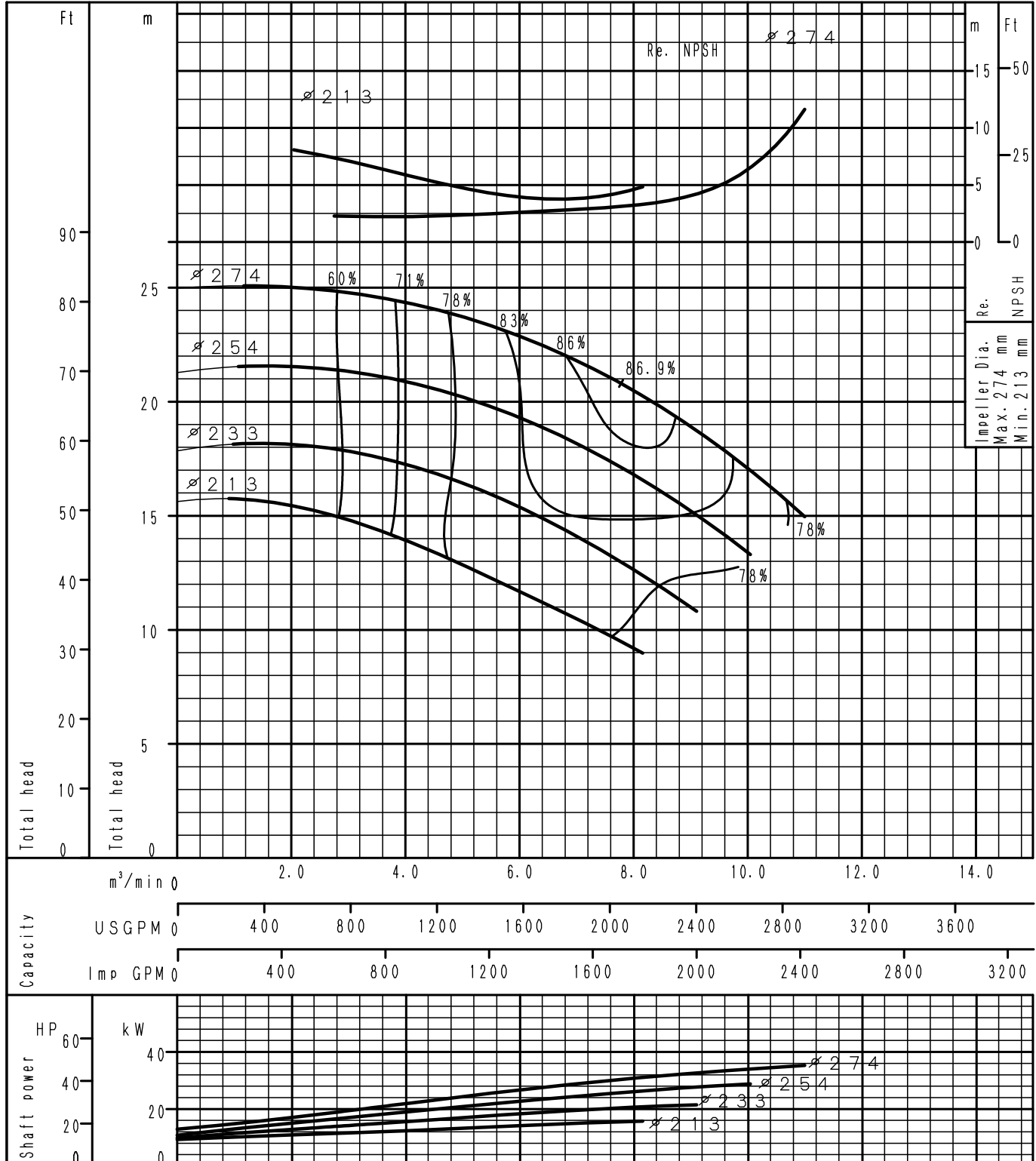

Performance Curve

4 Poles

GS150-315	According to ISO testing code 9906 Grade 3B
50Hz ( Speed 1450 min <sup>-1</sup> )	DENSITY= 1.0 kg/l , VISCOSITY= 1.0 mPa·s

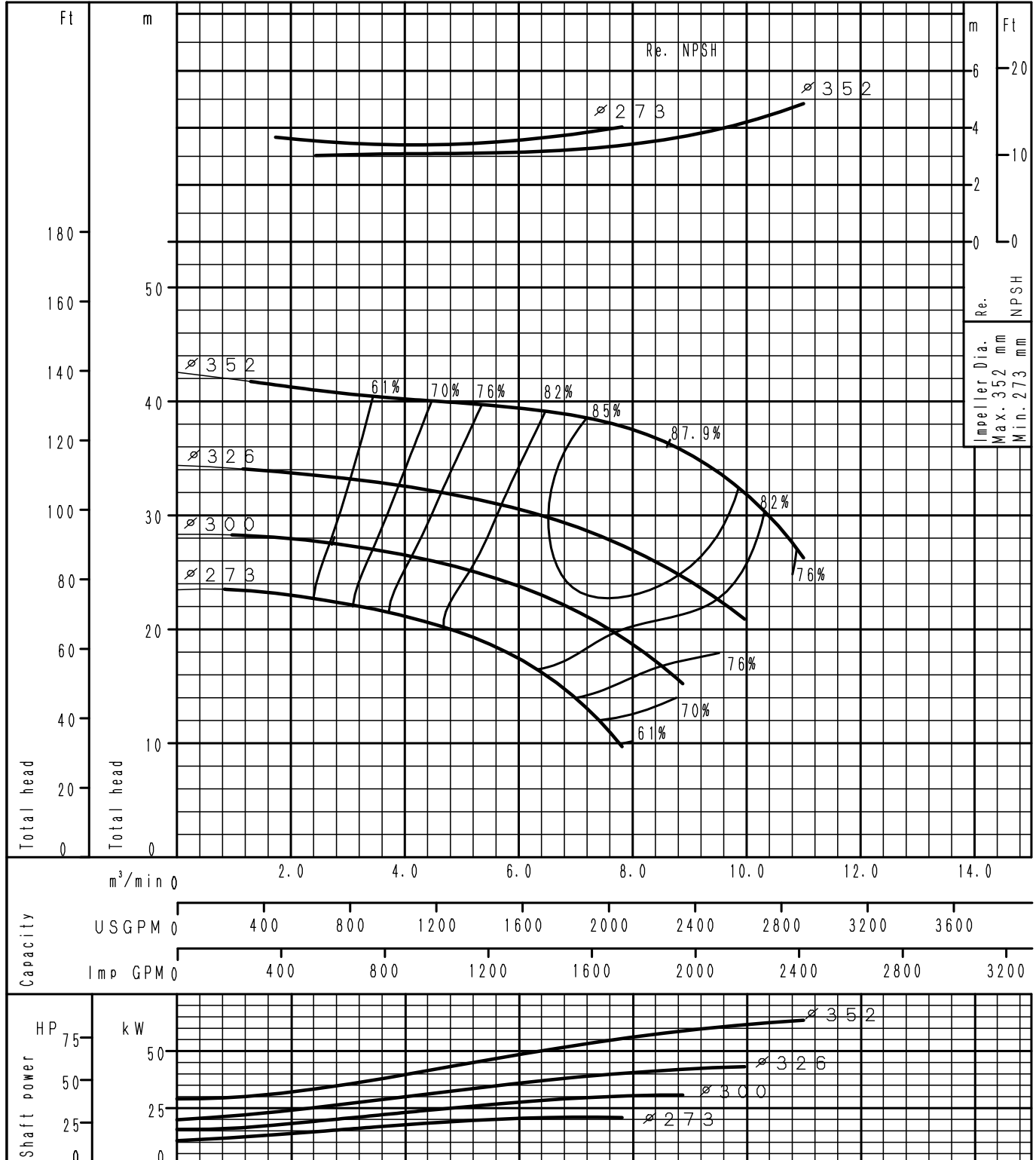



Performance Curve

4 Poles

GS150-400	According to ISO testing code 9906 Grade 3B
50Hz ( Speed 1450 min <sup>-1</sup> )	DENSITY= 1.0 kg/l , VISCOSITY= 1.0 mPa·s

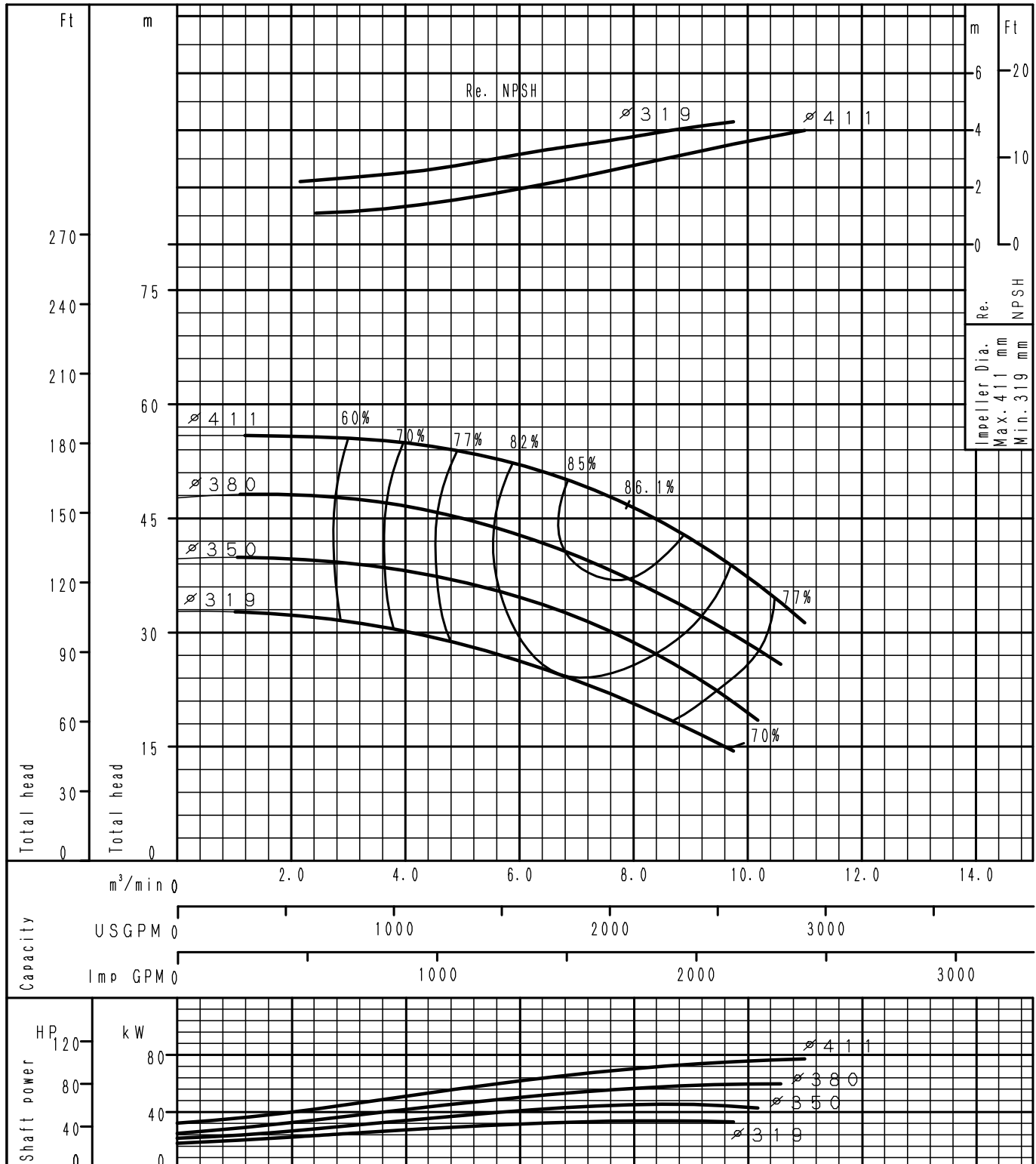

Performance Curve

4 Poles

GS150-500	According to ISO testing code 9906 Grade 3B
50Hz ( Speed 1450 min <sup>-1</sup> )	DENSITY= 1.0 kg/l , VISCOSITY= 1.0 mPa·s

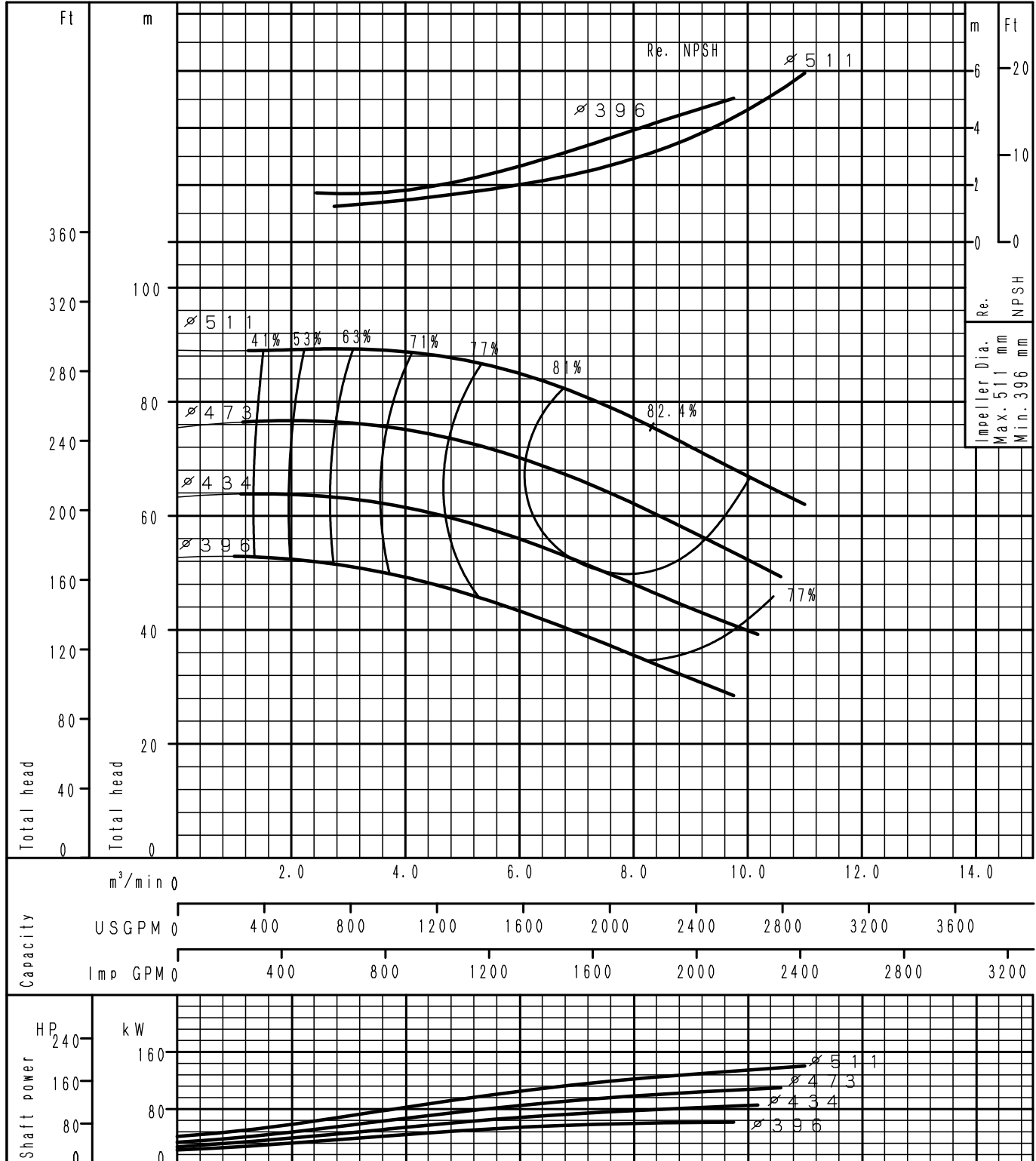

Performance Curve

4 Poles

GS200-400	According to ISO testing code 9906 Grade 3B
50Hz ( Speed 1450 min <sup>-1</sup> )	DENSITY= 1.0 kg/l , VISCOSITY= 1.0 mPa·s

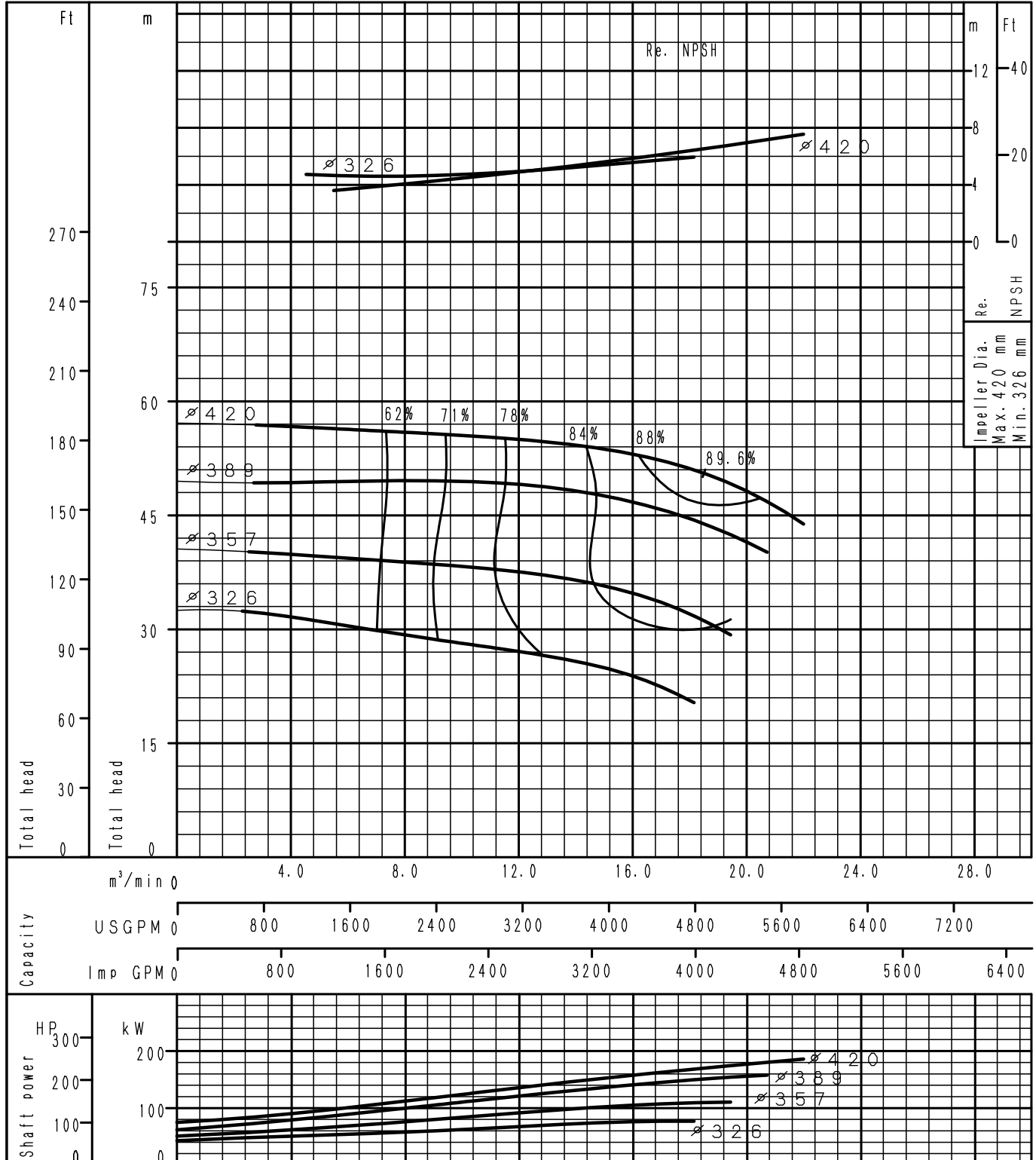

Performance Curve

4 Poles

GS200-500	According to ISO testing code 9906 Grade 3B
50Hz ( Speed 1450 min <sup>-1</sup> )	DENSITY= 1.0 kg/l , VISCOSITY= 1.0 mPa·s

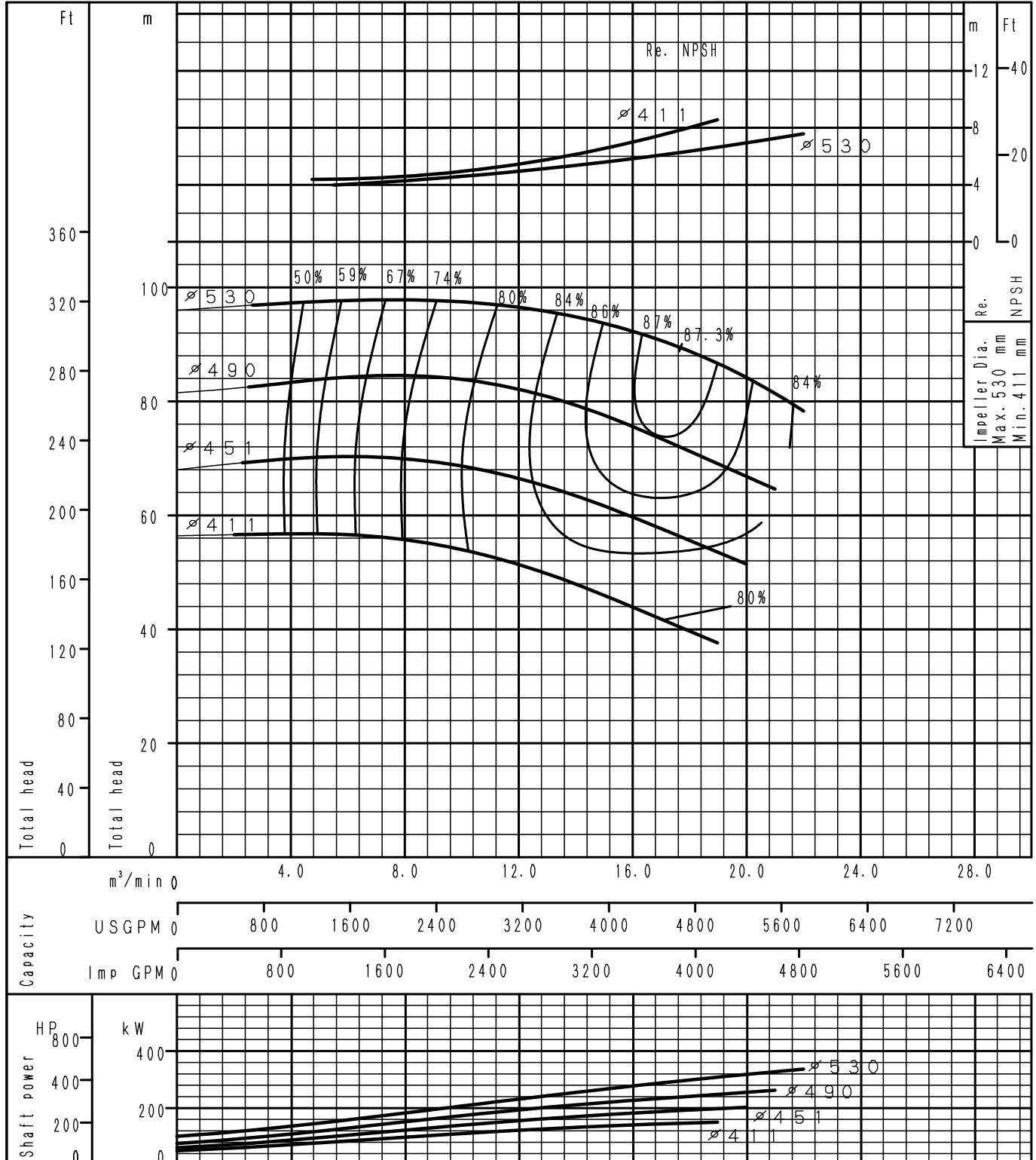

Performance Curve

2 Poles

GS32-125.1	According to ISO testing code 9906 Grade 3B
60Hz ( Speed 3500 min <sup>-1</sup> )	DENSITY= 1.0 kg/l , VISCOSITY= 1.0 mPa·s

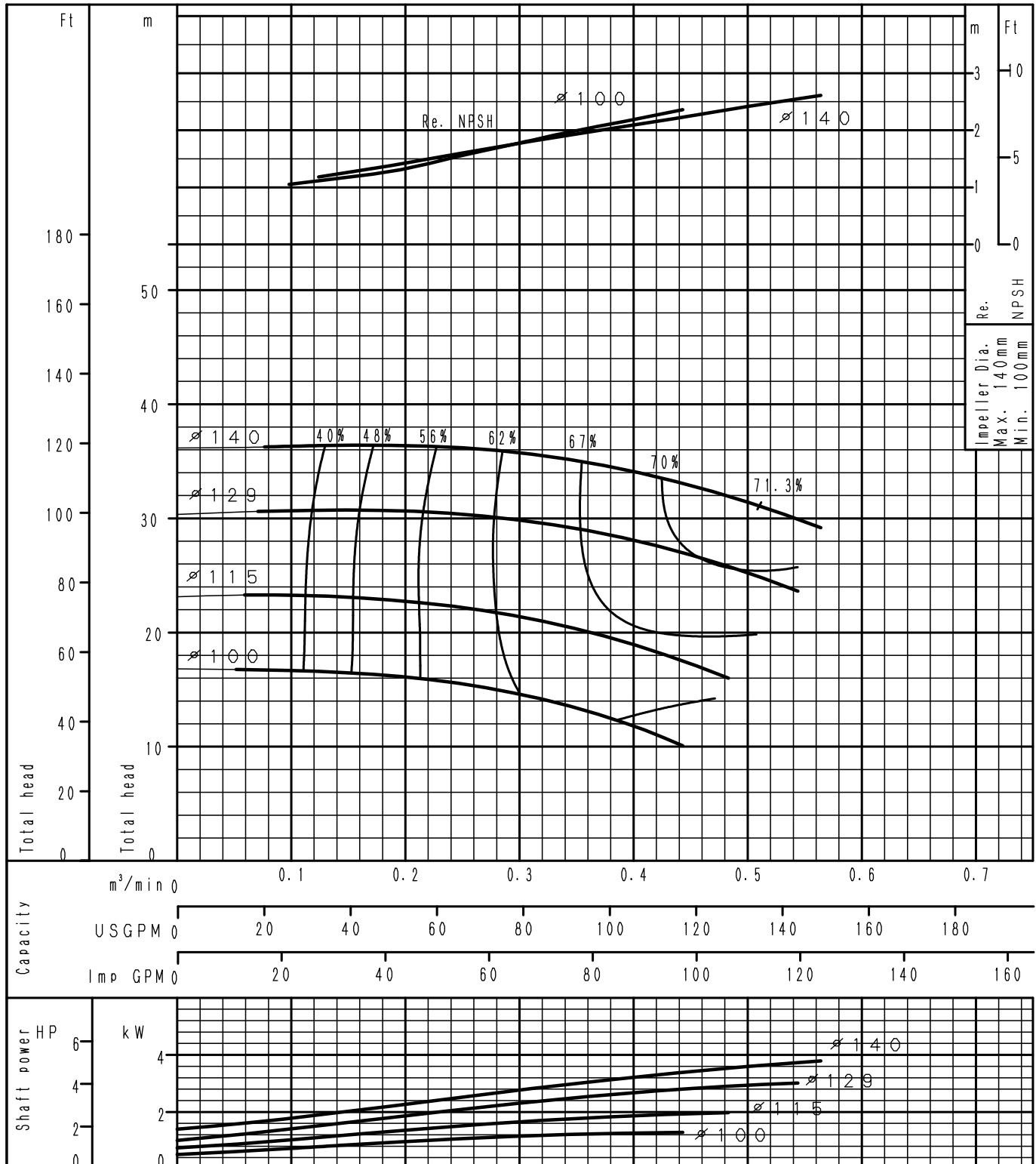

Performance Curve

2 Poles

GS32-160.1	According to ISO testing code 9906 Grade 3B
60Hz ( Speed 3500 min <sup>-1</sup> )	DENSITY= 1.0 kg/l , VISCOSITY= 1.0 mPa·s

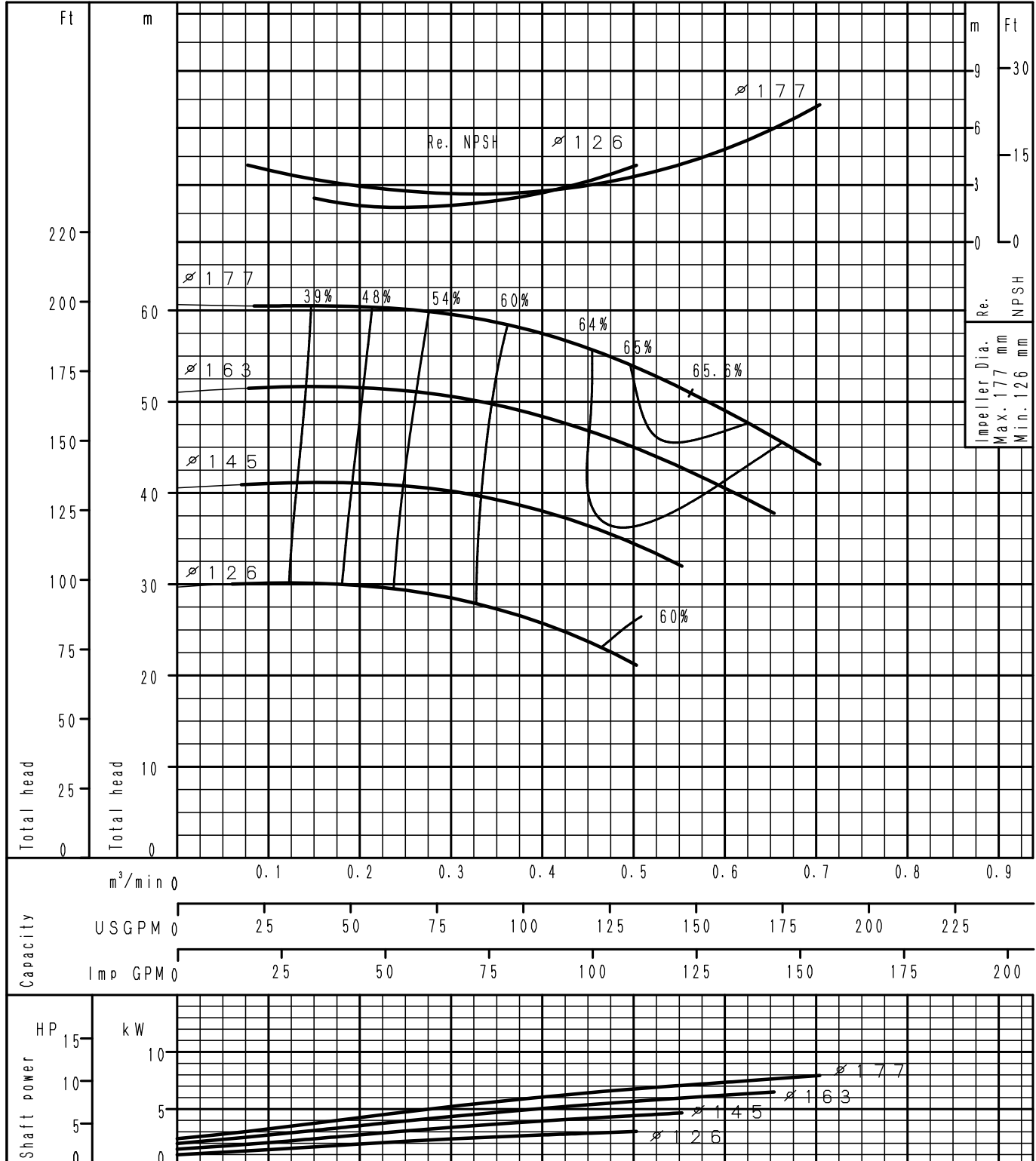

Performance Curve

2 Poles

GS32-200.1	According to ISO testing code 9906 Grade 3B
60Hz ( Speed 3500 min <sup>-1</sup> )	DENSITY= 1.0 kg/l , VISCOSITY= 1.0 mPa·s

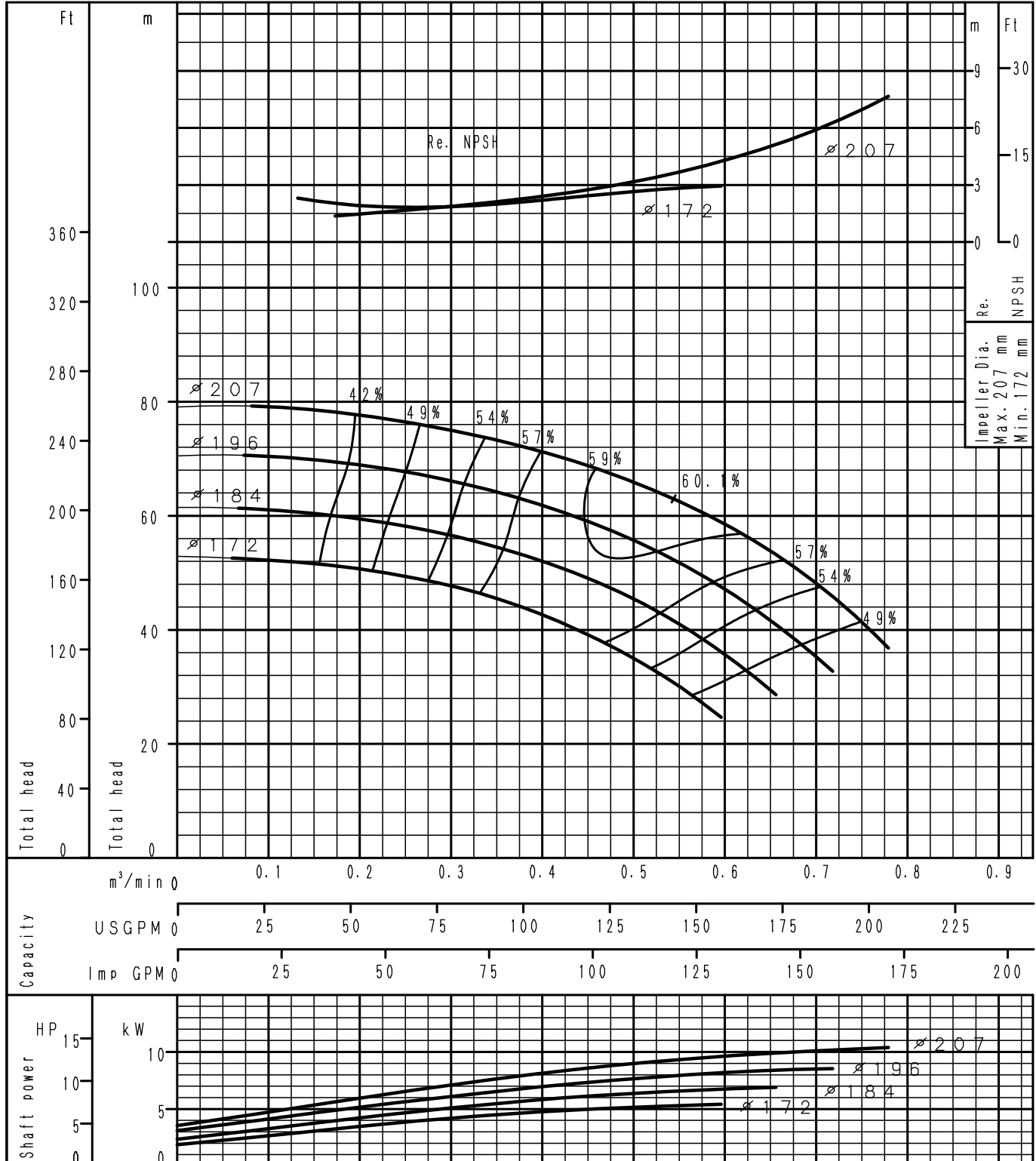

Performance Curve

2 Poles

GS32-125	According to ISO testing code 9906 Grade 3B
60Hz ( Speed 3500 min <sup>-1</sup> )	DENSITY= 1.0 kg/l , VISCOSITY= 1.0 mPa·s

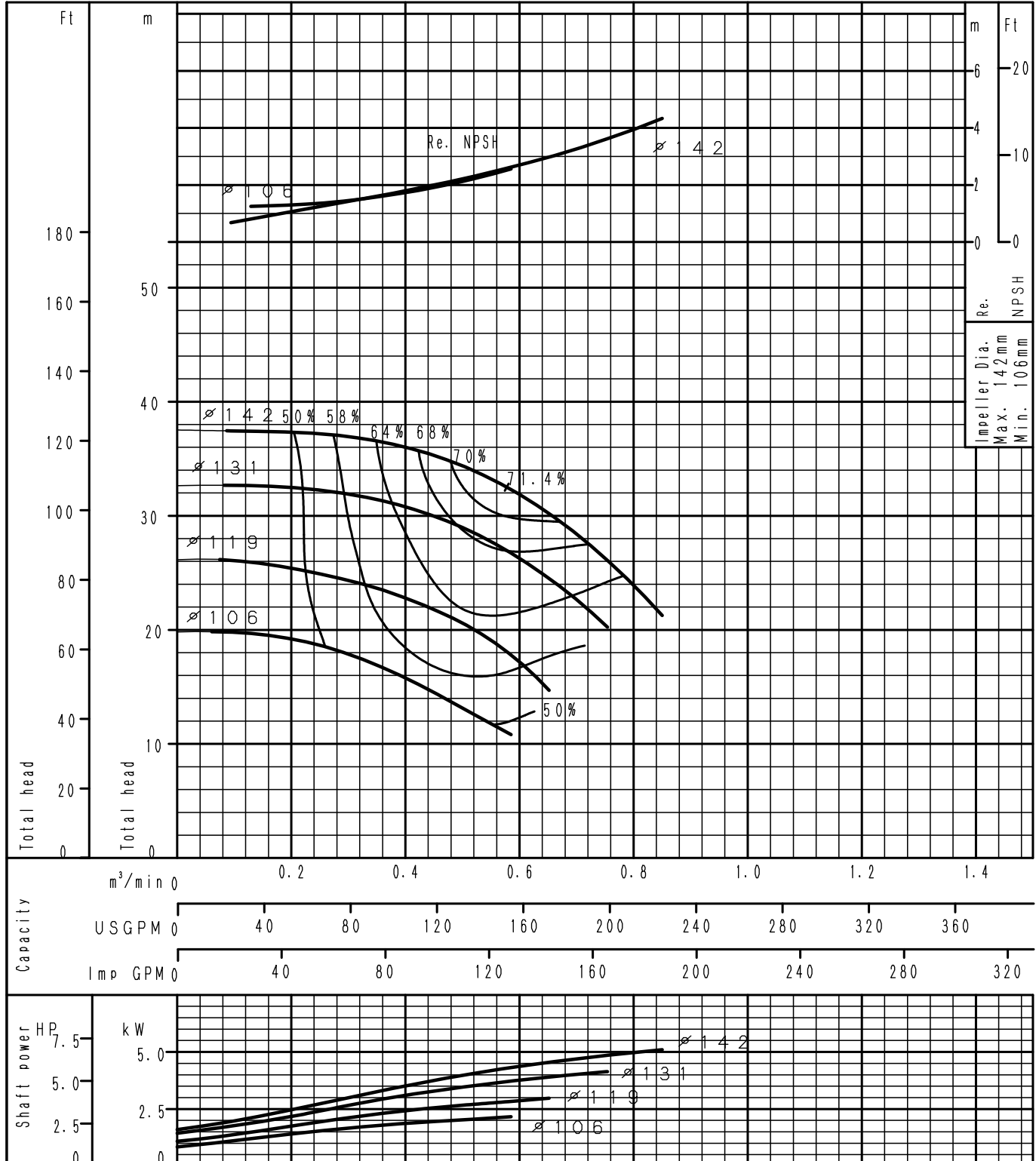



Performance Curve

2 Poles

GS32-160	According to ISO testing code 9906 Grade 3B
60Hz ( Speed 3500 min <sup>-1</sup> )	DENSITY= 1.0 kg/l , VISCOSITY= 1.0 mPa·s

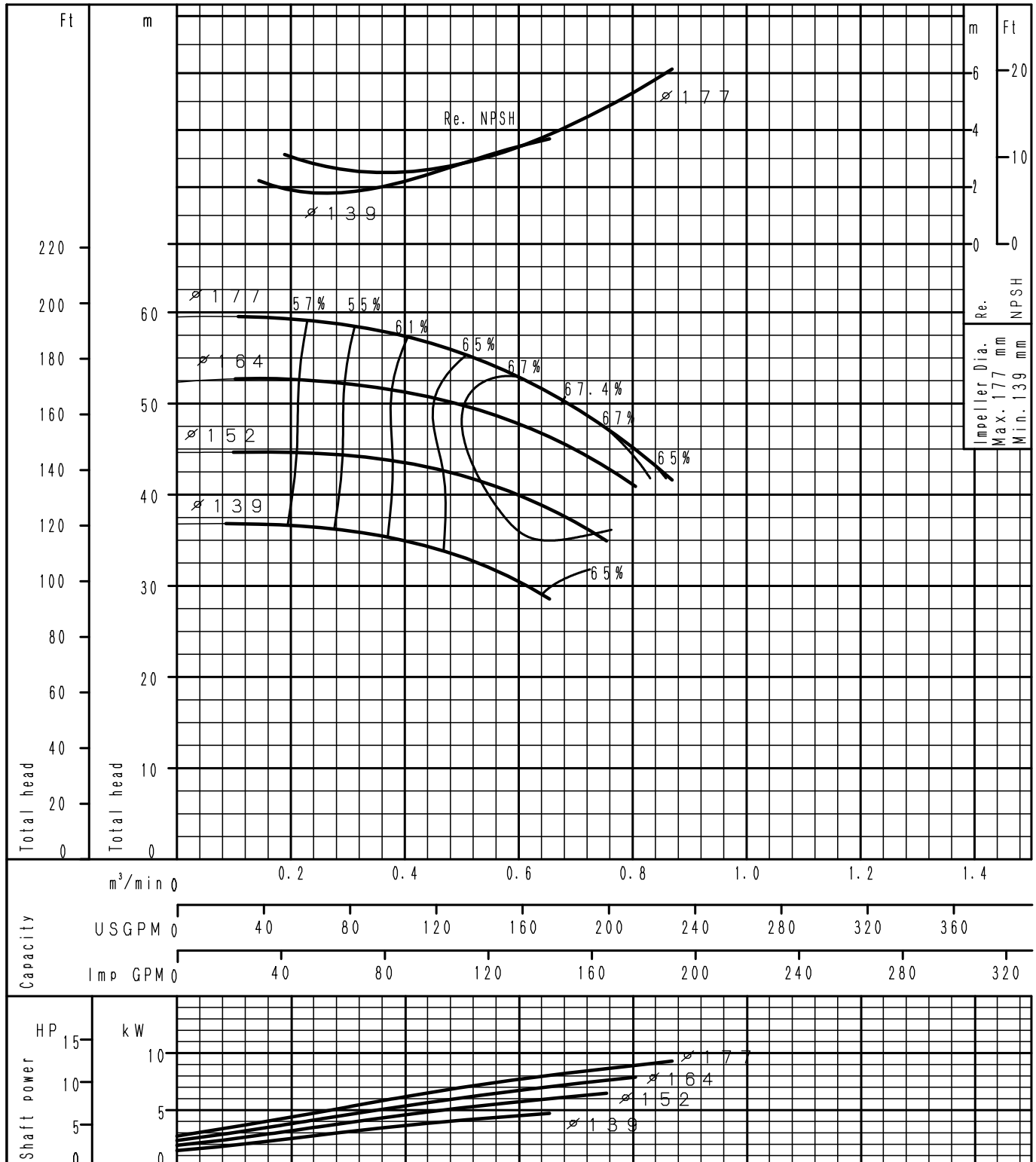

Performance Curve

2 Poles

GS32-200	According to ISO testing code 9906 Grade 3B
60Hz ( Speed 3500 min <sup>-1</sup> )	DENSITY= 1.0 kg/l , VISCOSITY= 1.0 mPa·s

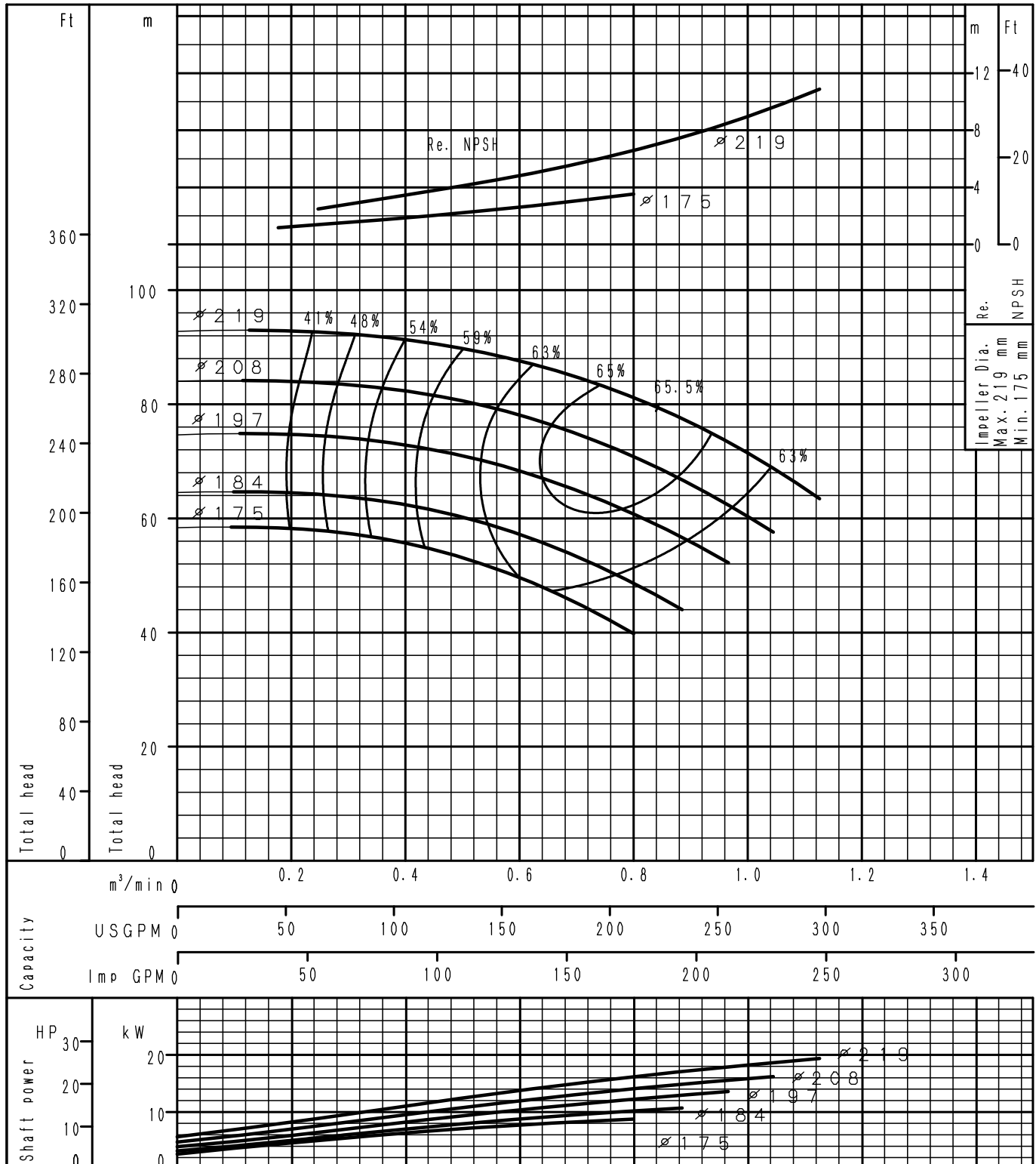

Performance Curve

2 Poles

<h1 style="margin: 0;">GS32-250</h1>	According to ISO testing code 9906 Grade 3B
60Hz ( Speed 3500 min <sup>-1</sup> )	DENSITY= 1.0 kg/l , VISCOSITY= 1.0 mPa·s

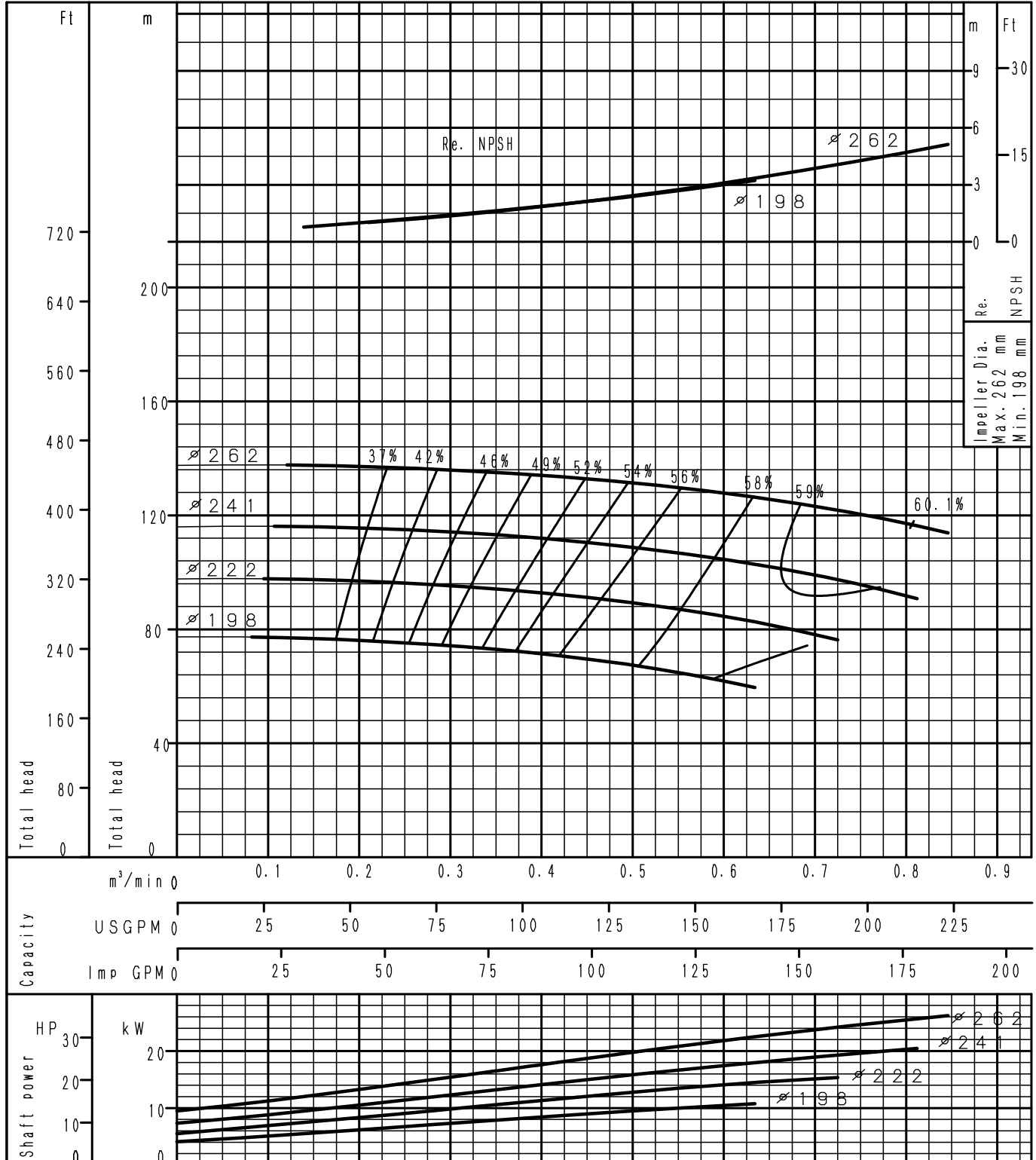

Performance Curve

2 Poles

GS40-125	According to ISO testing code 9906 Grade 3B
60Hz ( Speed 3500 min <sup>-1</sup> )	DENSITY= 1.0 kg/l , VISCOSITY= 1.0 mPa·s

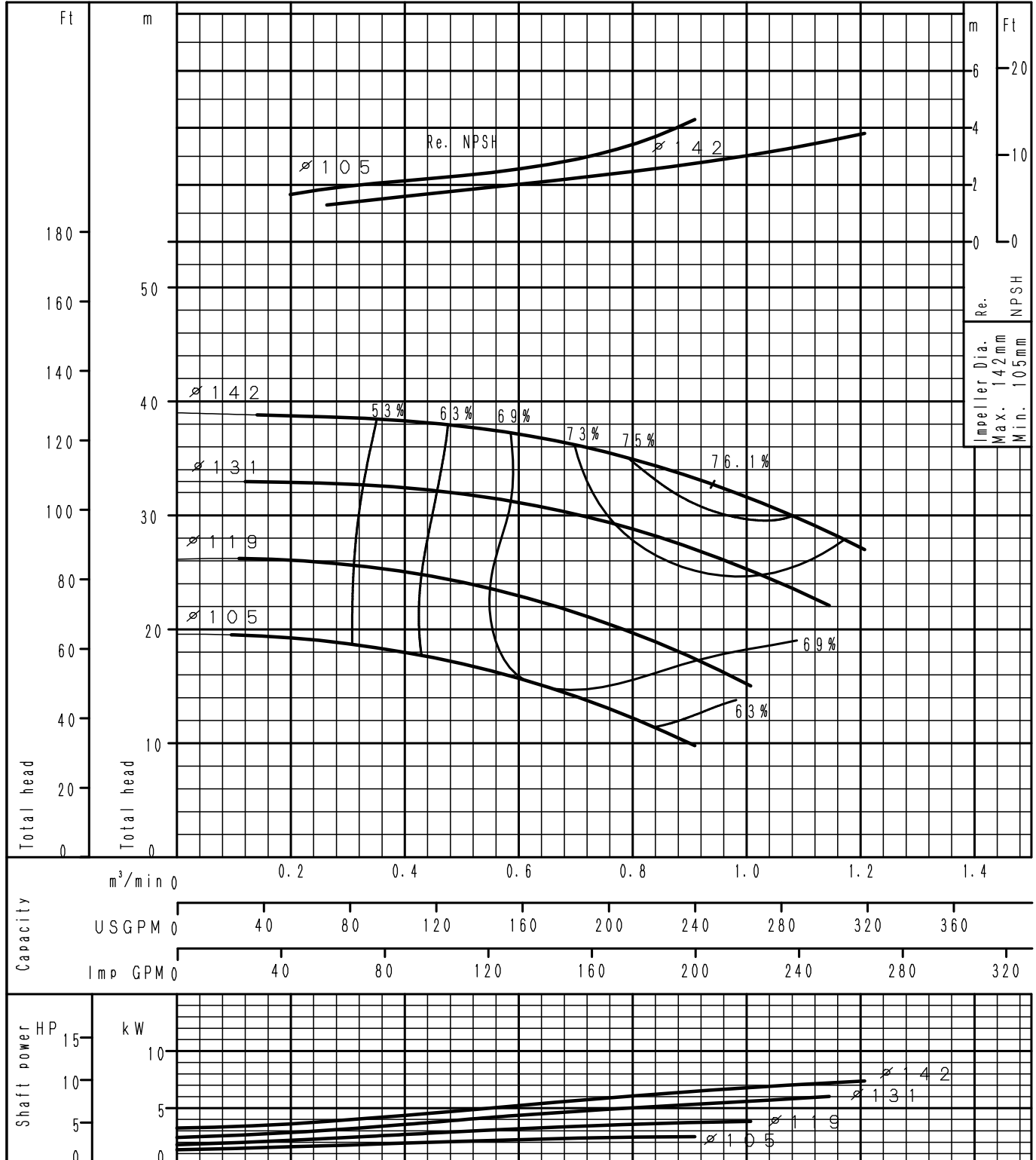

Performance Curve

2 Poles

GS40-160	According to ISO testing code 9906 Grade 3B
60Hz ( Speed 3500 min <sup>-1</sup> )	
DENSITY= 1.0 kg/l , VISCOSITY= 1.0 mPa·s	

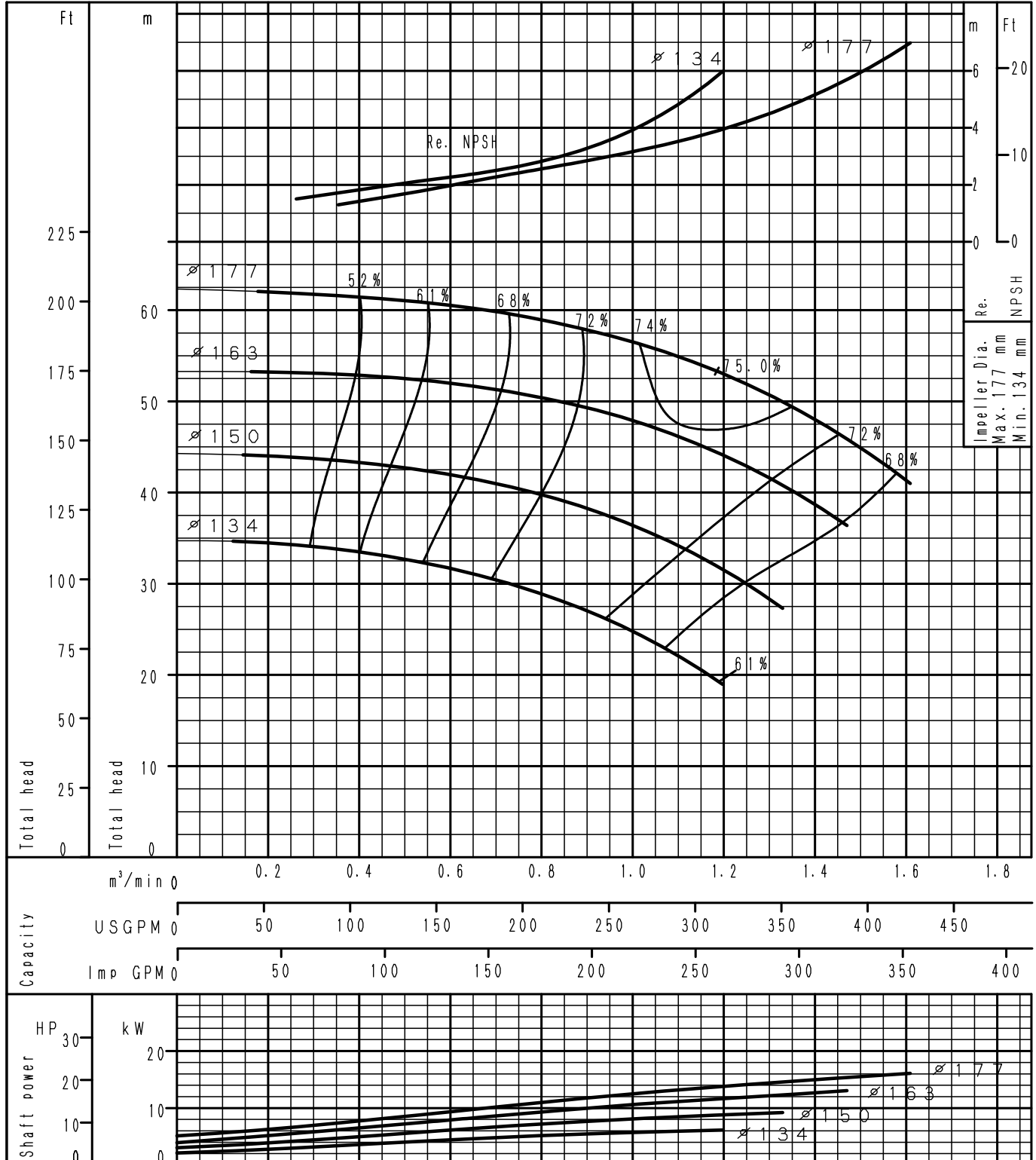

Performance Curve

2 Poles

GS40-200	According to ISO testing code 9906 Grade 3B
60Hz ( Speed 3500 min <sup>-1</sup> )	DENSITY= 1.0 kg/t , VISCOSITY= 1.0 mPa·s

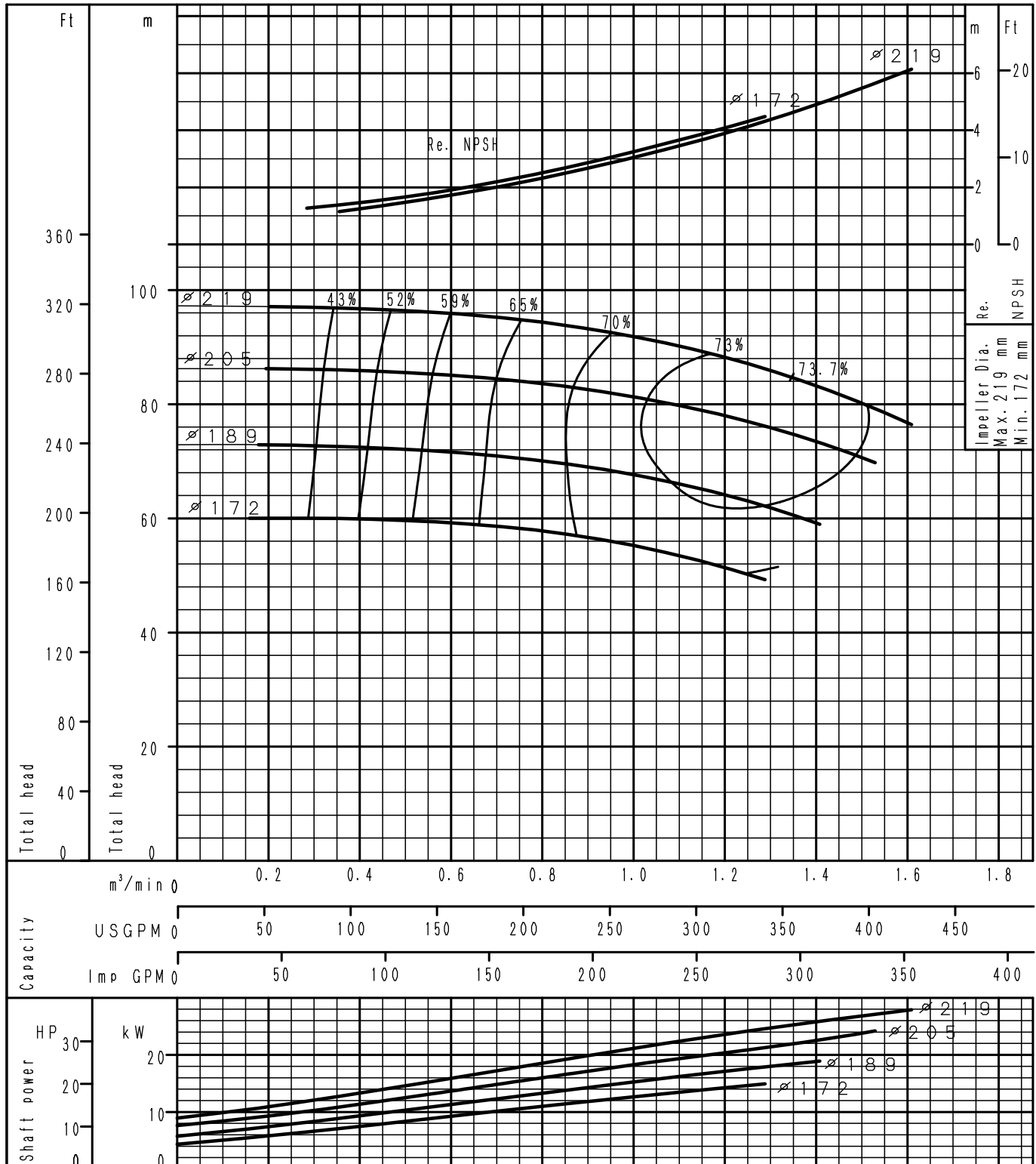

Performance Curve

2 Poles

GS40-250	According to ISO testing code 9906 Grade 3B
60Hz ( Speed 3500 min <sup>-1</sup> )	DENSITY= 1.0 kg/l , VISCOSITY= 1.0 mPa·s

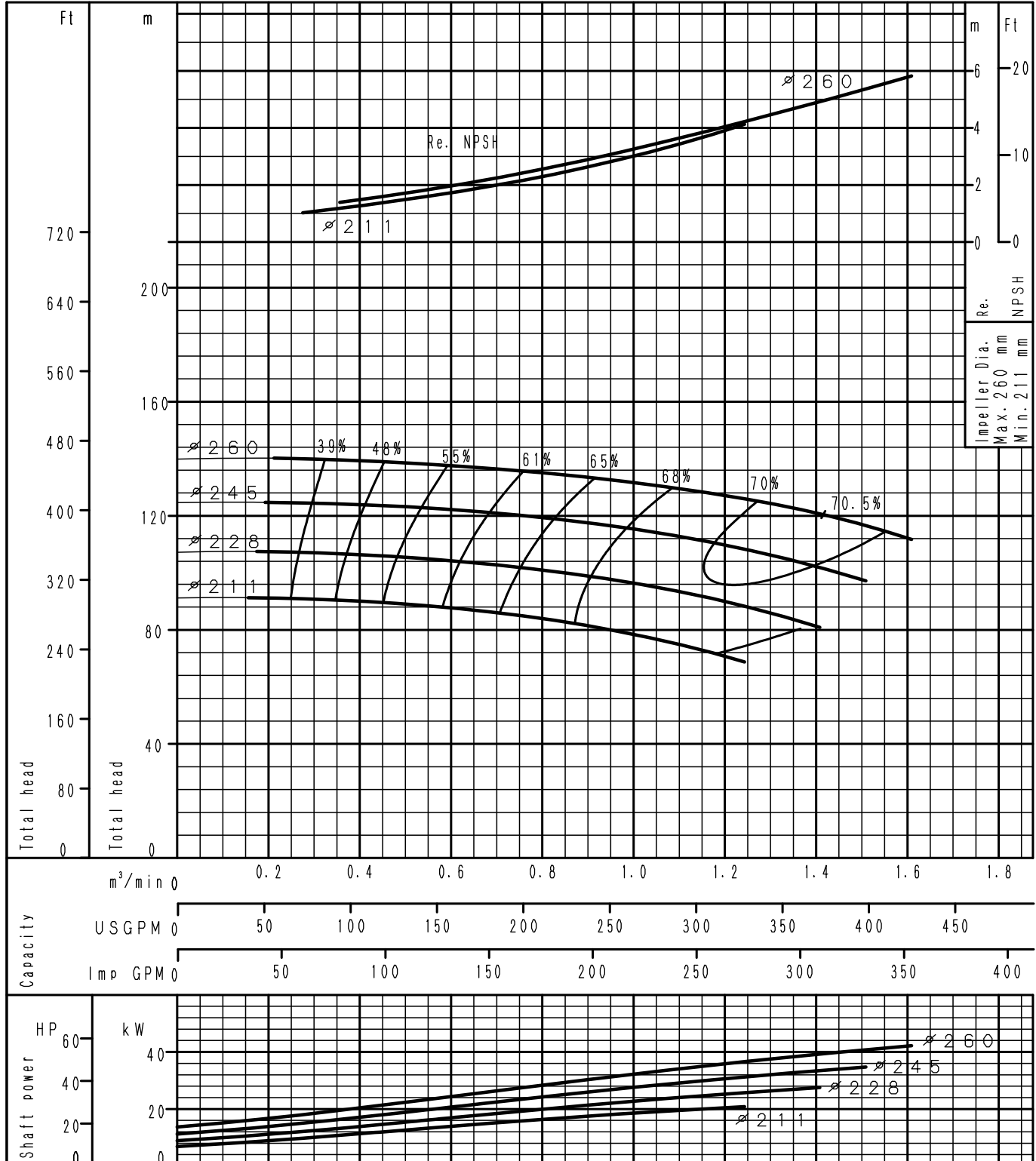

Performance Curve

2 Poles

GS50-125	According to ISO testing code 9906 Grade 3B
60Hz ( Speed 3500 min <sup>-1</sup> )	
DENSITY= 1.0 kg/l , VISCOSITY= 1.0 mPa·s	

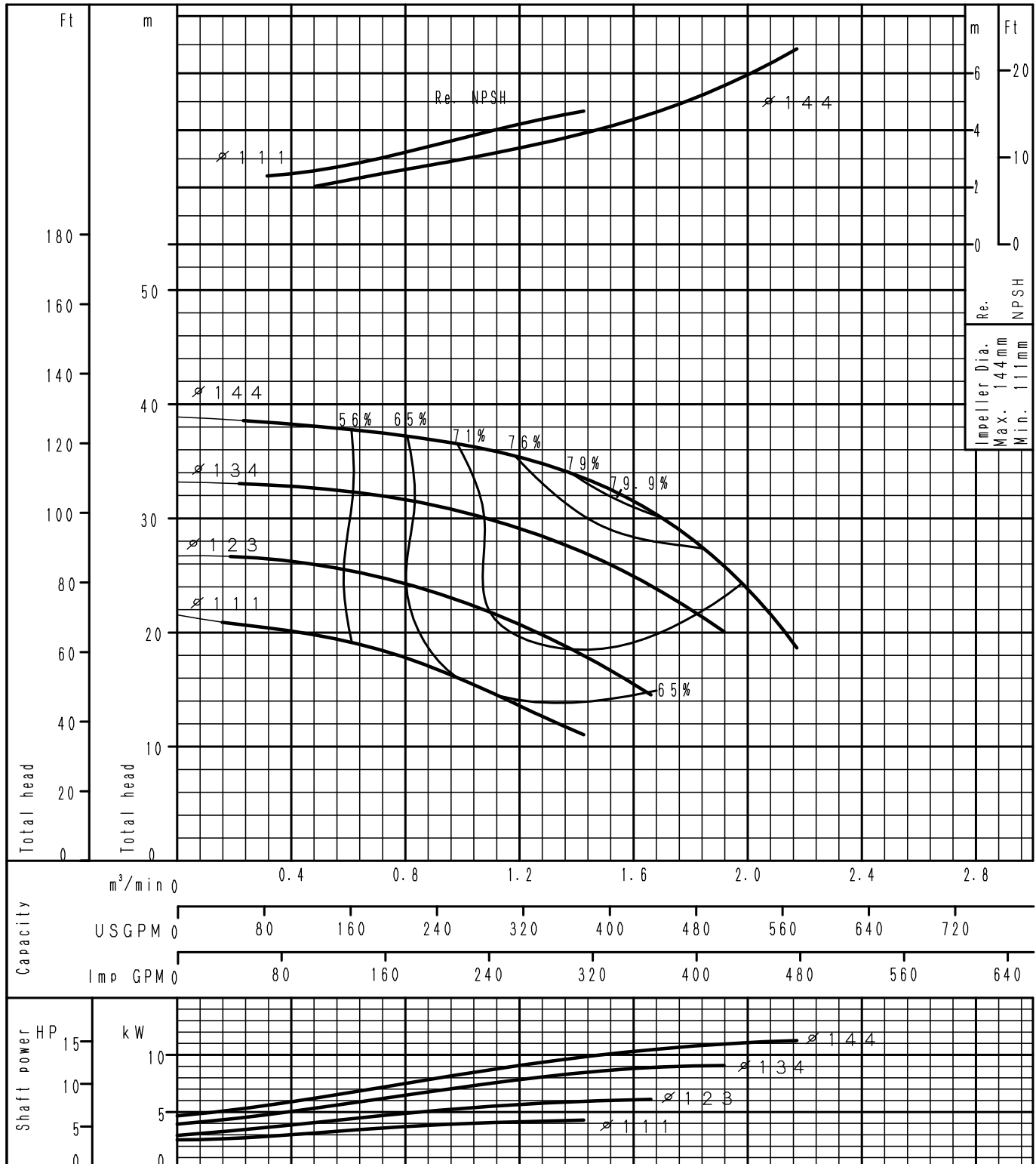



Performance Curve

2 Poles

GS50-160	According to ISO testing code 9906 Grade 3B
60Hz ( Speed 3500 min <sup>-1</sup> )	
DENSITY= 1.0 kg/l , VISCOSITY= 1.0 mPa·s	

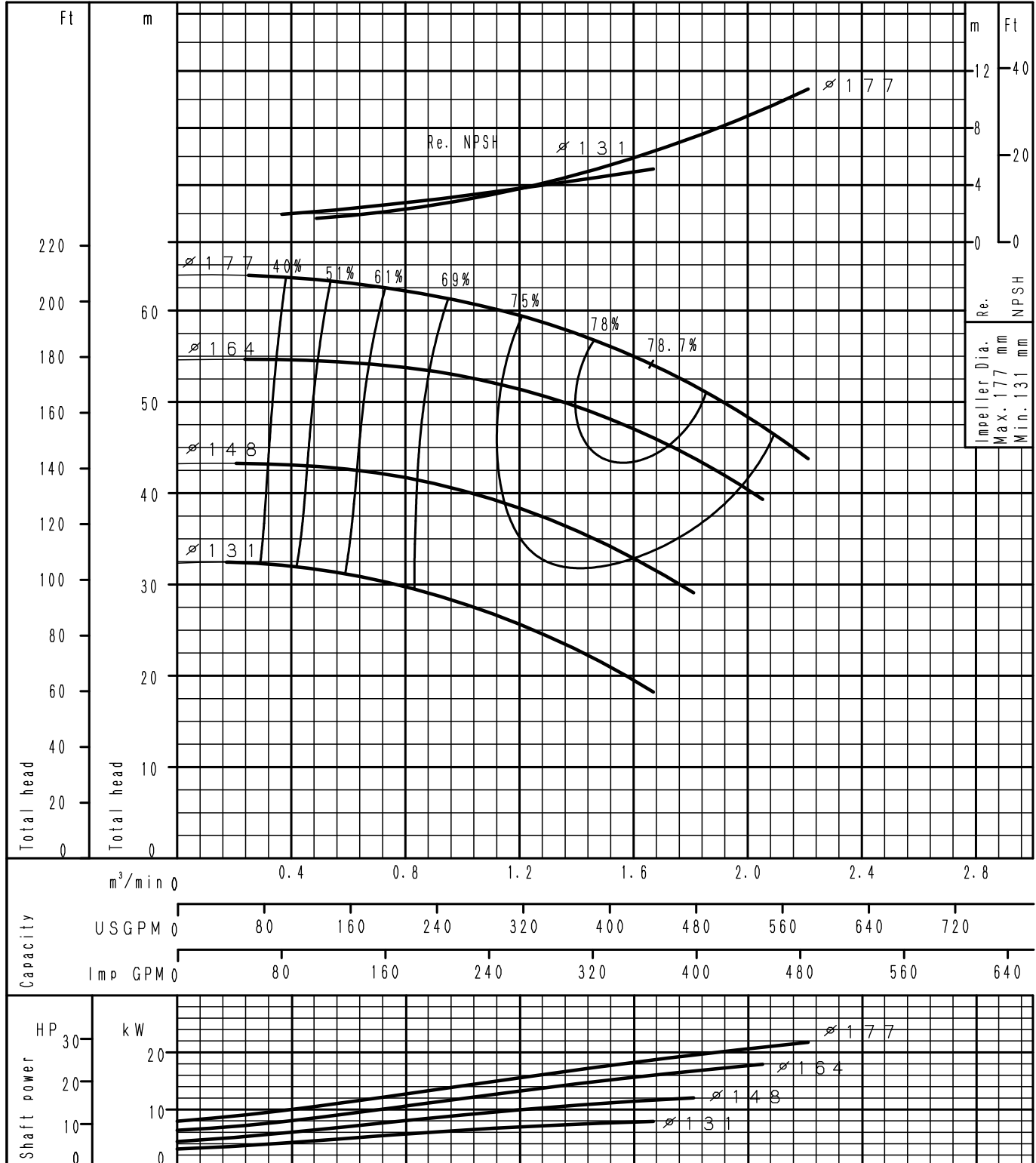

Performance Curve

2 Poles

GS50-200	According to ISO testing code 9906 Grade 3B
60Hz ( Speed 3500 min <sup>-1</sup> )	DENSITY= 1.0 kg/l , VISCOSITY= 1.0 mPa·s

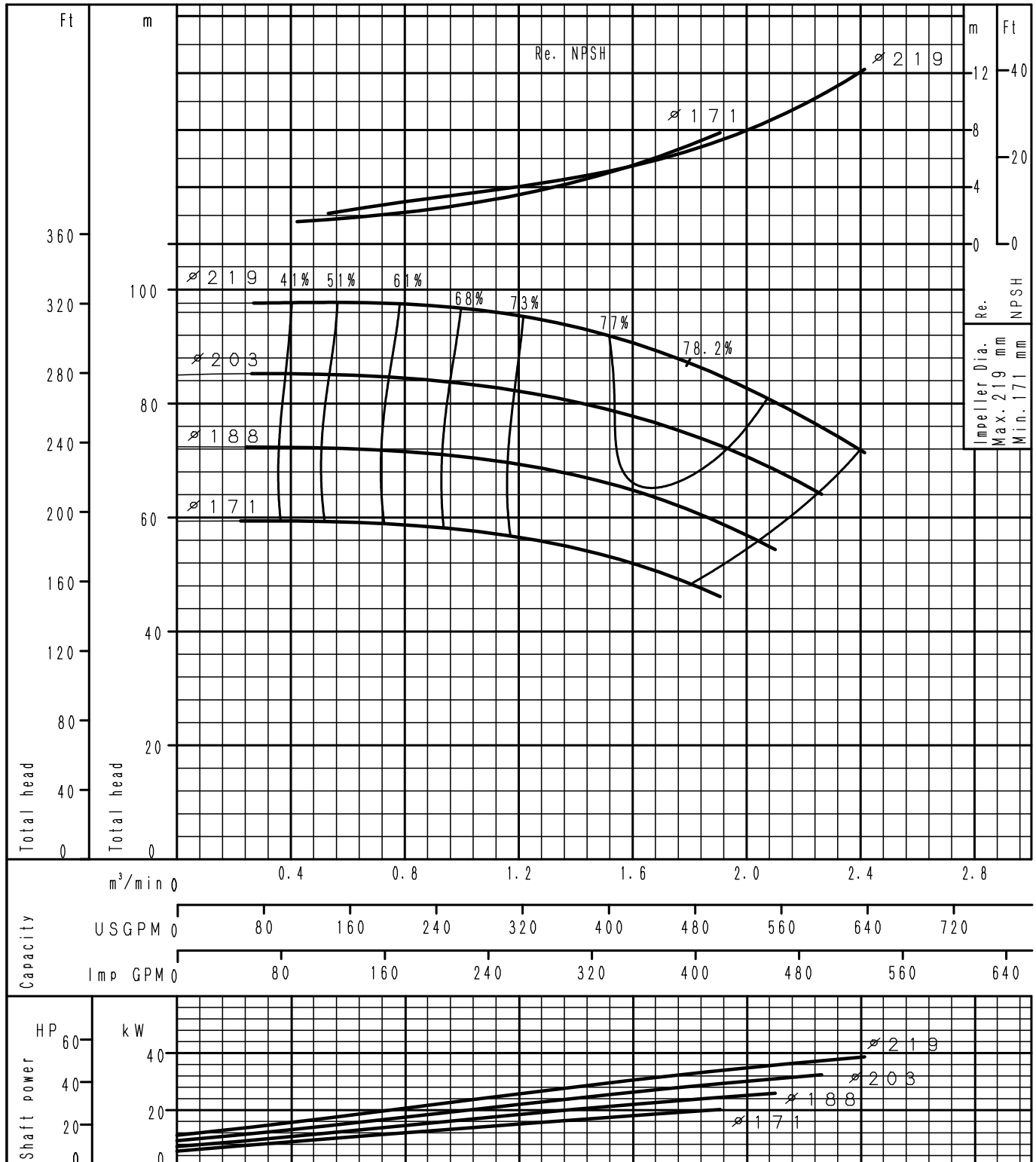

Performance Curve

2 Poles

<h1 style="margin: 0;">GS50-250</h1>	According to ISO testing code 9906 Grade 3B
60Hz ( Speed 3500 min <sup>-1</sup> )	DENSITY= 1.0 kg/l , VISCOSITY= 1.0 mPa·s

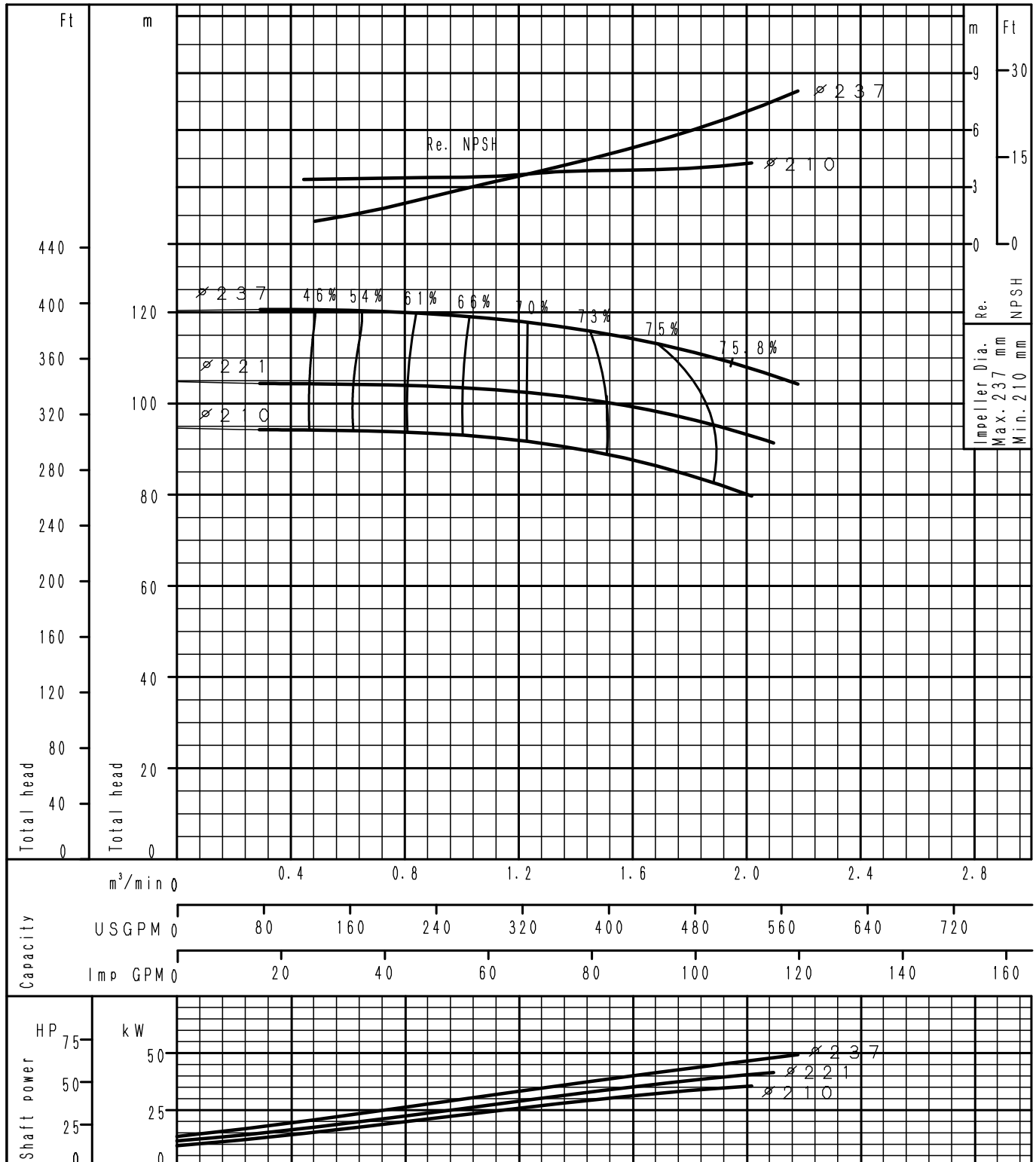

Performance Curve

2 Poles

GS65-125	According to ISO testing code 9906 Grade 3B
60Hz ( Speed 3500 min <sup>-1</sup> )	DENSITY= 1.0 kg/l , VISCOSITY= 1.0 mPa·s

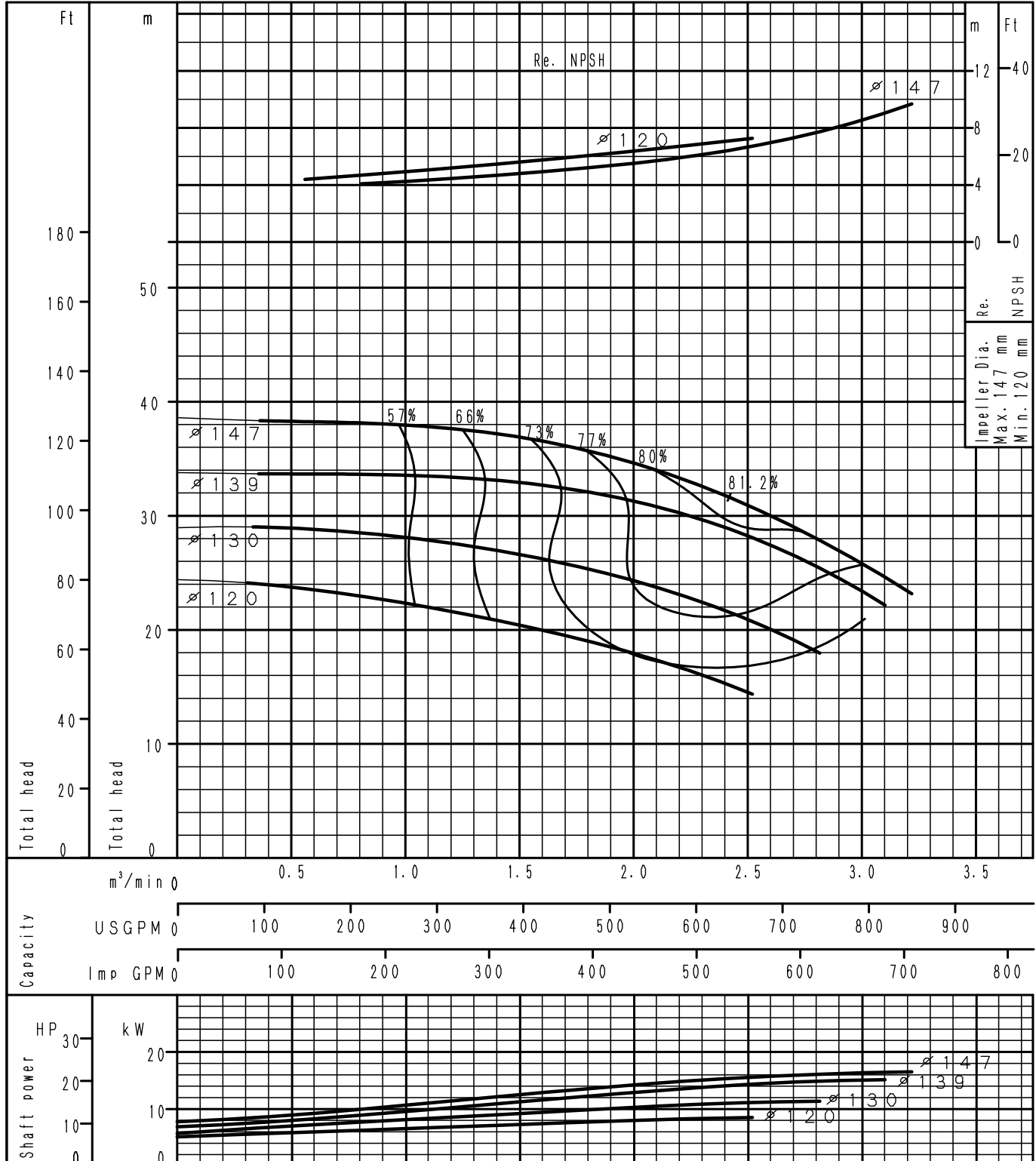

Performance Curve

2 Poles

<h1 style="margin: 0;">GS65-160</h1>	According to ISO testing code 9906 Grade 3B
60Hz ( Speed 3500 min <sup>-1</sup> )	DENSITY= 1.0 kg/l , VISCOSITY= 1.0 mPa·s

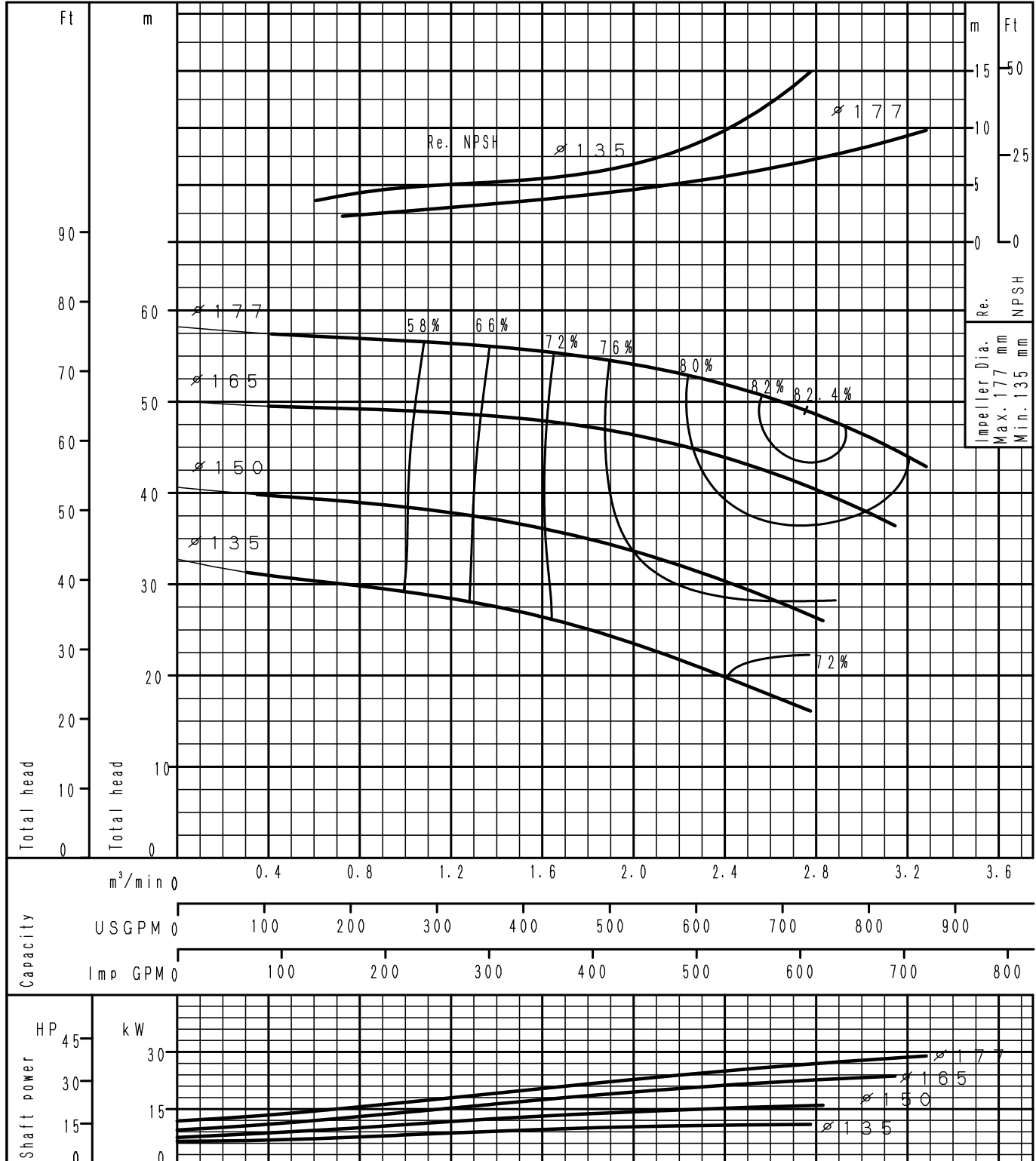

Performance Curve

2 Poles

<h1 style="margin: 0;">GS65-200</h1>	According to ISO testing code 9906 Grade 3B
60Hz ( Speed 3500 min <sup>-1</sup> )	DENSITY= 1.0 kg/l , VISCOSITY= 1.0 mPa·s

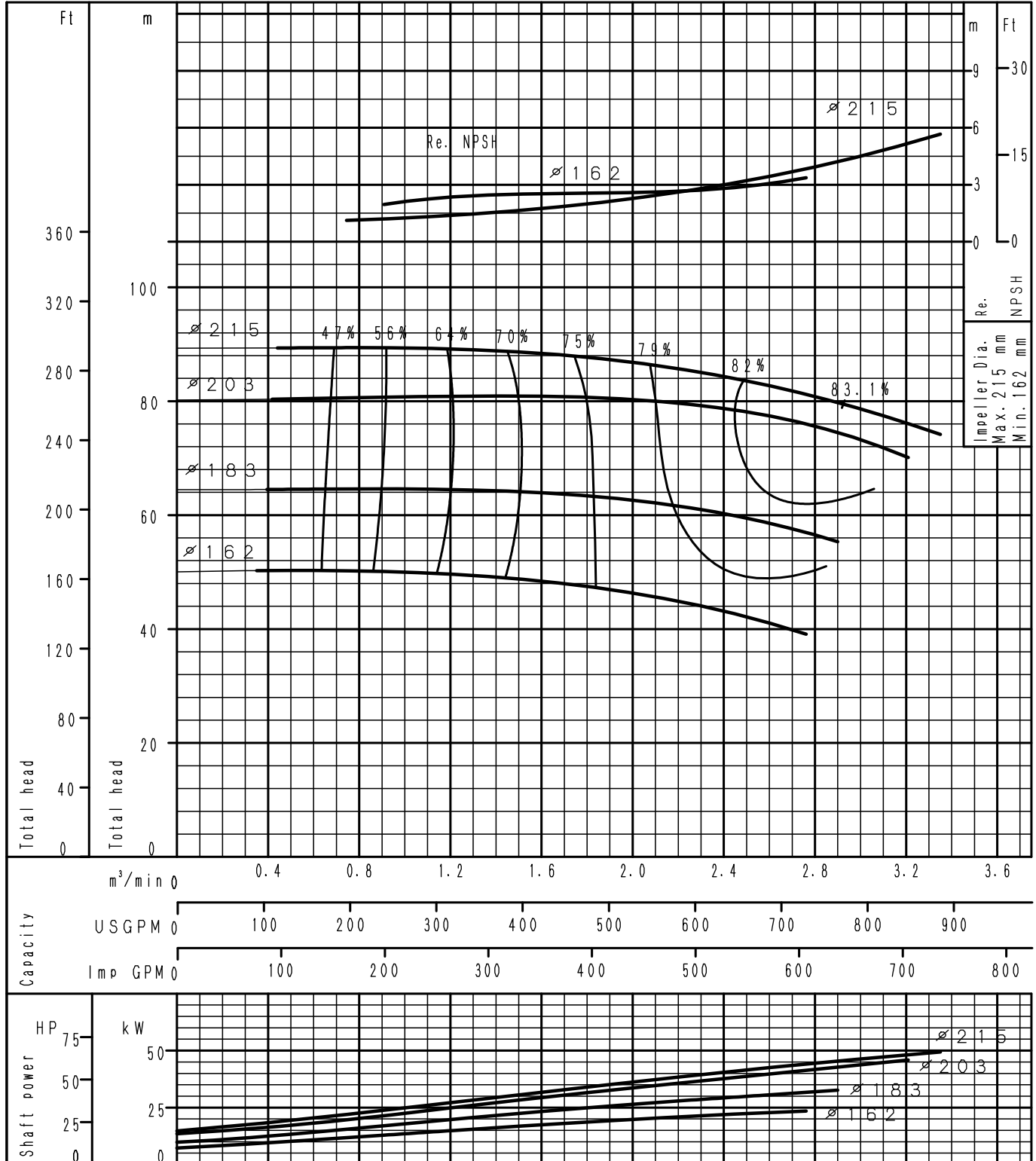

Performance Curve

2 Poles

GS65-250	According to ISO testing code 9906 Grade 3B
60Hz ( Speed 3500 min <sup>-1</sup> )	DENSITY= 1.0 kg/l , VISCOSITY= 1.0 mPa·s

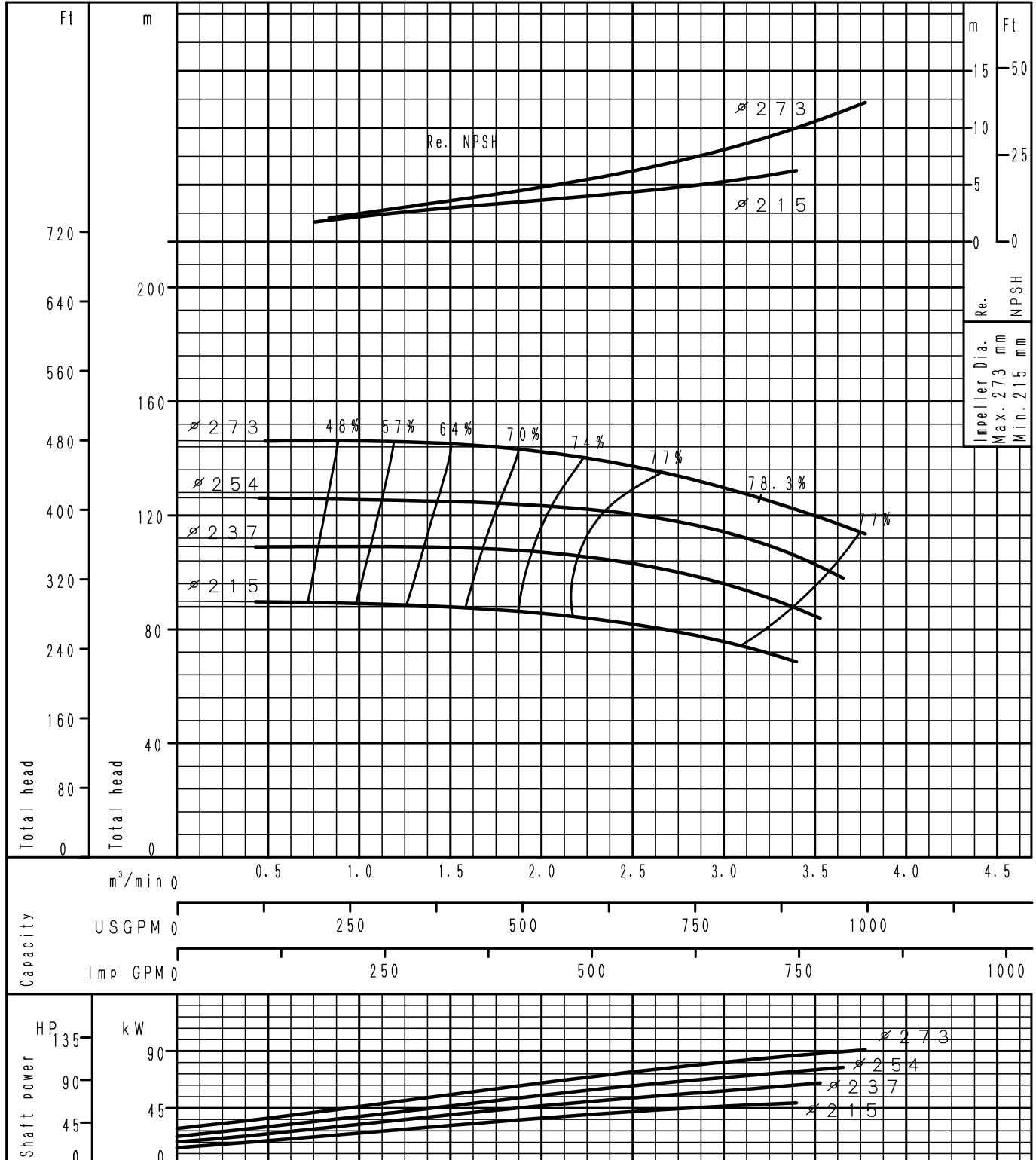

Performance Curve

2 Poles

GS80-160	According to ISO testing code 9906 Grade 3B
60Hz ( Speed 3500 min <sup>-1</sup> )	DENSITY= 1.0 kg/l , VISCOSITY= 1.0 mPa·s

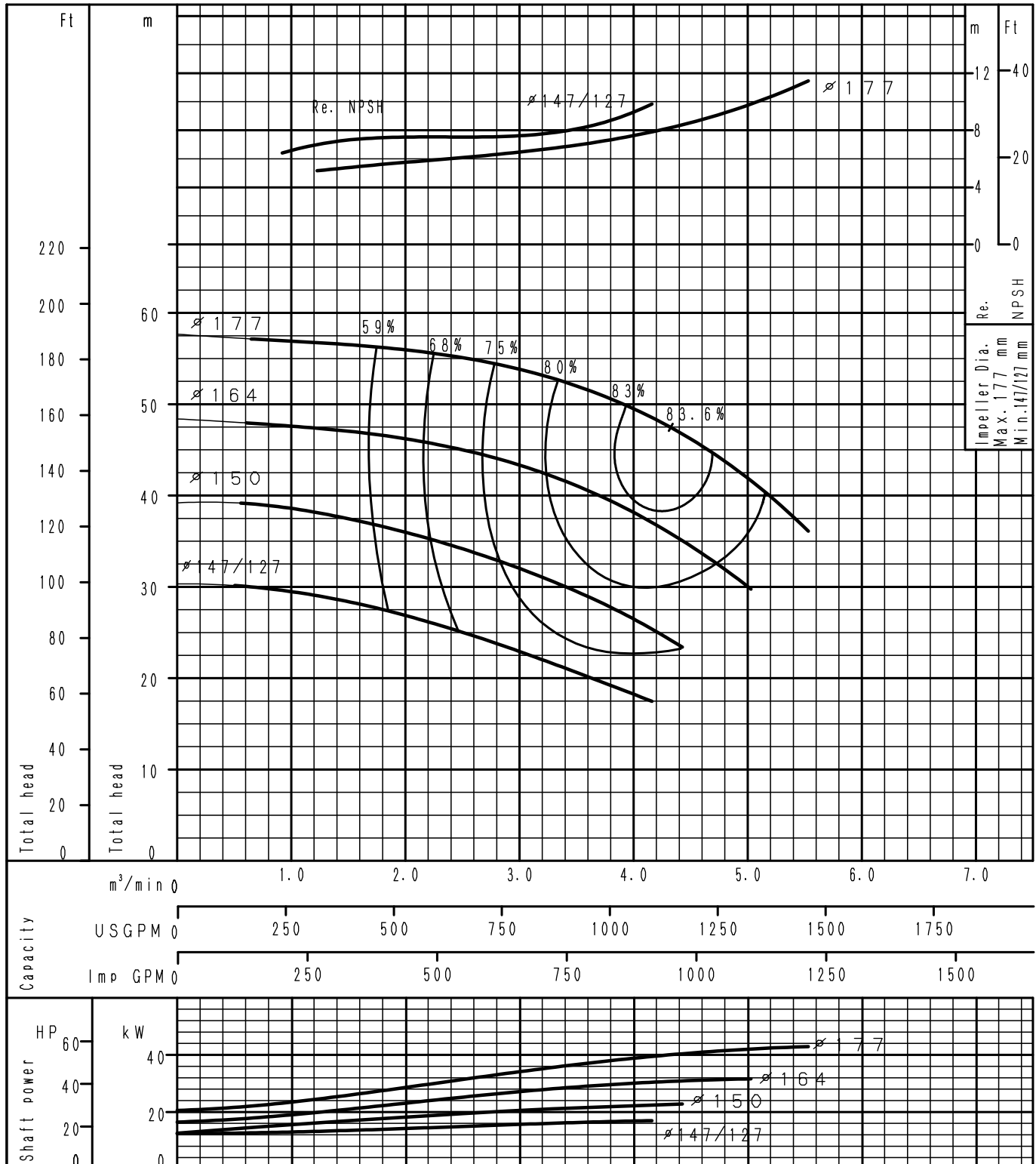



Performance Curve

2 Poles

GS80-200	According to ISO testing code 9906 Grade 3B
60Hz ( Speed 3500 min <sup>-1</sup> )	DENSITY= 1.0 kg/l , VISCOSITY= 1.0 mPa·s

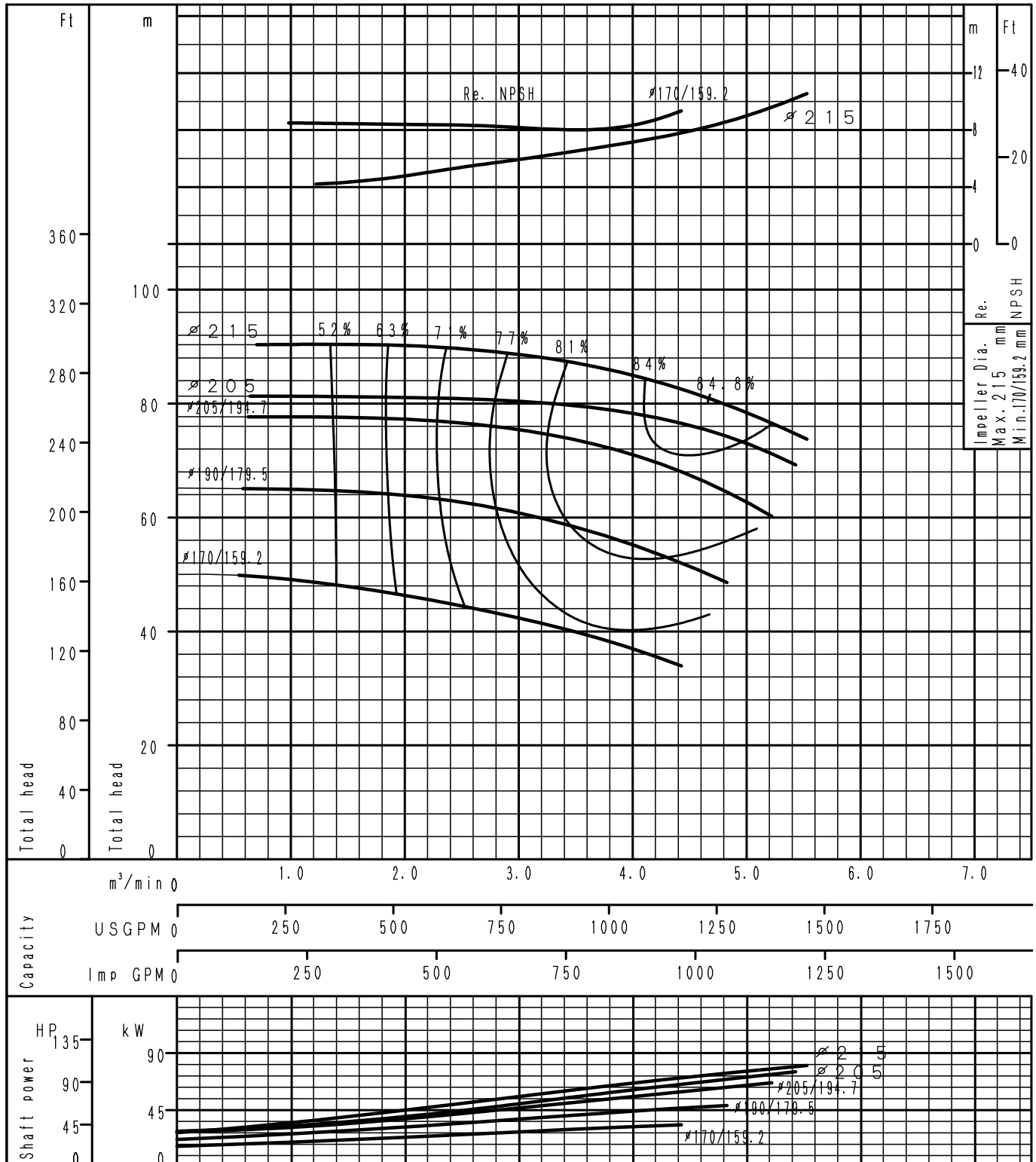

Performance Curve

2 Poles

GS80-250	According to ISO testing code 9906 Grade 3B
60Hz ( Speed 3500 min <sup>-1</sup> )	DENSITY= 1.0 kg/l , VISCOSITY= 1.0 mPa·s

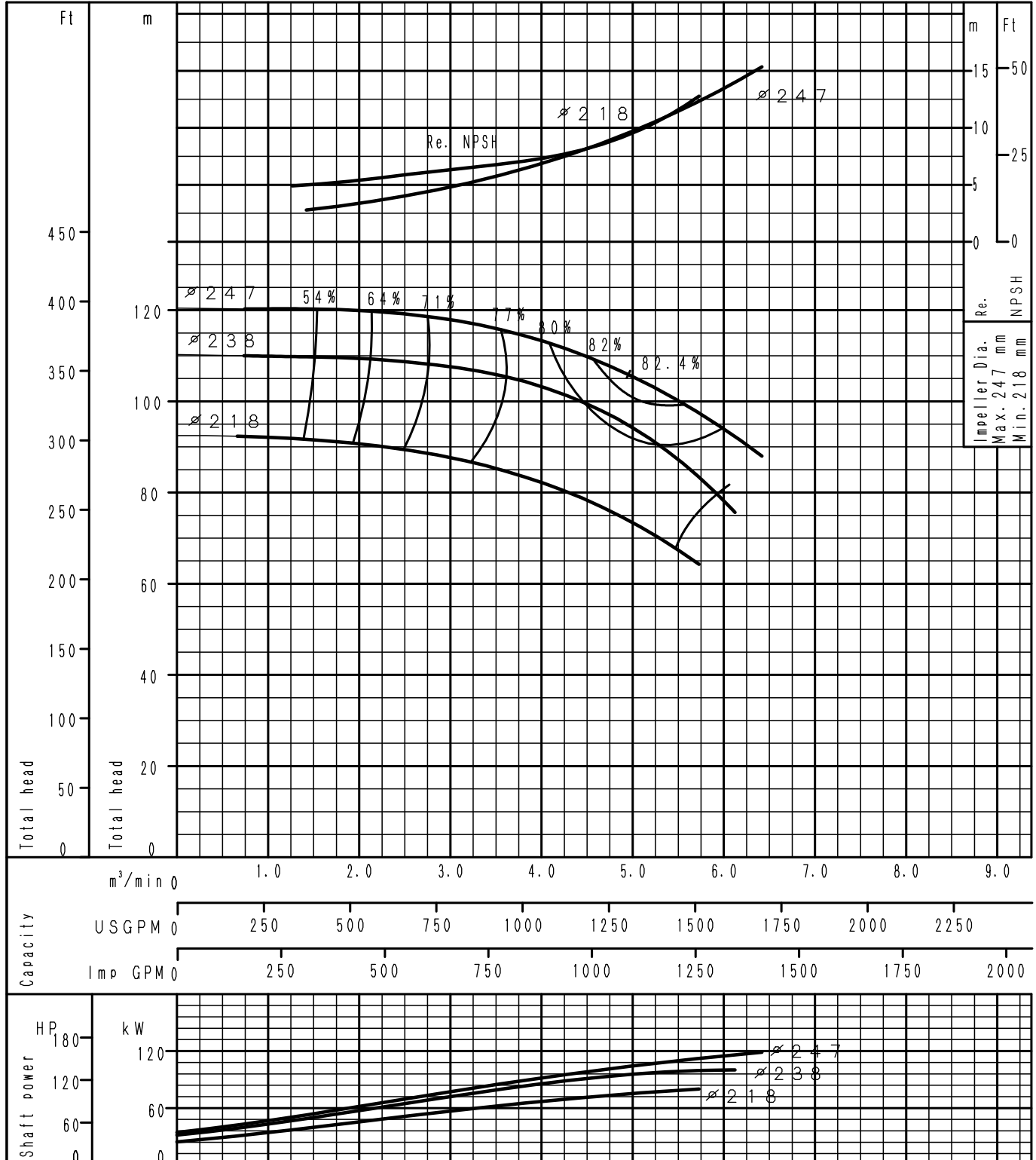

Performance Curve

2 Poles

GS100-160	According to ISO testing code 9906 Grade 3B
60Hz ( Speed 3500 min <sup>-1</sup> )	DENSITY= 1.0 kg/l , VISCOSITY= 1.0 mPa·s

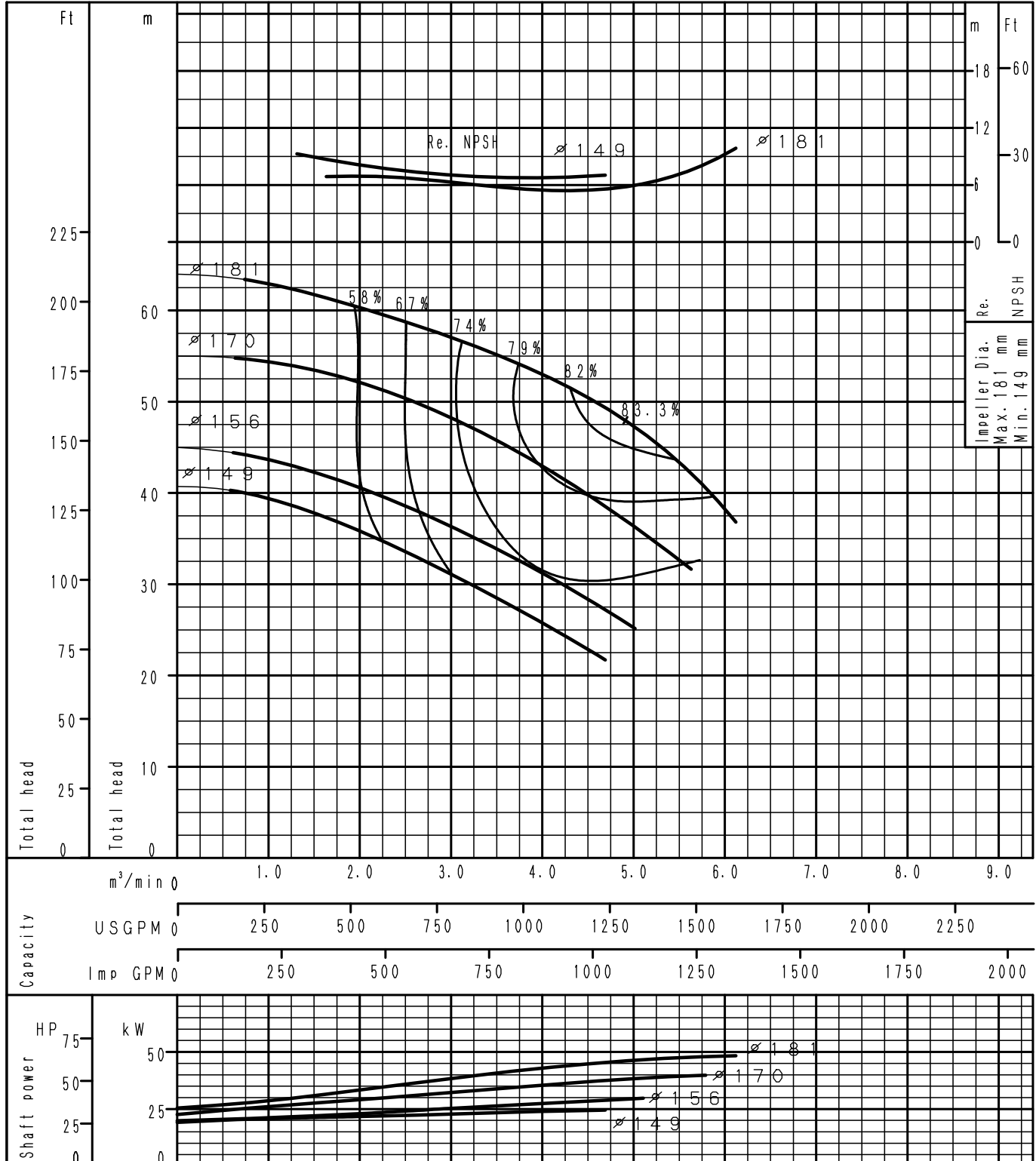

Performance Curve

2 Poles

GS100-200	According to ISO testing code 9906 Grade 3B
60Hz ( Speed 3500 min <sup>-1</sup> )	DENSITY= 1.0 kg/l , VISCOSITY= 1.0 mPa·s

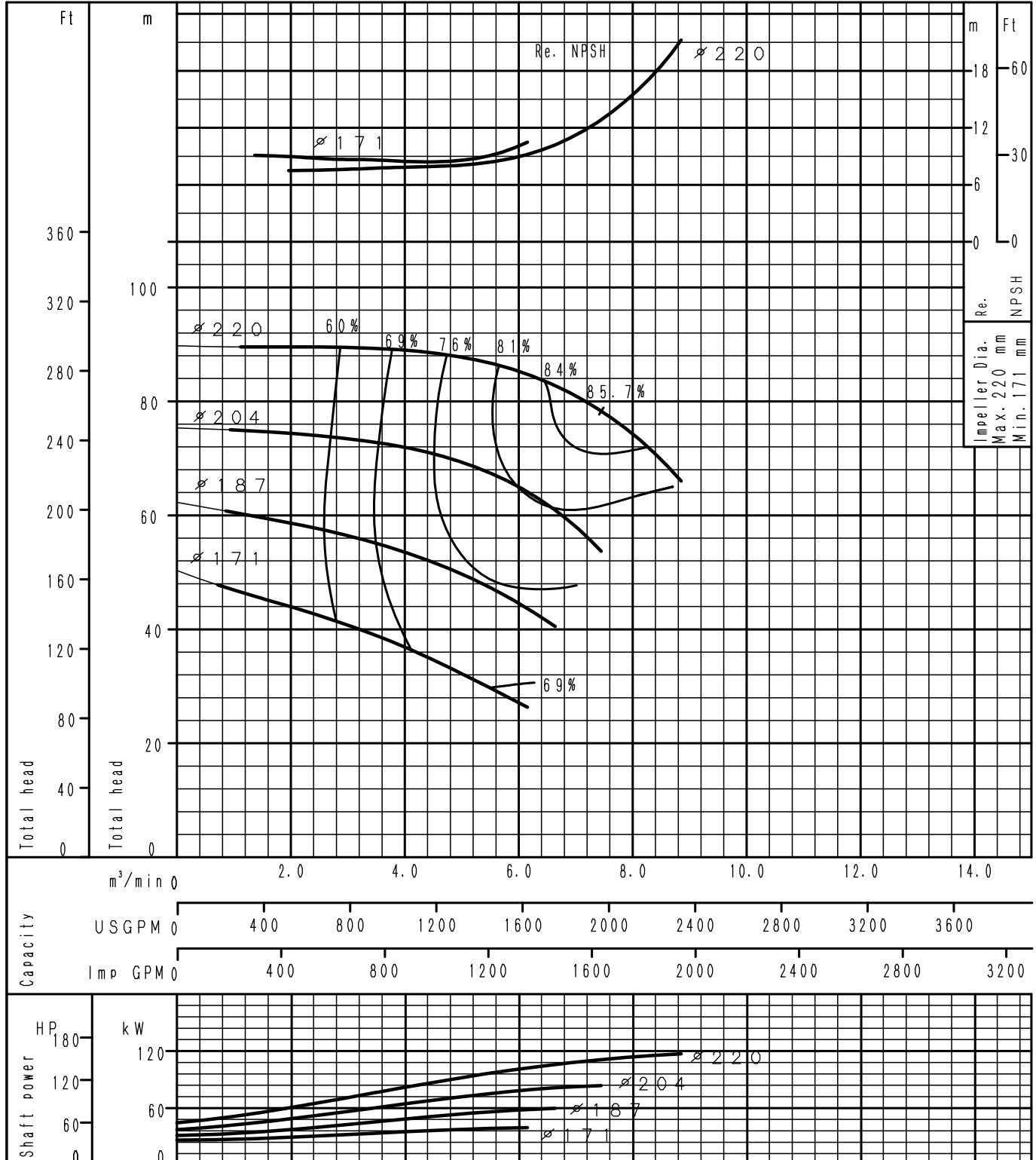

Performance Curve

2 Poles

GS100-250L	According to ISO testing code 9906 Grade 3B
60Hz ( Speed 3500 min <sup>-1</sup> )	DENSITY= 1.0 kg/l , VISCOSITY= 1.0 mPa·s

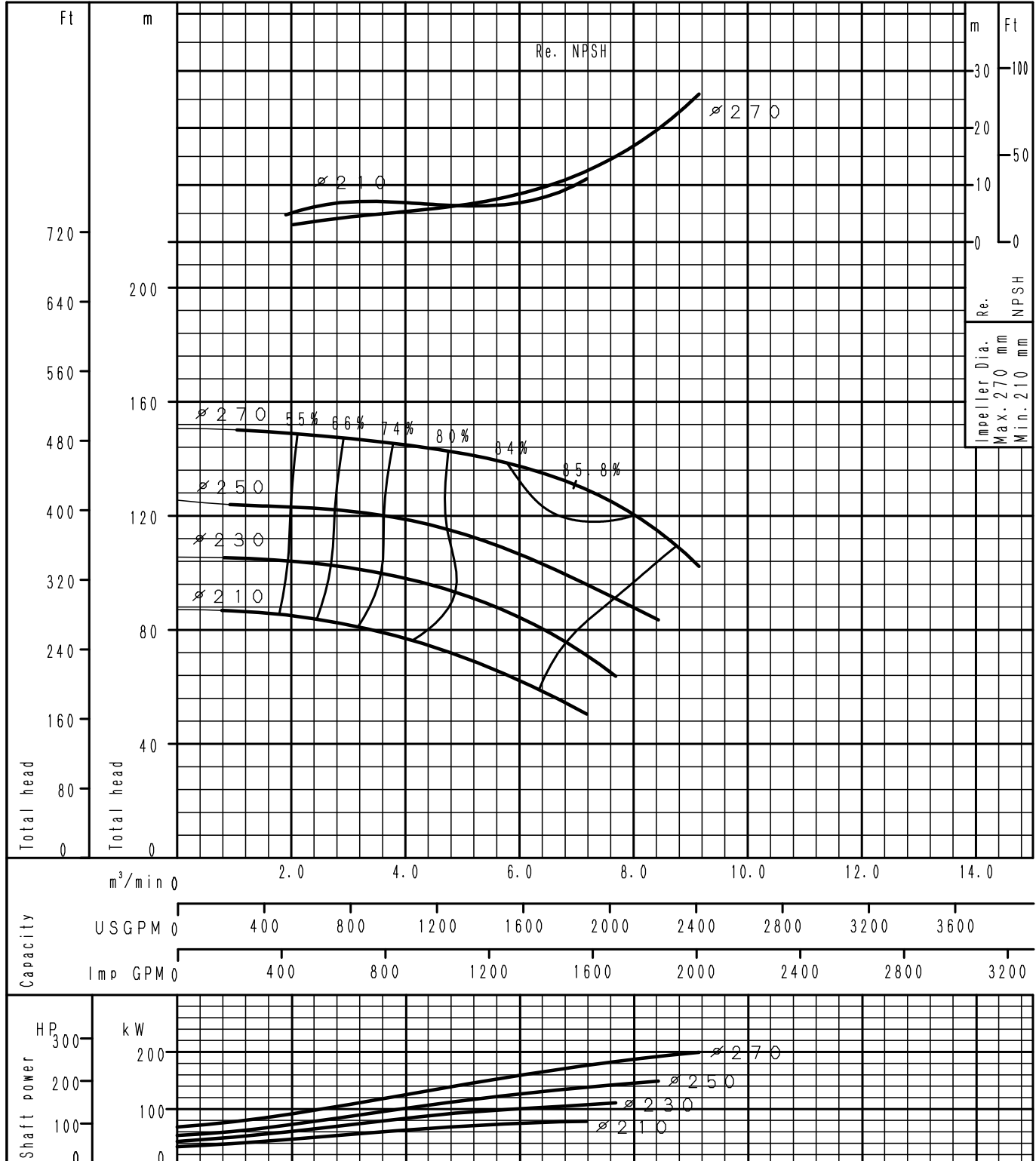

Performance Curve

2 Poles

GS125-200	According to ISO testing code 9906 Grade 3B
60Hz ( Speed 3500 min <sup>-1</sup> )	DENSITY= 1.0 kg/l , VISCOSITY= 1.0 mPa·s

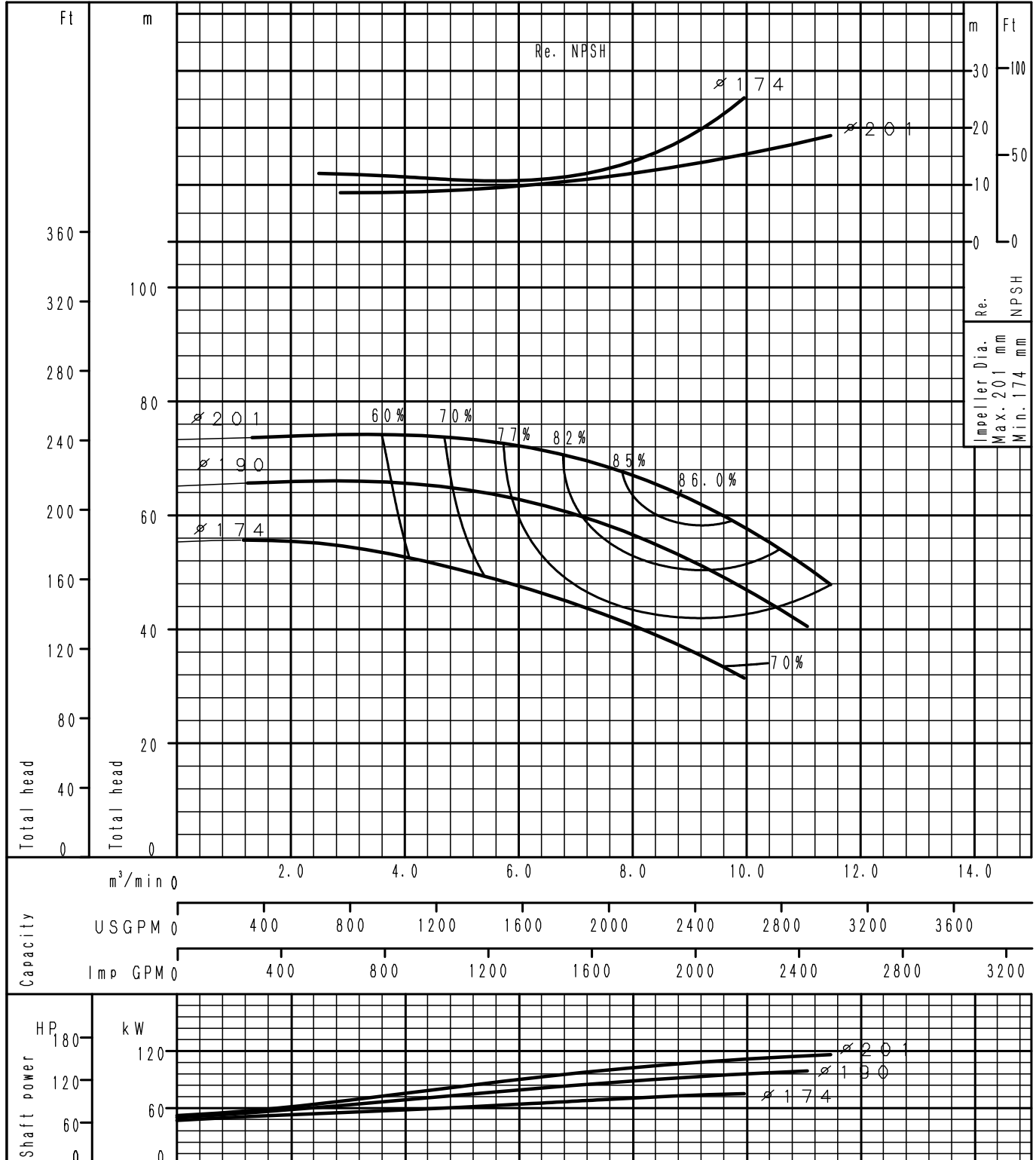

Performance Curve

2 Poles

GS125-250L	According to ISO testing code 9906 Grade 3B
60Hz ( Speed 3500 min <sup>-1</sup> )	DENSITY= 1.0 kg/l , VISCOSITY= 1.0 mPa·s

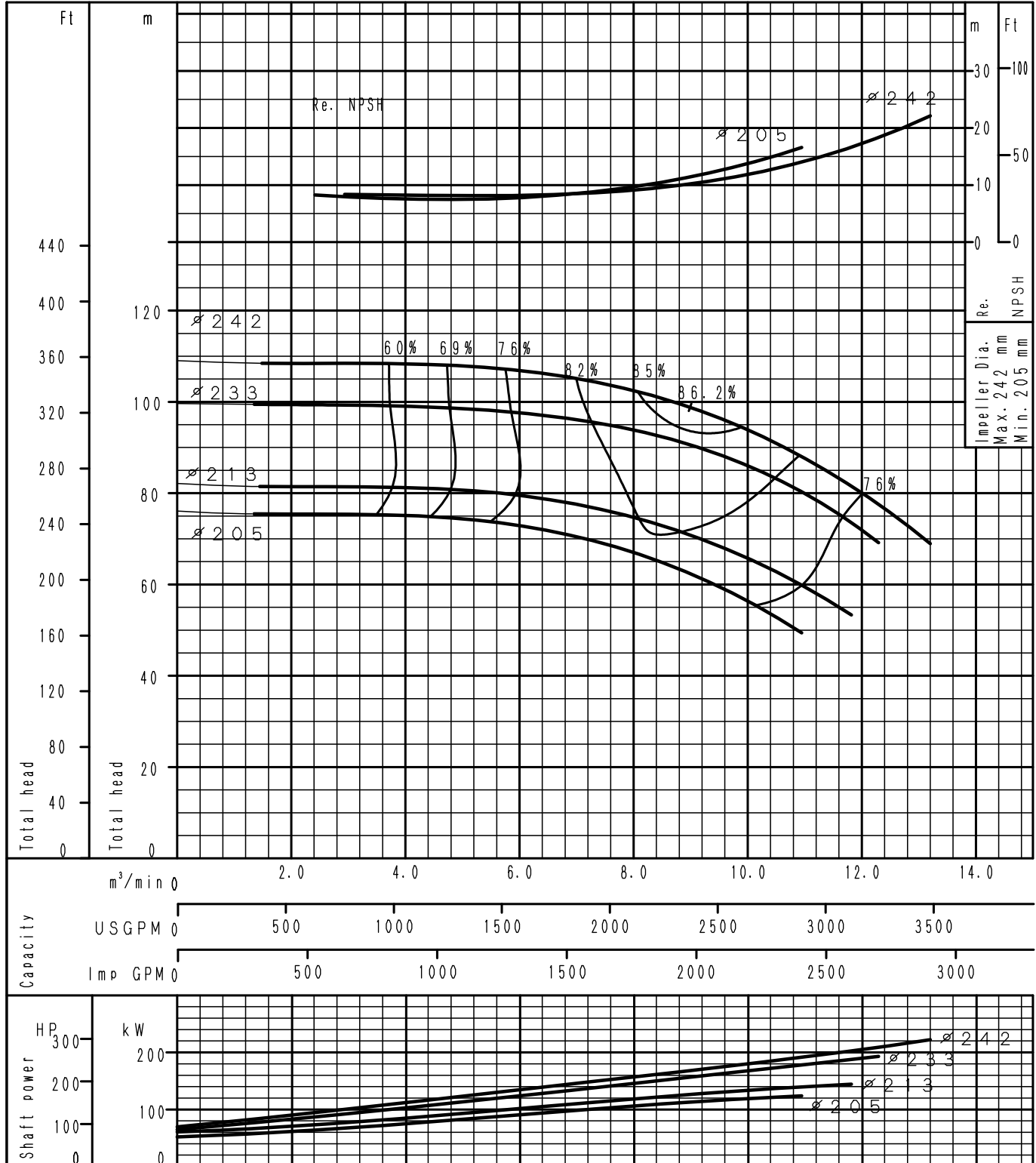

Performance Curve

2 Poles

GS150-200	According to ISO testing code 9906 Grade 3B
60Hz ( Speed 3500 min <sup>-1</sup> )	DENSITY= 1.0 kg/l , VISCOSITY= 1.0 mPa·s

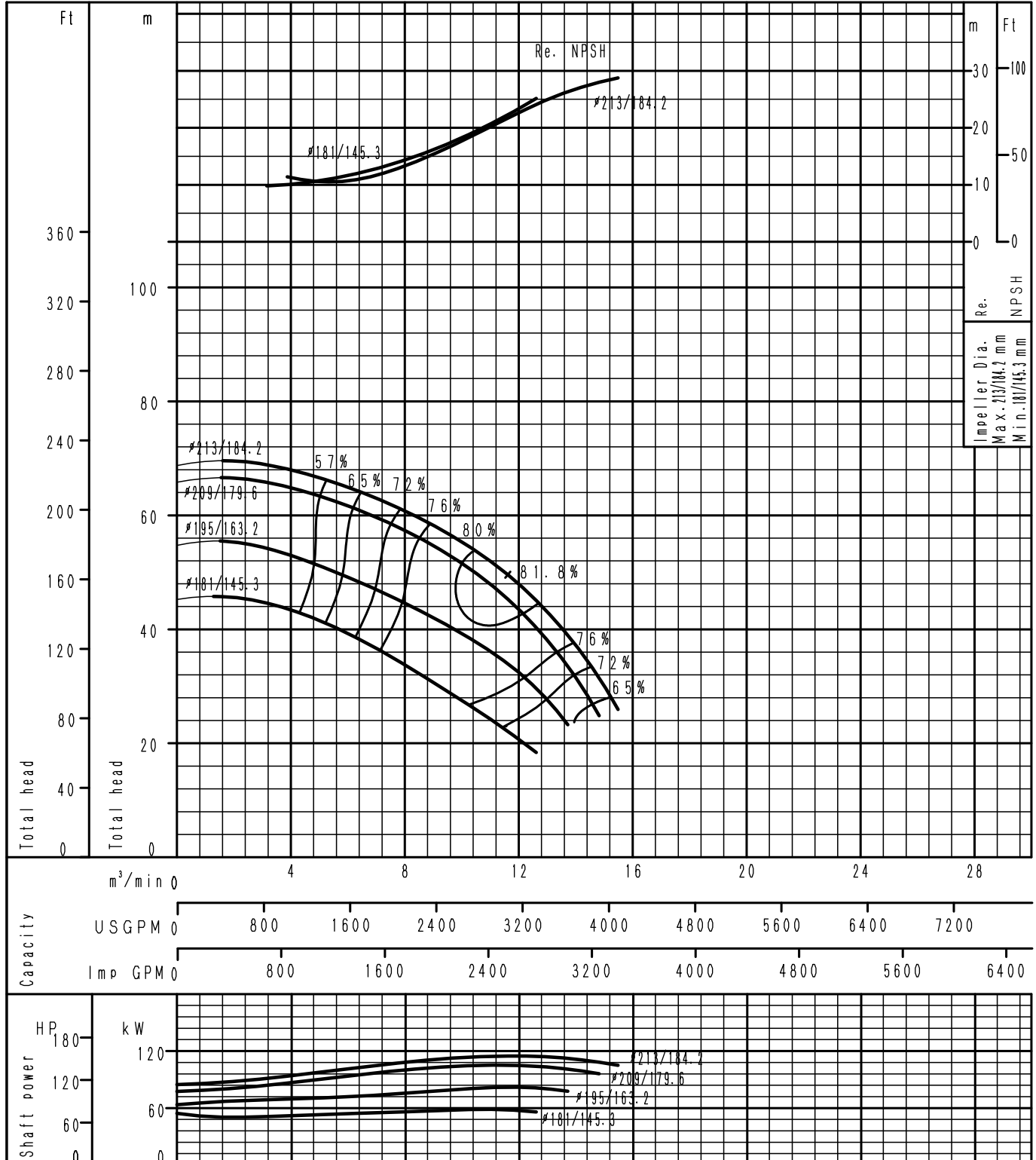



Performance Curve

4 Poles

GS32-125.1	According to ISO testing code 9906 Grade 3B
60Hz ( Speed 1750 min <sup>-1</sup> )	DENSITY= 1.0 kg/l , VISCOSITY= 1.0 mPa·s

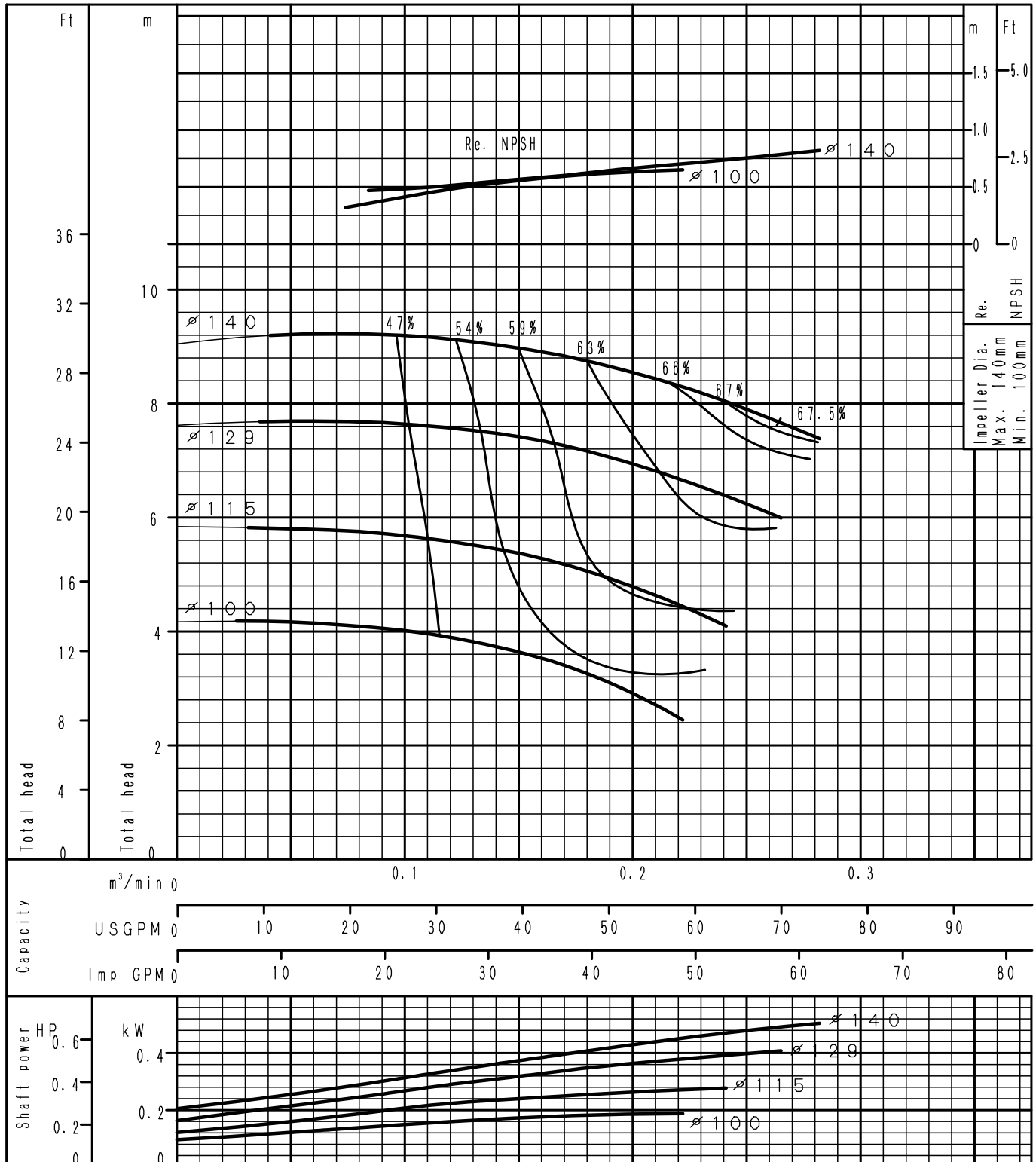

Performance Curve

4 Poles

GS32-160.1	According to ISO testing code 9906 Grade 3B
60Hz ( Speed 1750 min <sup>-1</sup> )	DENSITY= 1.0 kg/l , VISCOSITY= 1.0 mPa·s

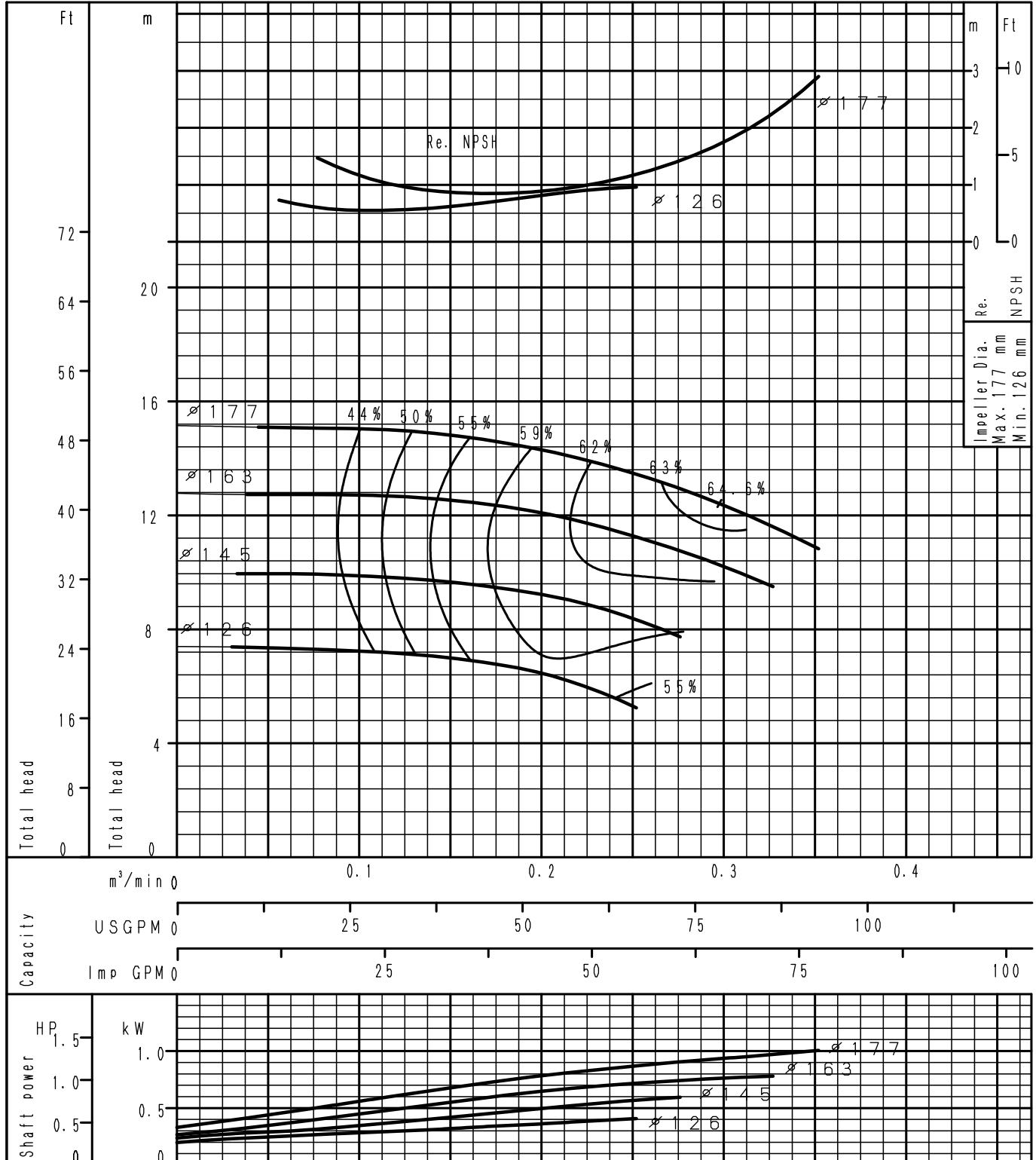

Performance Curve

4 Poles

GS32-200.1	According to ISO testing code 9906 Grade 3B
60Hz ( Speed 1750 min <sup>-1</sup> )	DENSITY= 1.0 kg/l , VISCOSITY= 1.0 mPa·s

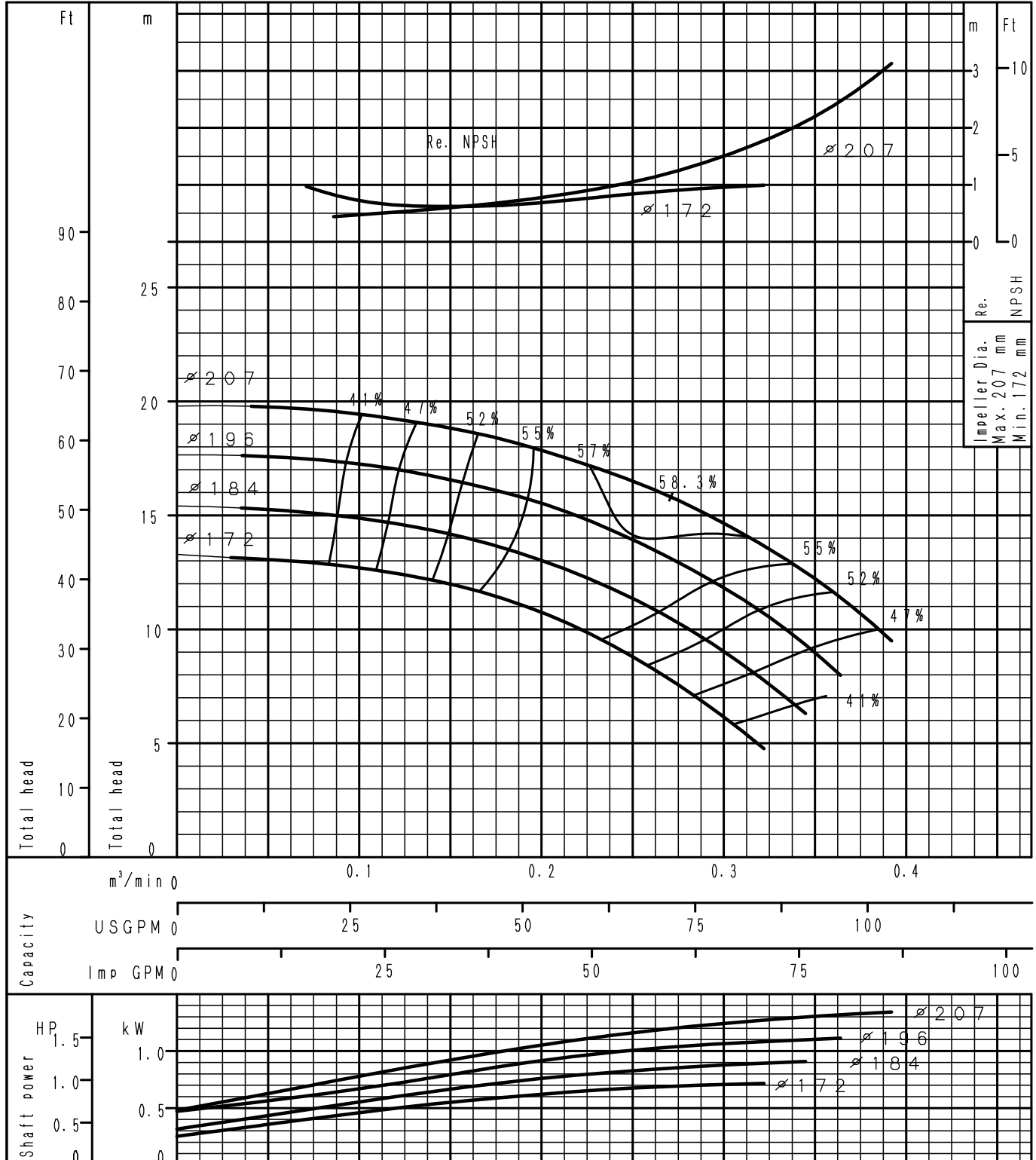

Performance Curve

4 Poles

GS32-125	According to ISO testing code 9906 Grade 3B
60Hz ( Speed 1750 min <sup>-1</sup> )	DENSITY= 1.0 kg/l , VISCOSITY= 1.0 mPa·s

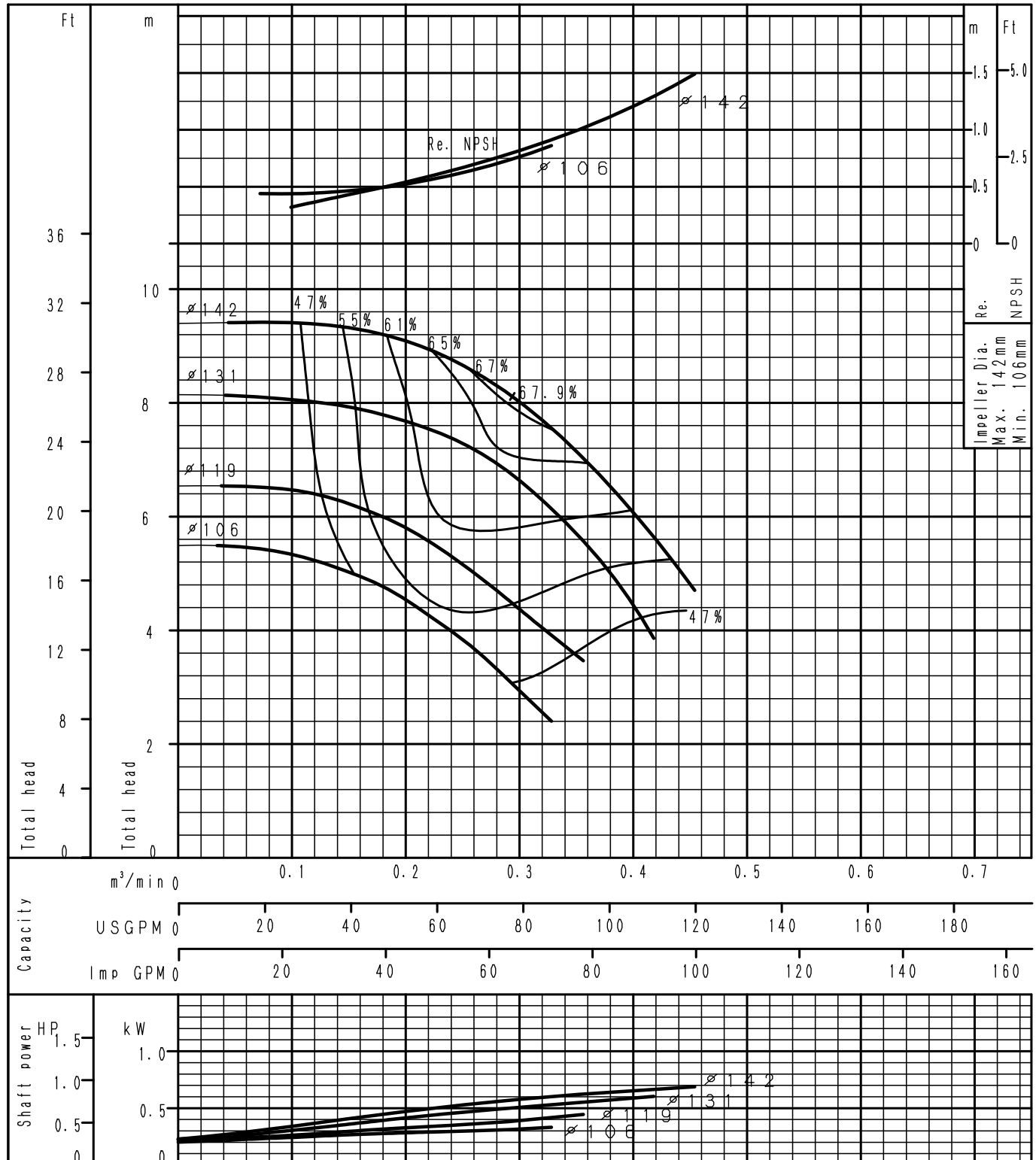

Performance Curve

4 Poles

GS32-160	According to ISO testing code 9906 Grade 3B
60Hz ( Speed 1750 min <sup>-1</sup> )	DENSITY= 1.0 kg/l , VISCOSITY= 1.0 mPa·s

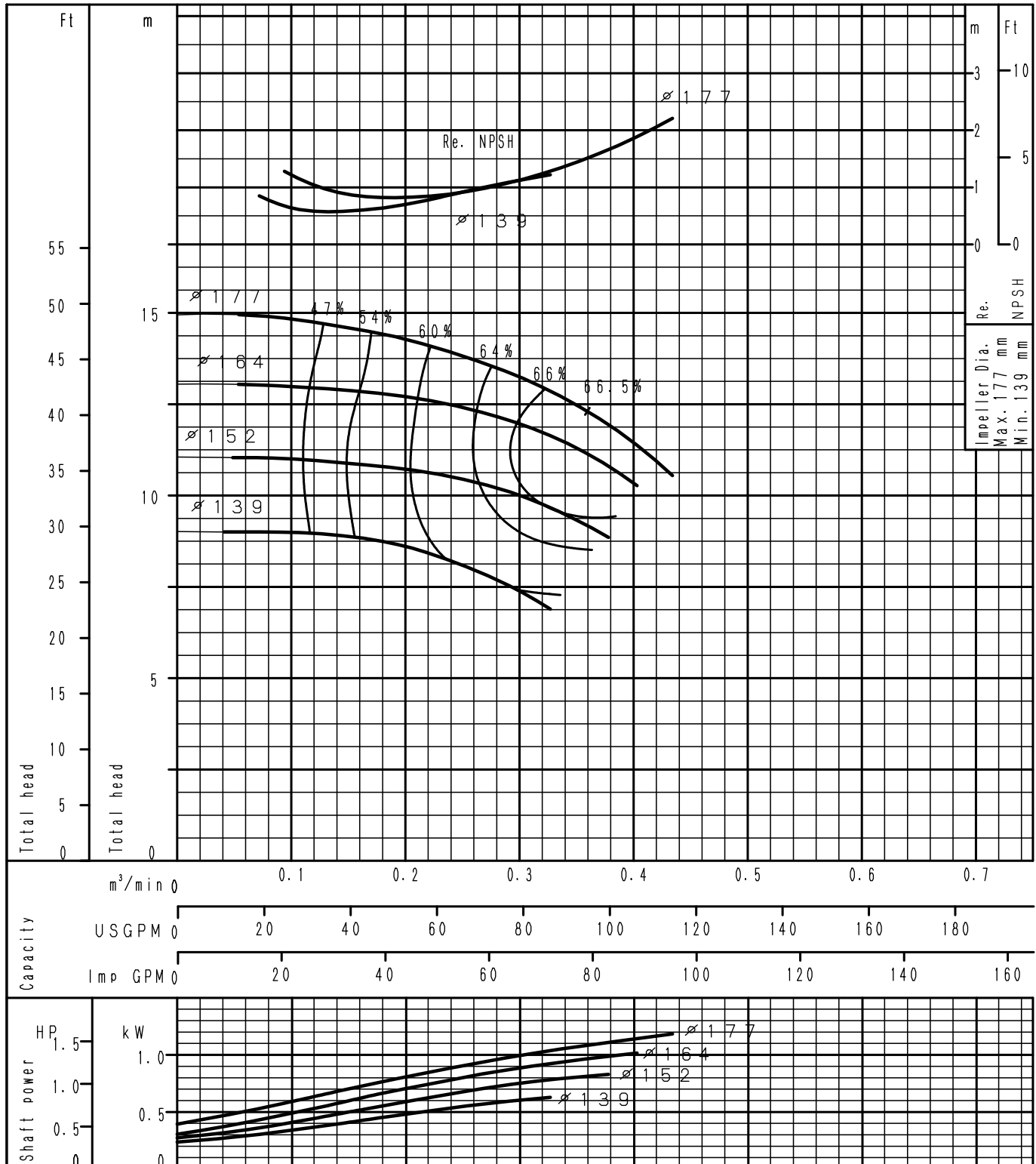

Performance Curve

4 Poles

GS32-200	According to ISO testing code 9906 Grade 3B
60Hz ( Speed 1750 min <sup>-1</sup> )	DENSITY= 1.0 kg/l , VISCOSITY= 1.0 mPa·s

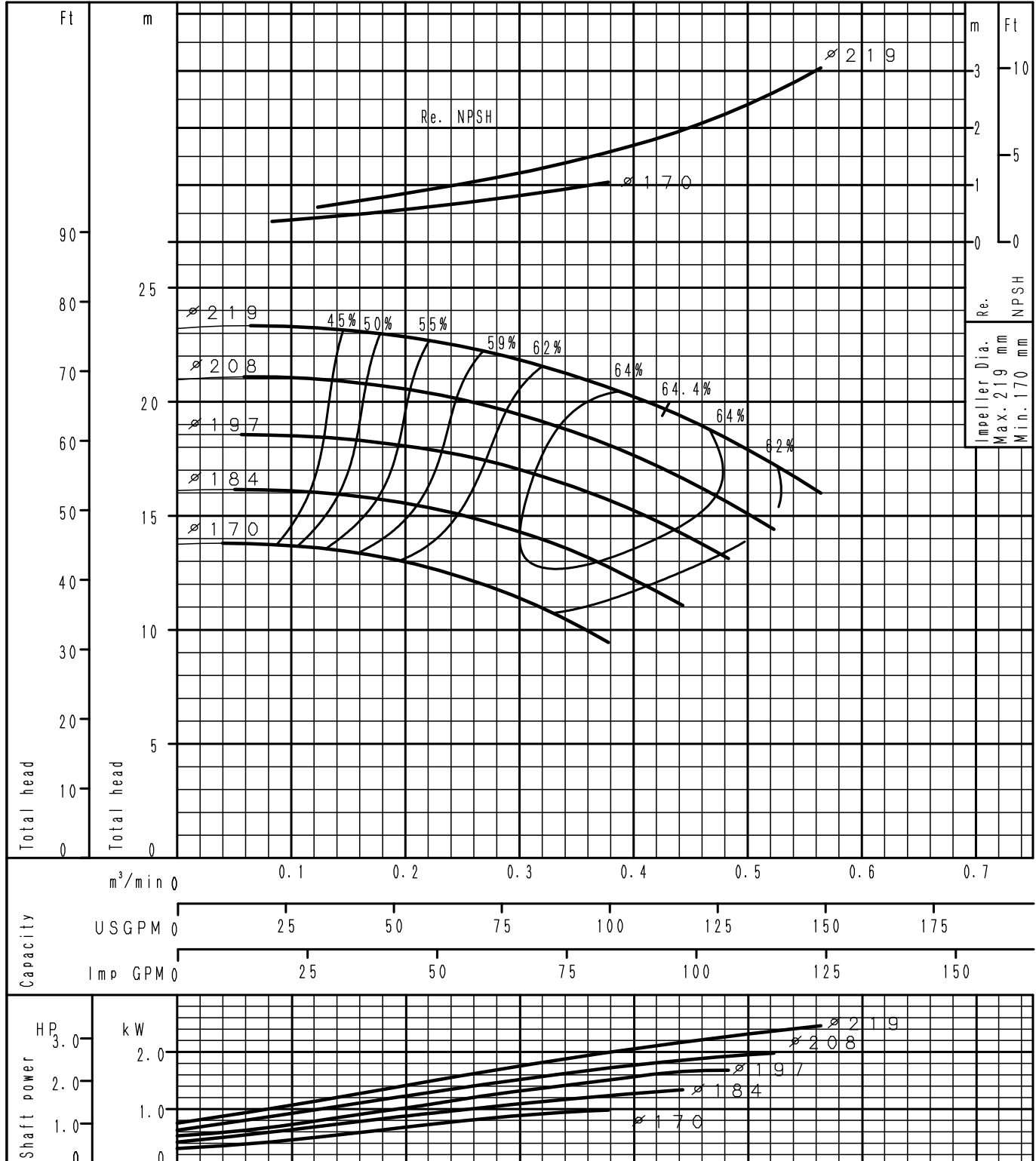

Performance Curve

4 Poles

GS32-250	According to ISO testing code 9906 Grade 3B
60Hz ( Speed 1750 min <sup>-1</sup> )	DENSITY= 1.0 kg/l , VISCOSITY= 1.0 mPa·s

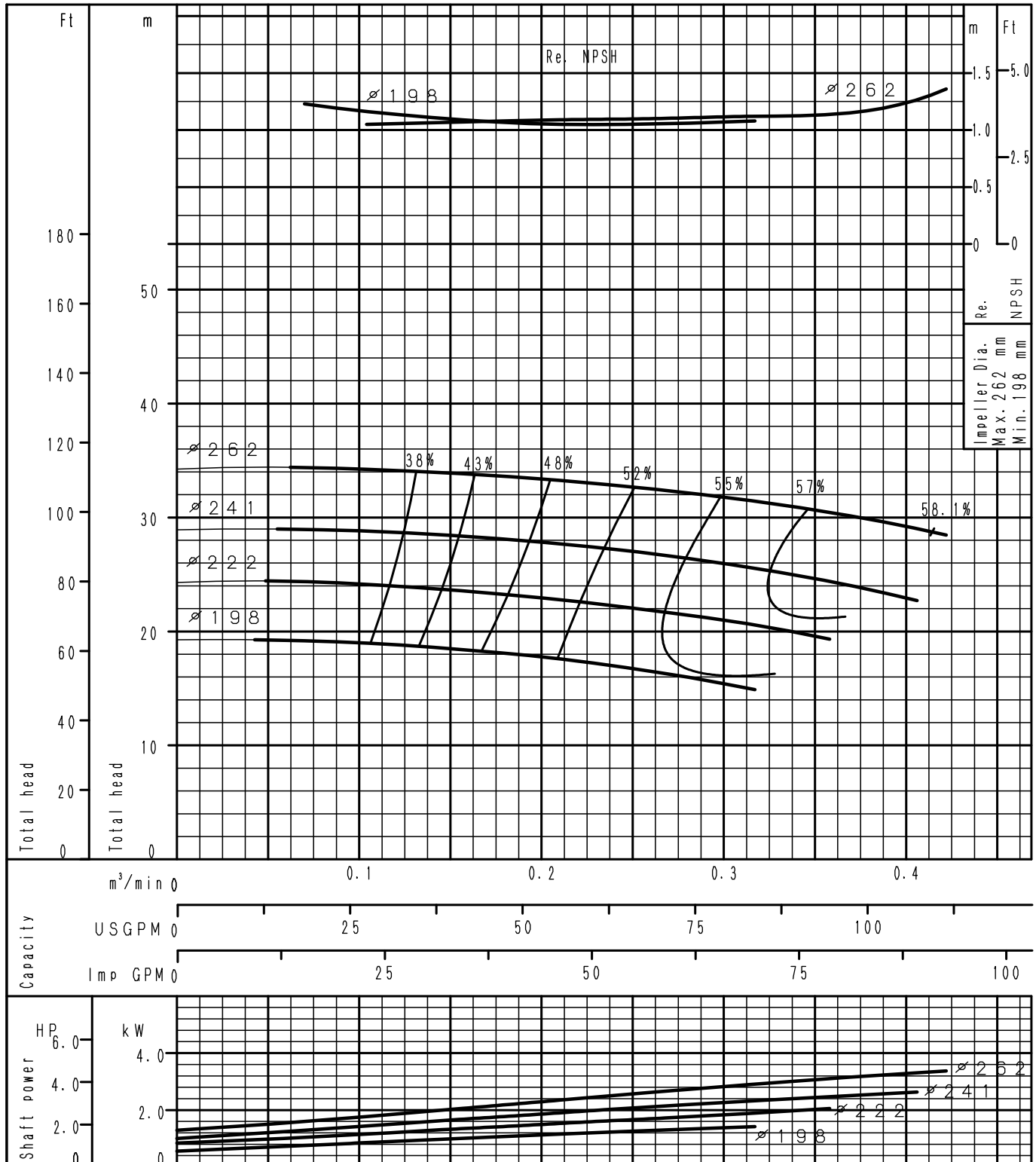

Performance Curve

4 Poles

GS40-125	According to ISO testing code 9906 Grade 3B
60Hz ( Speed 1750 min <sup>-1</sup> )	DENSITY= 1.0 kg/l , VISCOSITY= 1.0 mPa·s

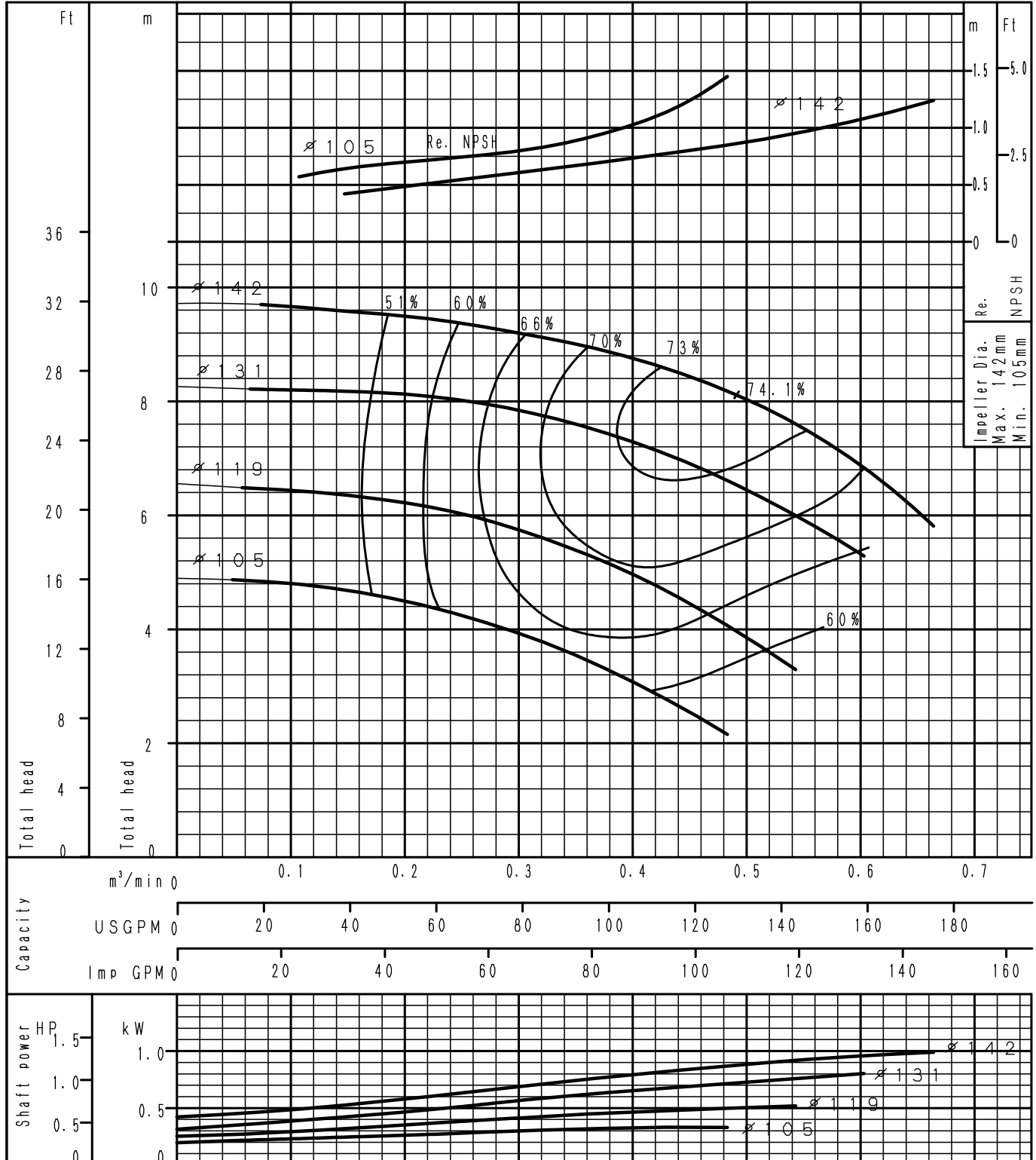



Performance Curve

4 Poles

GS40-160	According to ISO testing code 9906 Grade 3B
60Hz ( Speed 1750 min <sup>-1</sup> )	DENSITY= 1.0 kg/l , VISCOSITY= 1.0 mPa·s

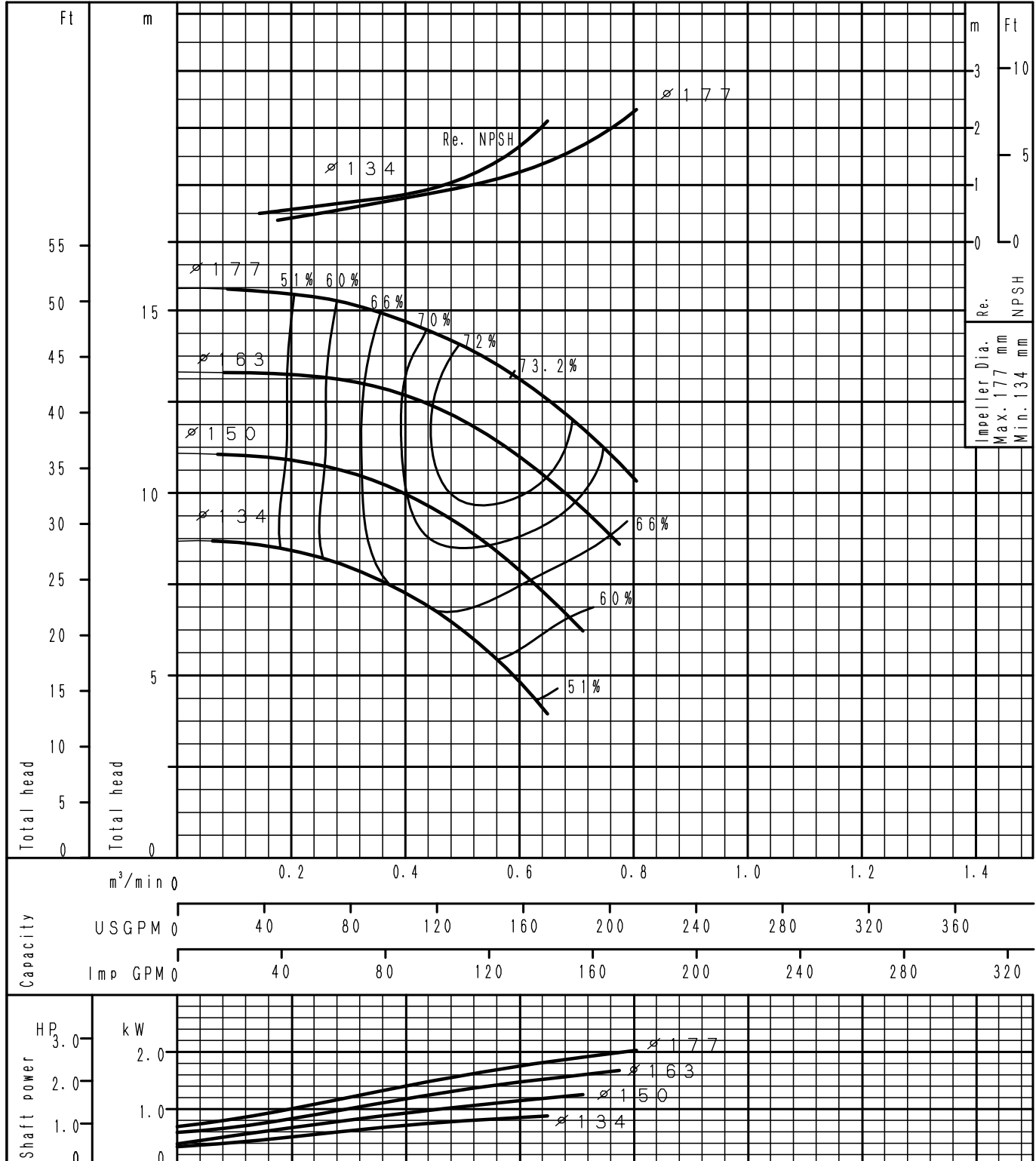

Performance Curve

4 Poles

<h1 style="margin: 0;">GS40-200</h1>	According to ISO testing code 9906 Grade 3B
60Hz ( Speed 1750 min <sup>-1</sup> )	DENSITY= 1.0 kg/l , VISCOSITY= 1.0 mPa·s

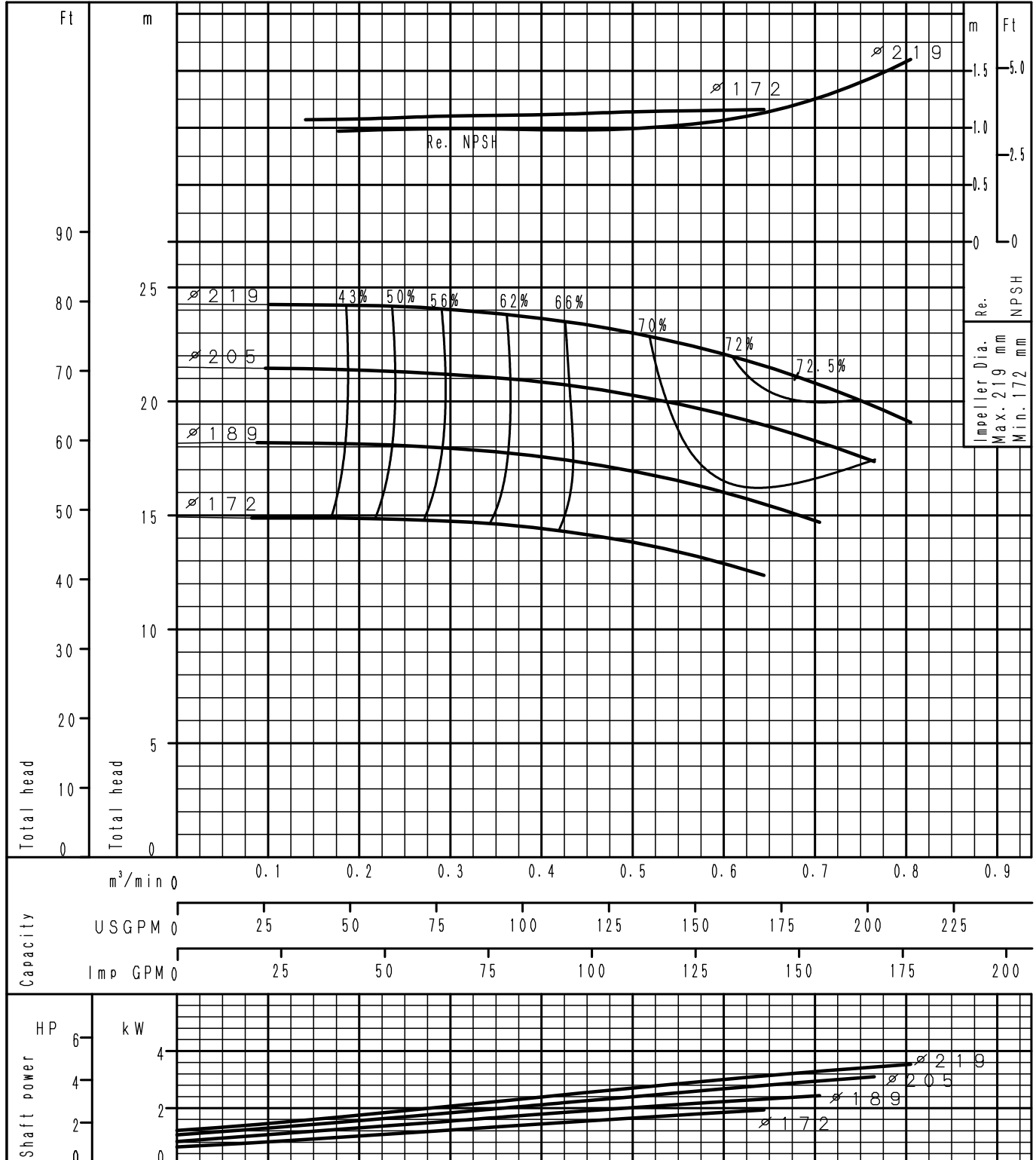

Performance Curve

4 Poles

<h1 style="margin: 0;">GS40-250</h1>	According to ISO testing code 9906 Grade 3B
60Hz ( Speed 1750 min <sup>-1</sup> )	DENSITY= 1.0 kg/l , VISCOSITY= 1.0 mPa·s

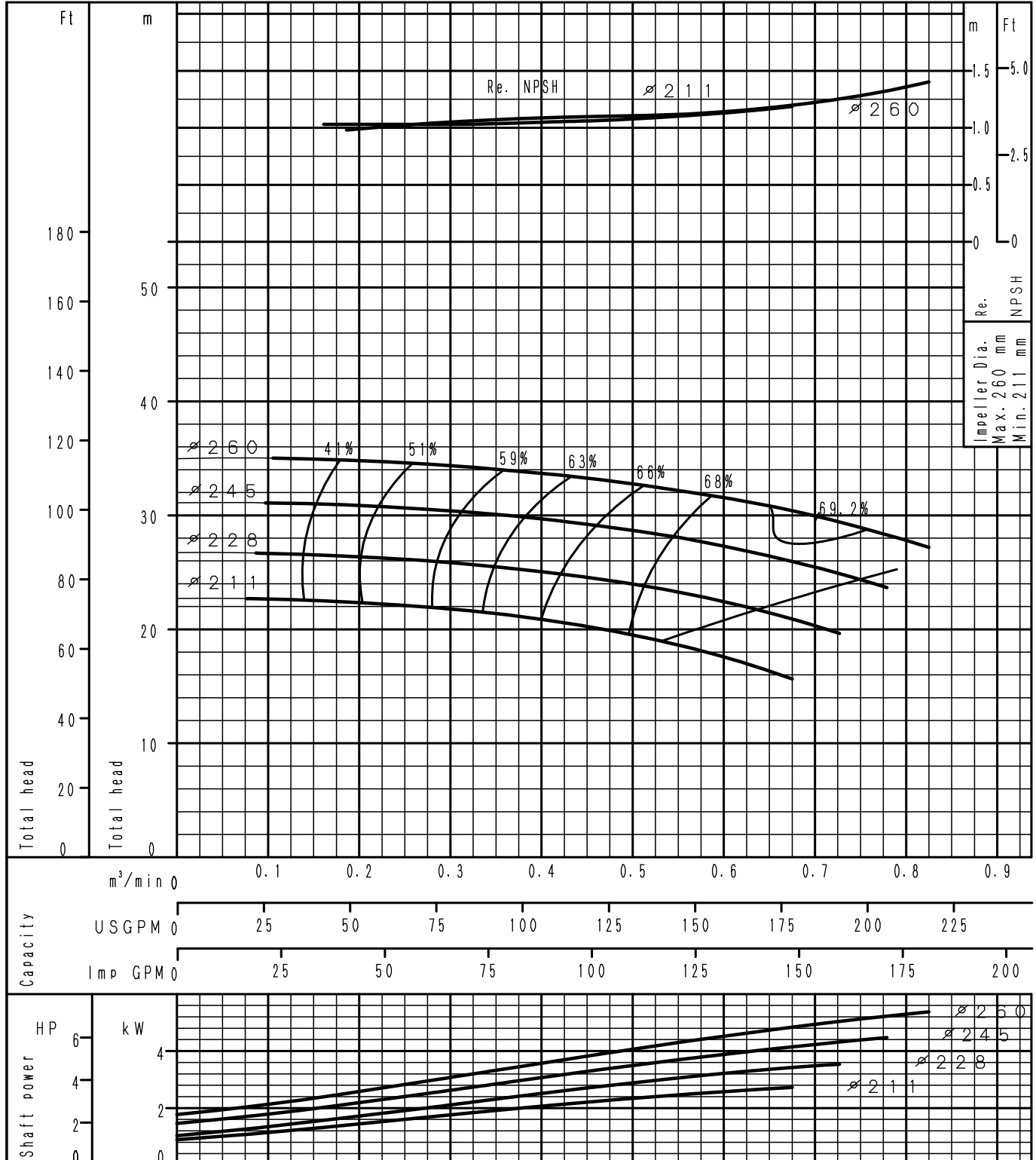

Performance Curve

4 Poles

GS40-315	According to ISO testing code 9906 Grade 3B
60Hz ( Speed 1750 min <sup>-1</sup> )	DENSITY= 1.0 kg/l , VISCOSITY= 1.0 mPa·s

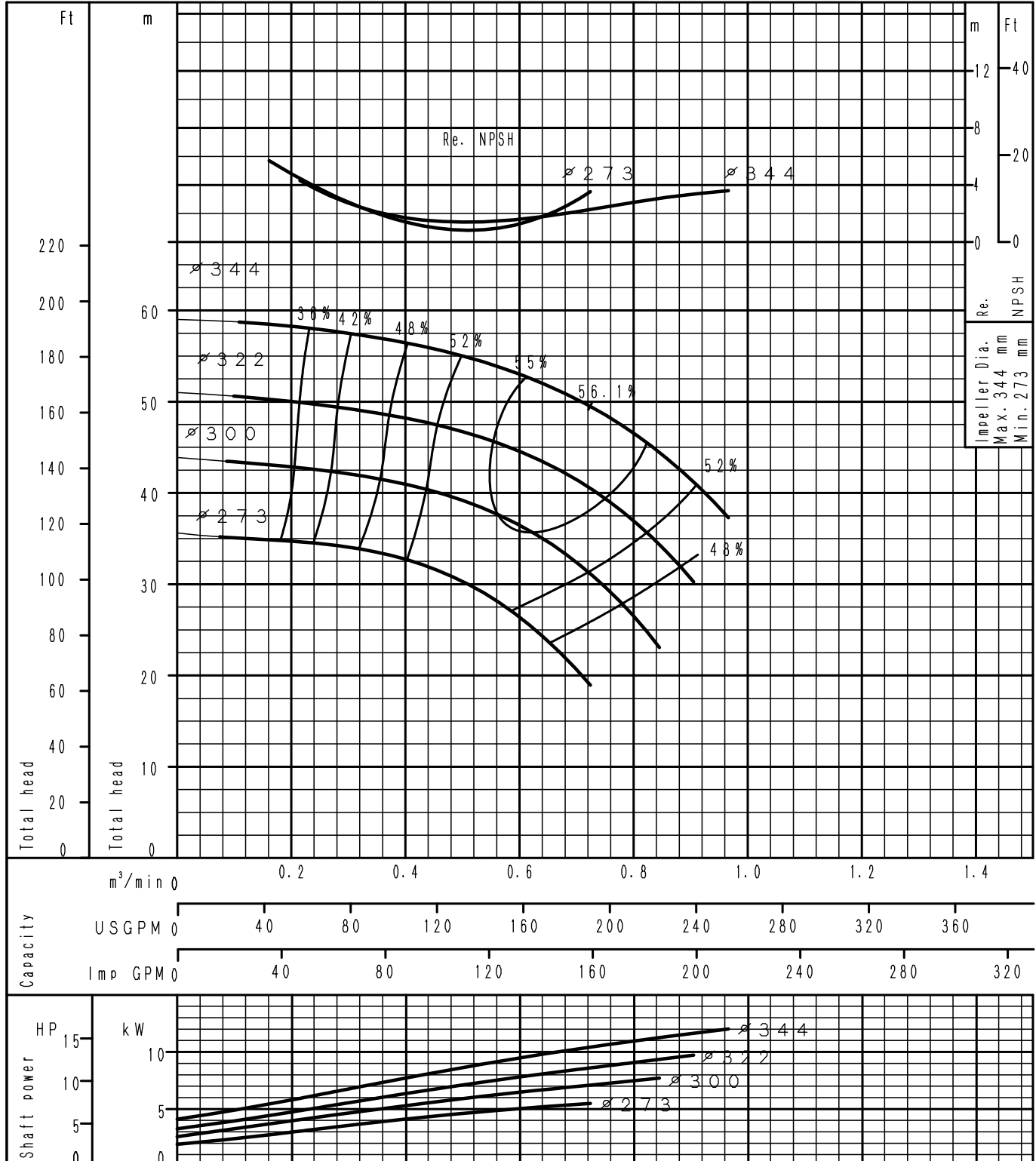

Performance Curve

4 Poles

GS50-125	According to ISO testing code 9906 Grade 3B
60Hz ( Speed 1750 min <sup>-1</sup> )	DENSITY= 1.0 kg/l , VISCOSITY= 1.0 mPa·s

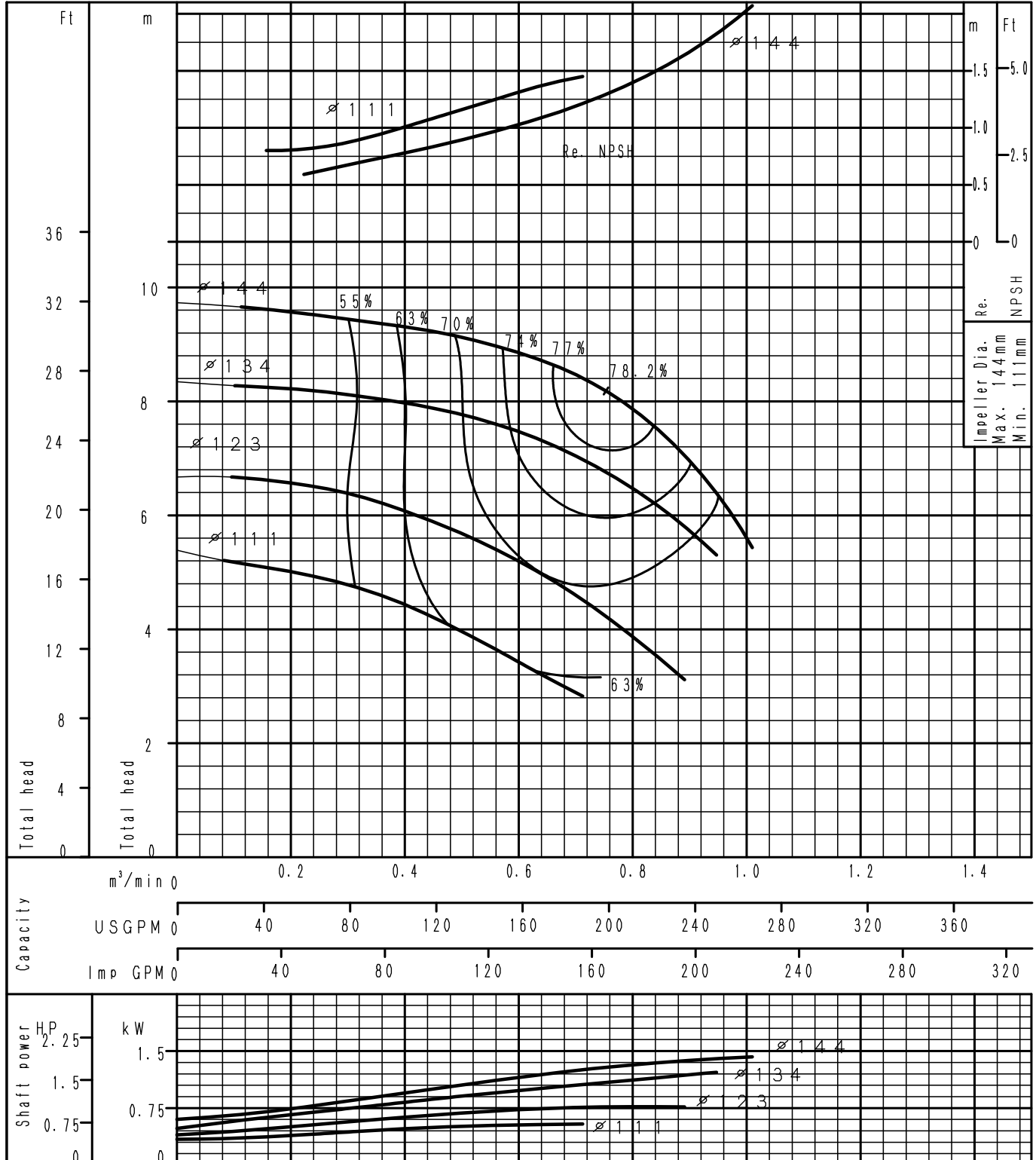

Performance Curve

4 Poles

GS50-160	According to ISO testing code 9906 Grade 3B
60Hz ( Speed 1750 min <sup>-1</sup> )	DENSITY= 1.0 kg/l , VISCOSITY= 1.0 mPa·s

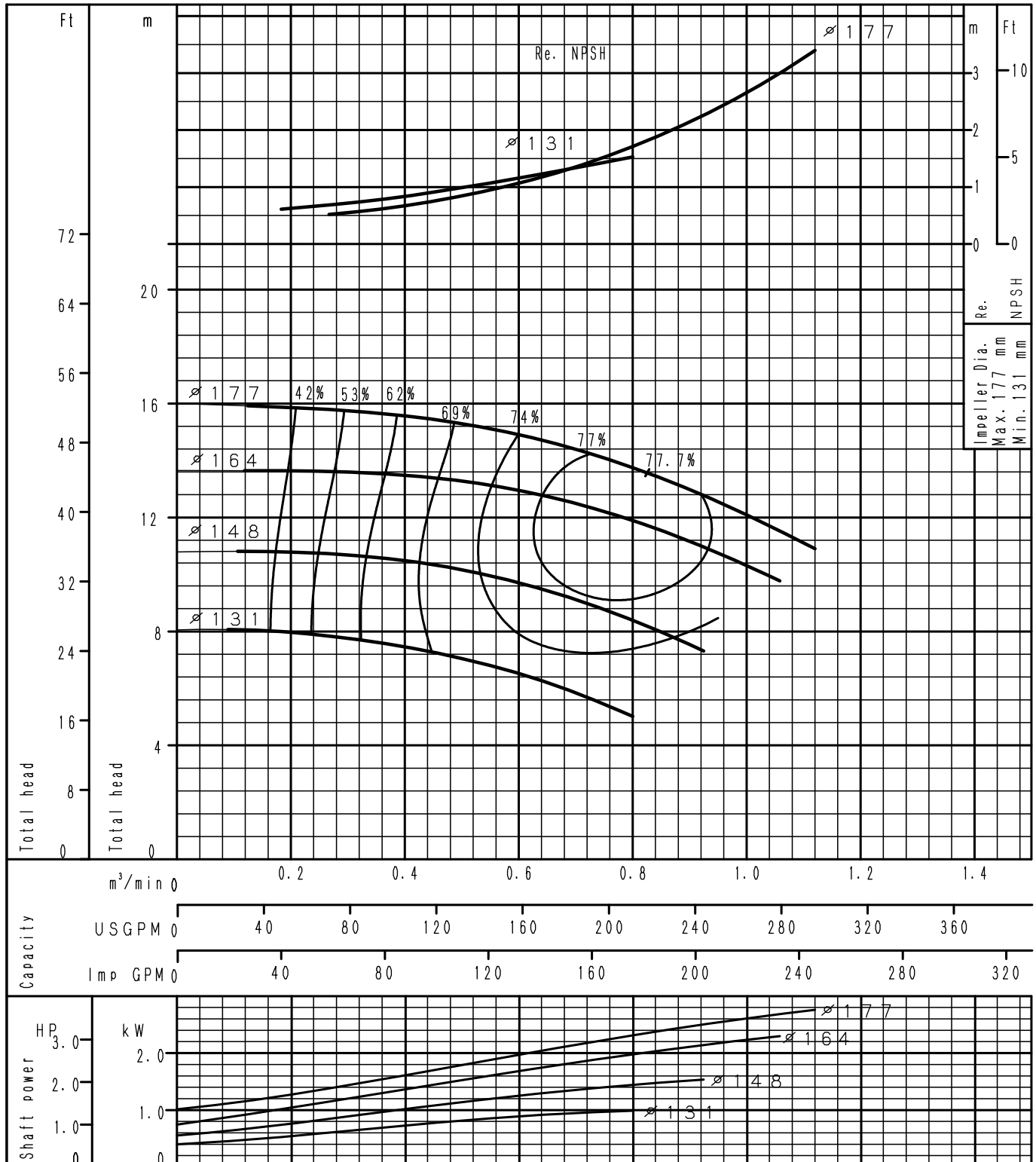

Performance Curve

4 Poles

GS50-200	According to ISO testing code 9906 Grade 3B
60Hz ( Speed 1750 min <sup>-1</sup> )	DENSITY= 1.0 kg/l , VISCOSITY= 1.0 mPa·s

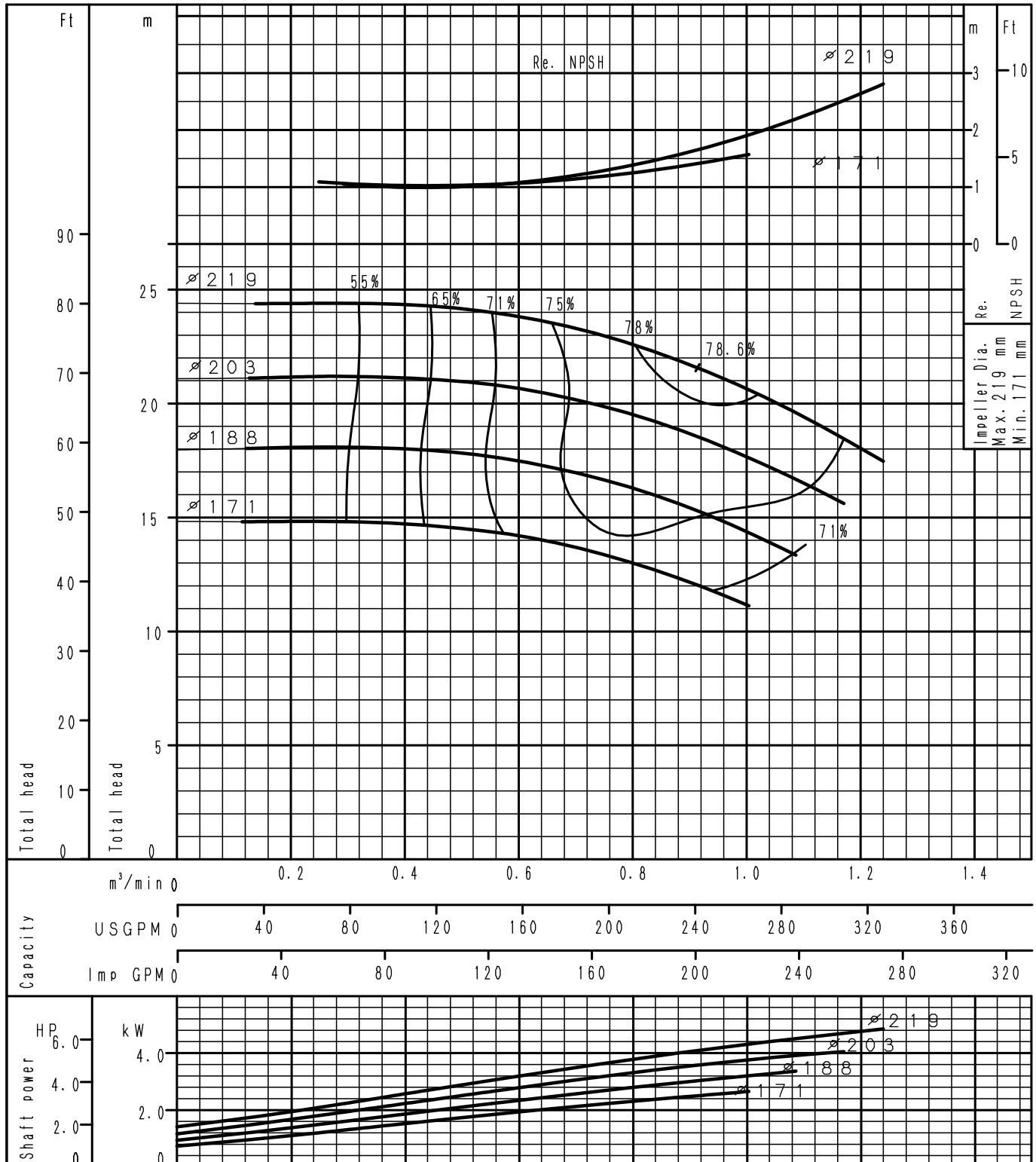

Performance Curve

4 Poles

<h1 style="margin: 0;">GS50-250</h1>	According to ISO testing code 9906 Grade 3B
60Hz ( Speed 1750 min <sup>-1</sup> )	DENSITY= 1.0 kg/l , VISCOSITY= 1.0 mPa·s

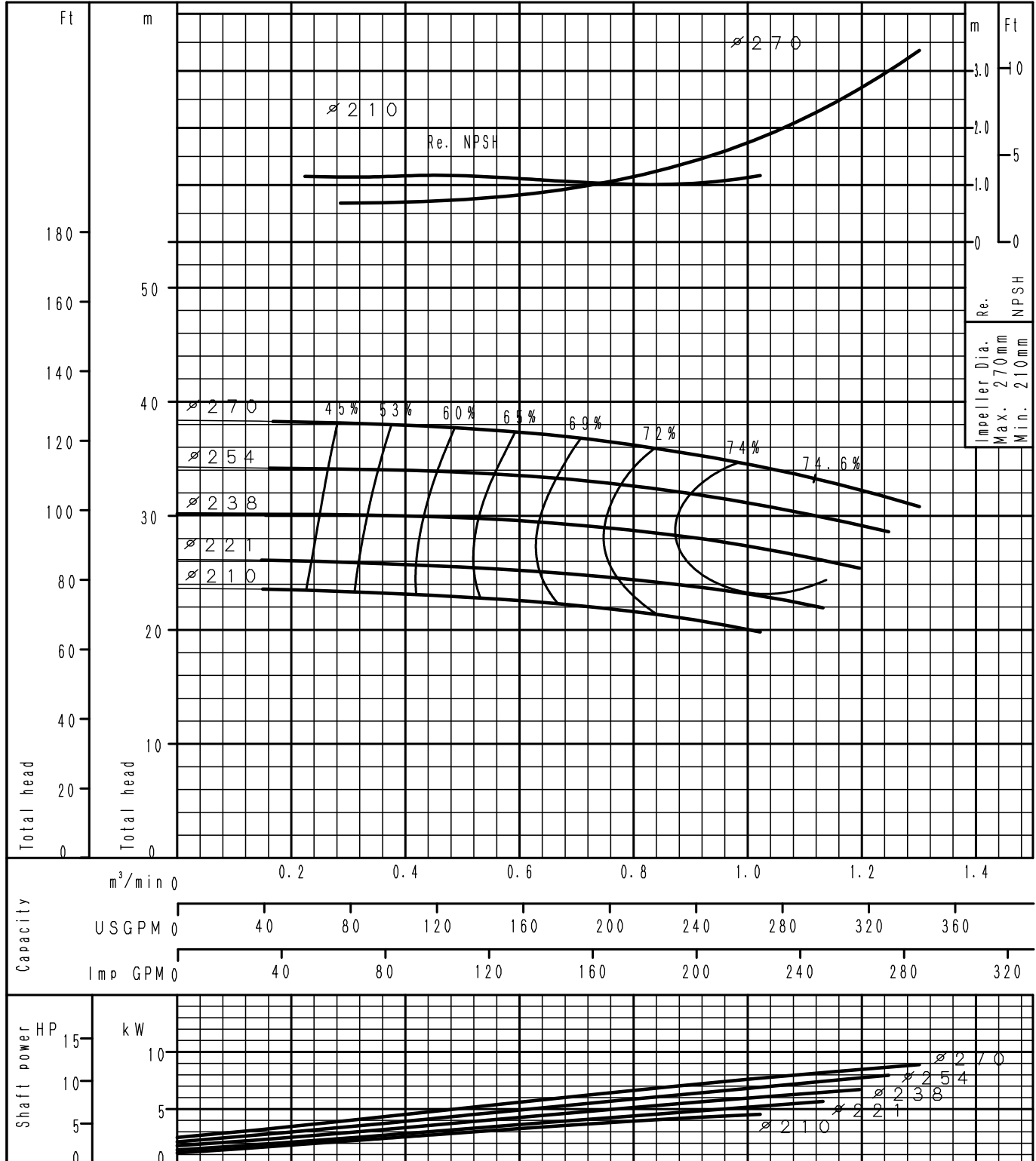



Performance Curve

4 Poles

GS50-315	According to ISO testing code 9906 Grade 3B
60Hz ( Speed 1750 min <sup>-1</sup> )	DENSITY= 1.0 kg/l , VISCOSITY= 1.0 mPa·s

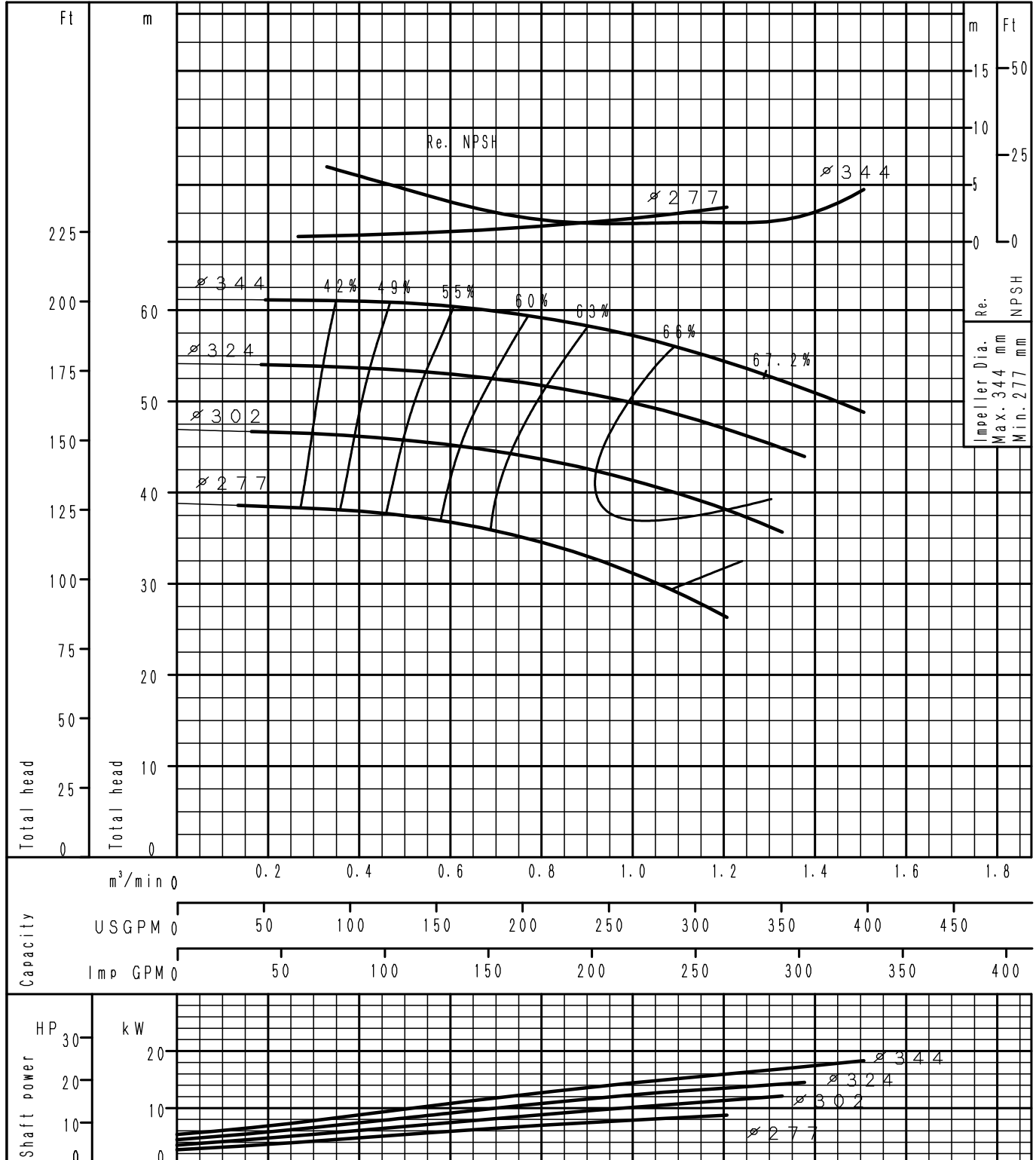

Performance Curve

4 Poles

<h1 style="margin: 0;">GS65-125</h1>	According to ISO testing code 9906 Grade 3B
60Hz ( Speed 1750 min <sup>-1</sup> )	DENSITY= 1.0 kg/l , VISCOSITY= 1.0 mPa·s

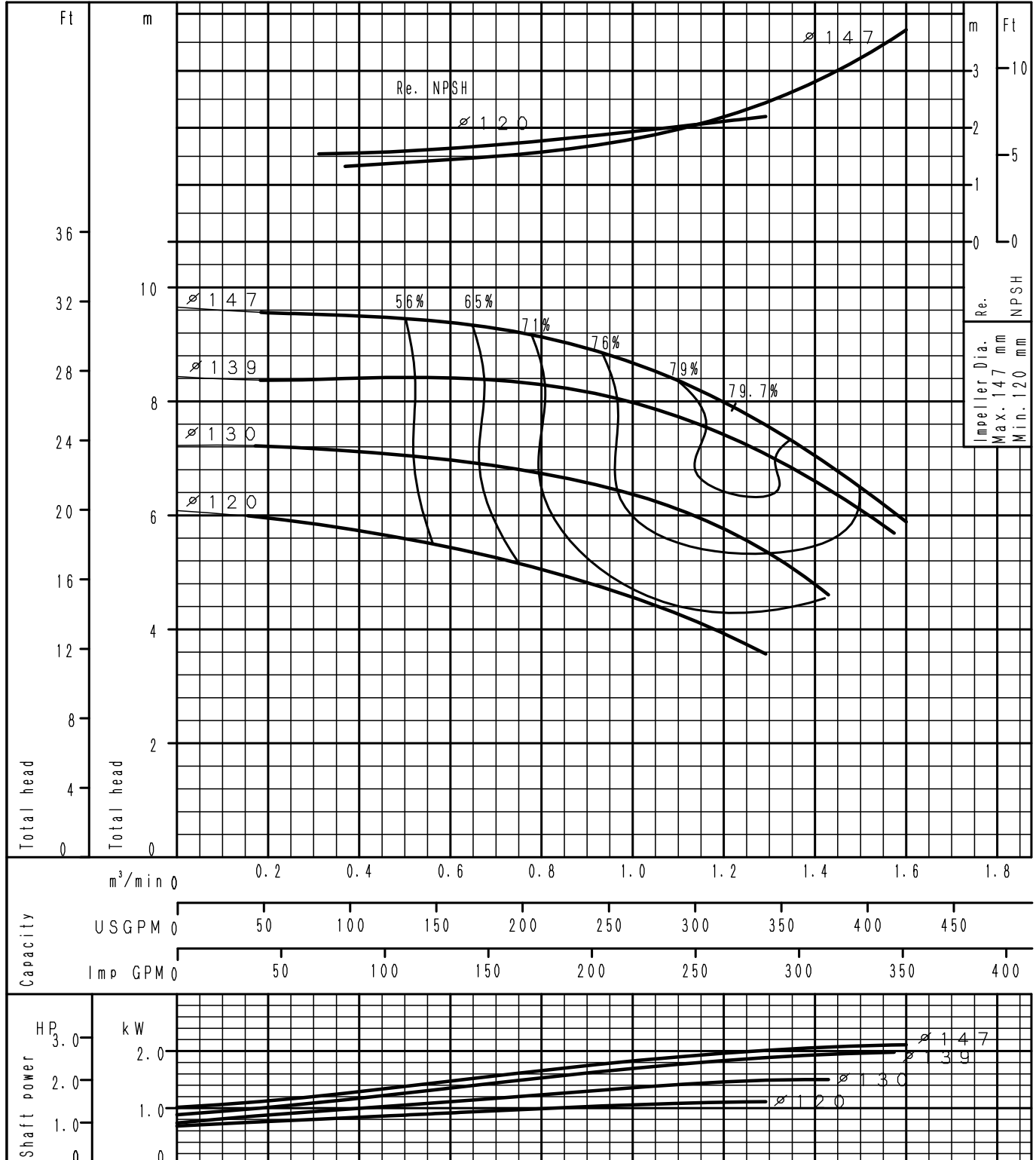

Performance Curve

4 Poles

<h1 style="margin: 0;">GS65-160</h1>	According to ISO testing code 9906 Grade 3B
60Hz ( Speed 1750 min <sup>-1</sup> )	DENSITY= 1.0 kg/l , VISCOSITY= 1.0 mPa·s

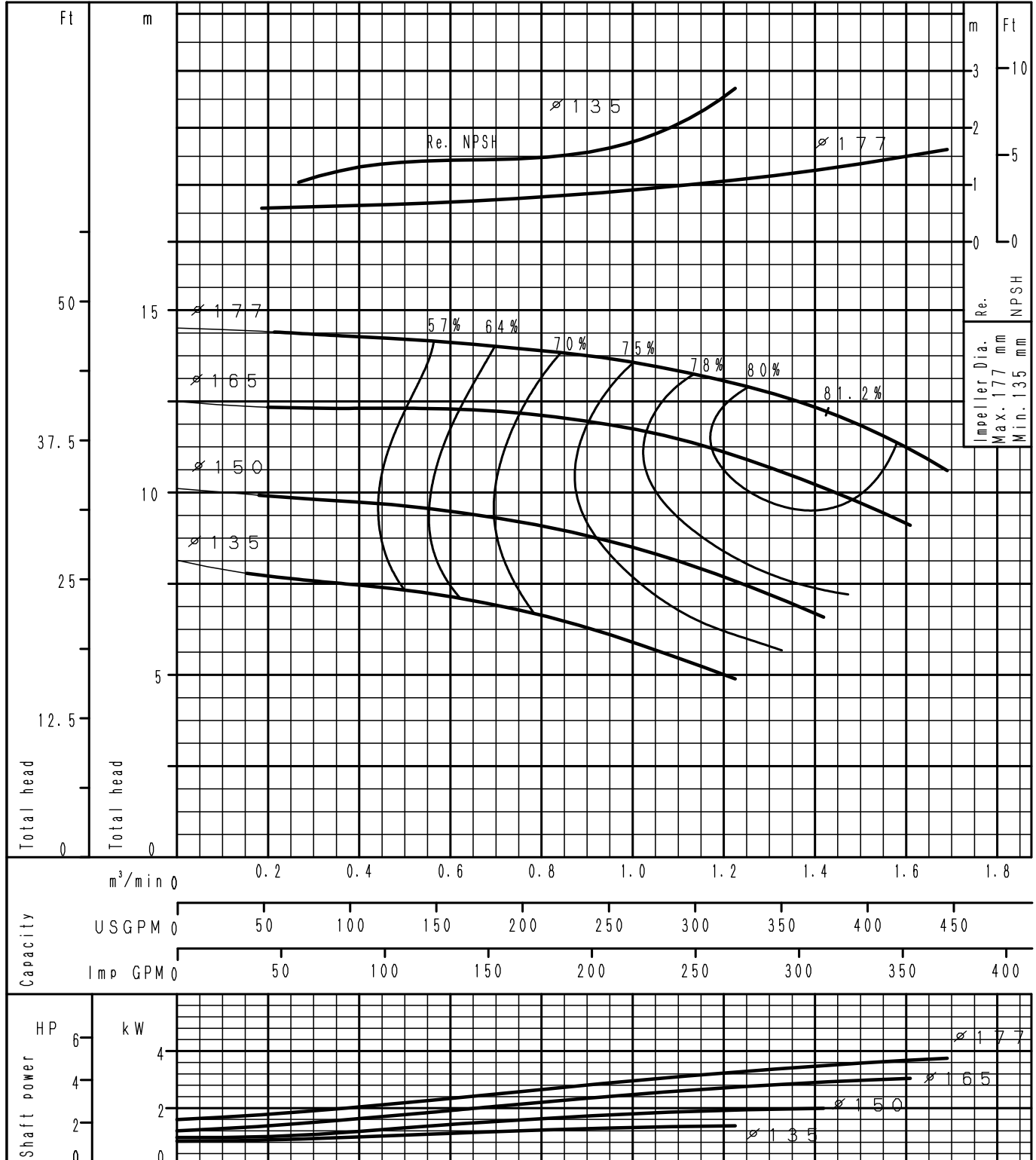

Performance Curve

4 Poles

GS65-200	According to ISO testing code 9906 Grade 3B
60Hz ( Speed 1750 min <sup>-1</sup> )	DENSITY= 1.0 kg/l , VISCOSITY= 1.0 mPa·s

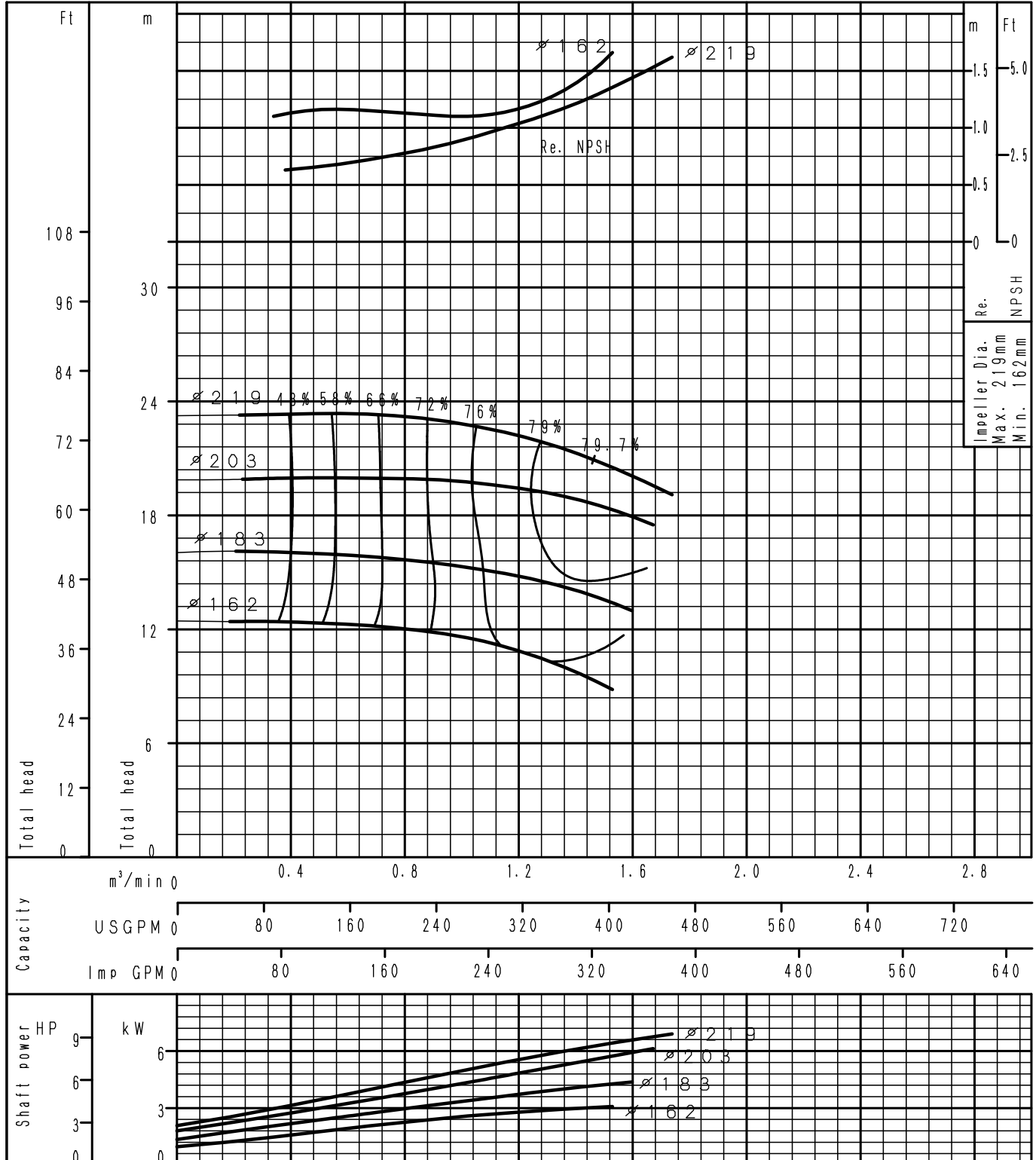

Performance Curve

4 Poles

GS65-250	According to ISO testing code 9906 Grade 3B
60Hz ( Speed 1750 min <sup>-1</sup> )	DENSITY= 1.0 kg/l , VISCOSITY= 1.0 mPa·s

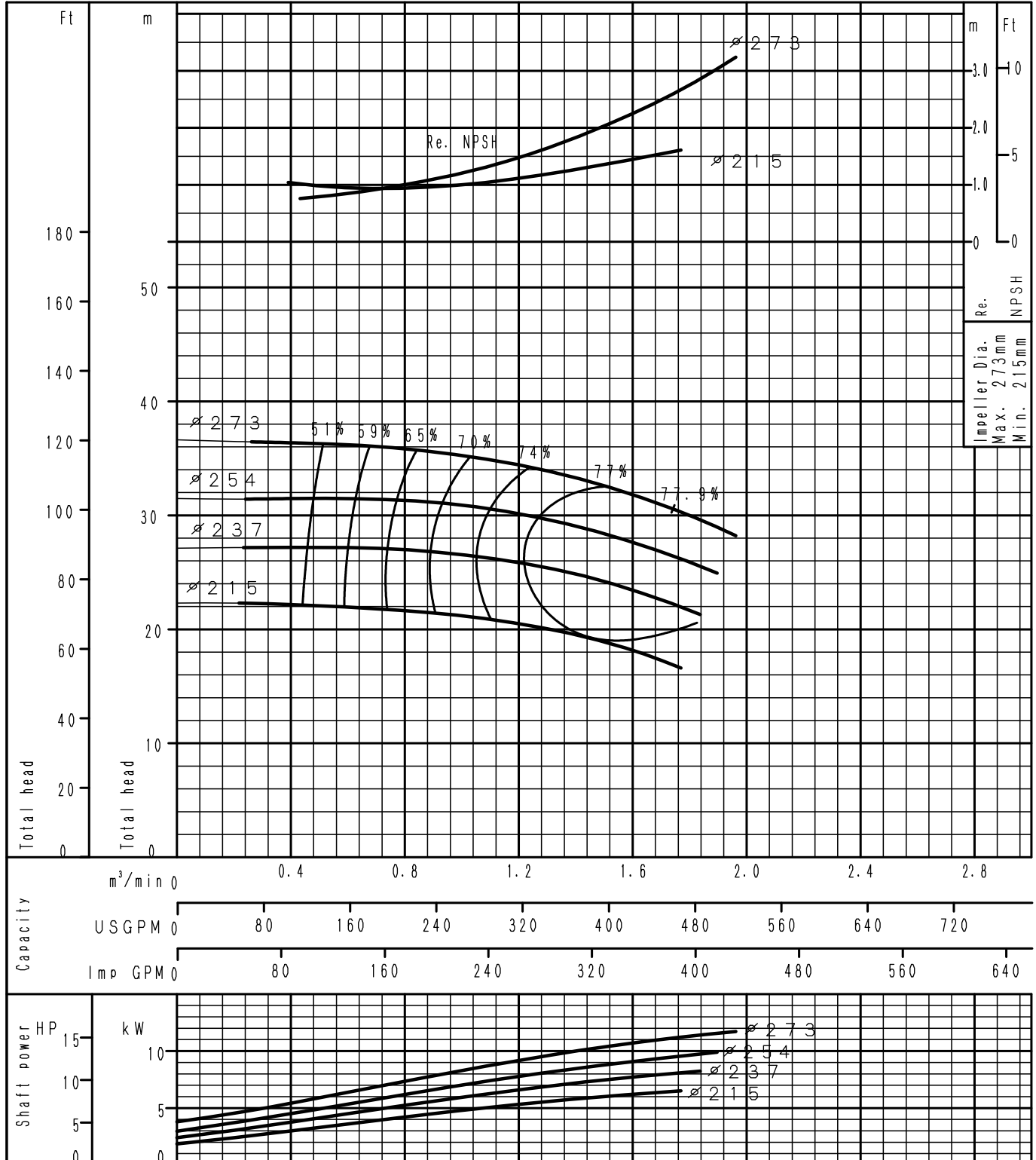

Performance Curve

4 Poles

GS65-315	According to ISO testing code 9906 Grade 3B
60Hz ( Speed 1750 min <sup>-1</sup> )	DENSITY= 1.0 kg/l , VISCOSITY= 1.0 mPa·s

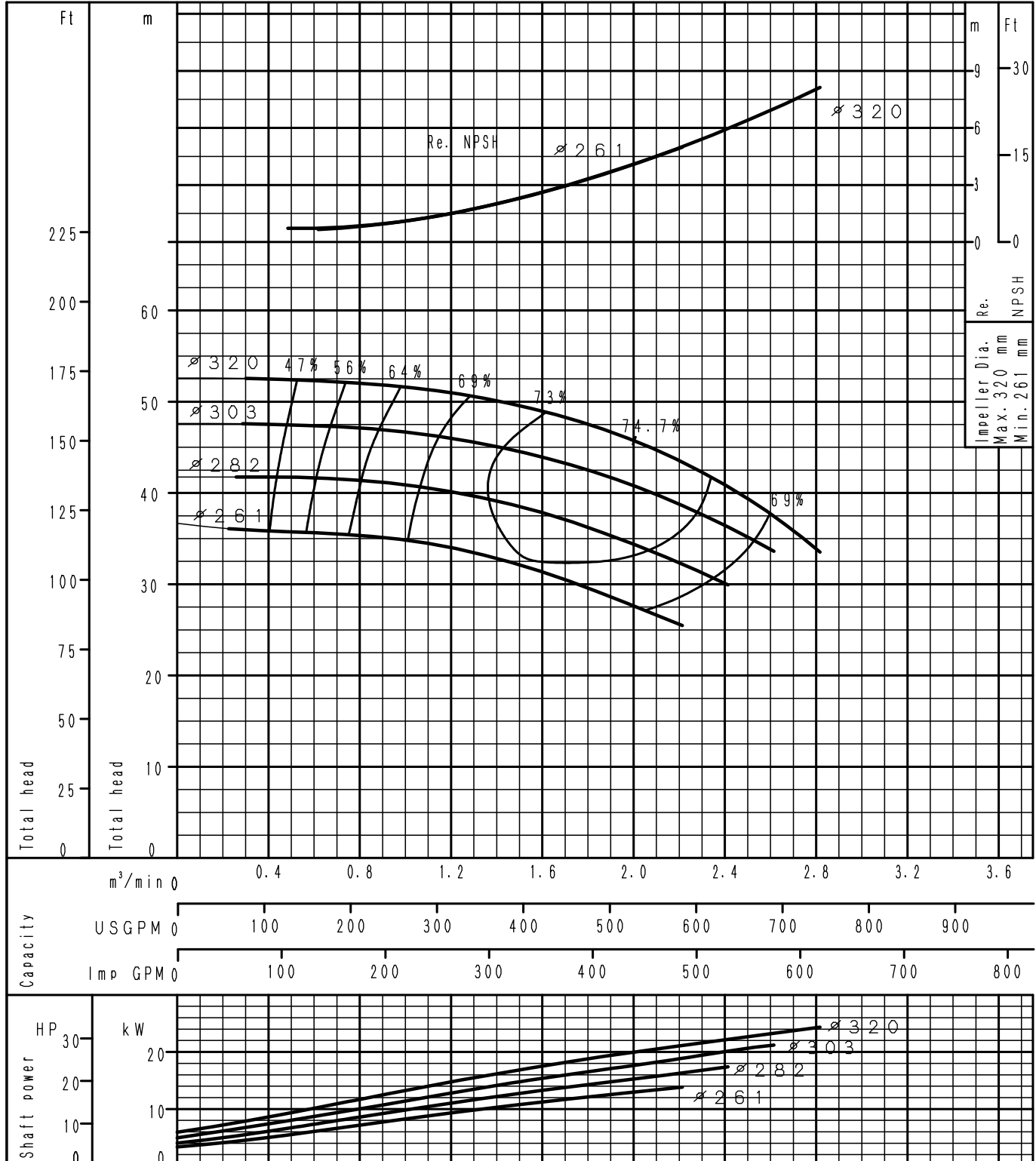

Performance Curve

4 Poles

GS80-160	According to ISO testing code 9906 Grade 3B
60Hz ( Speed 1750 min <sup>-1</sup> )	DENSITY= 1.0 kg/l , VISCOSITY= 1.0 mPa·s

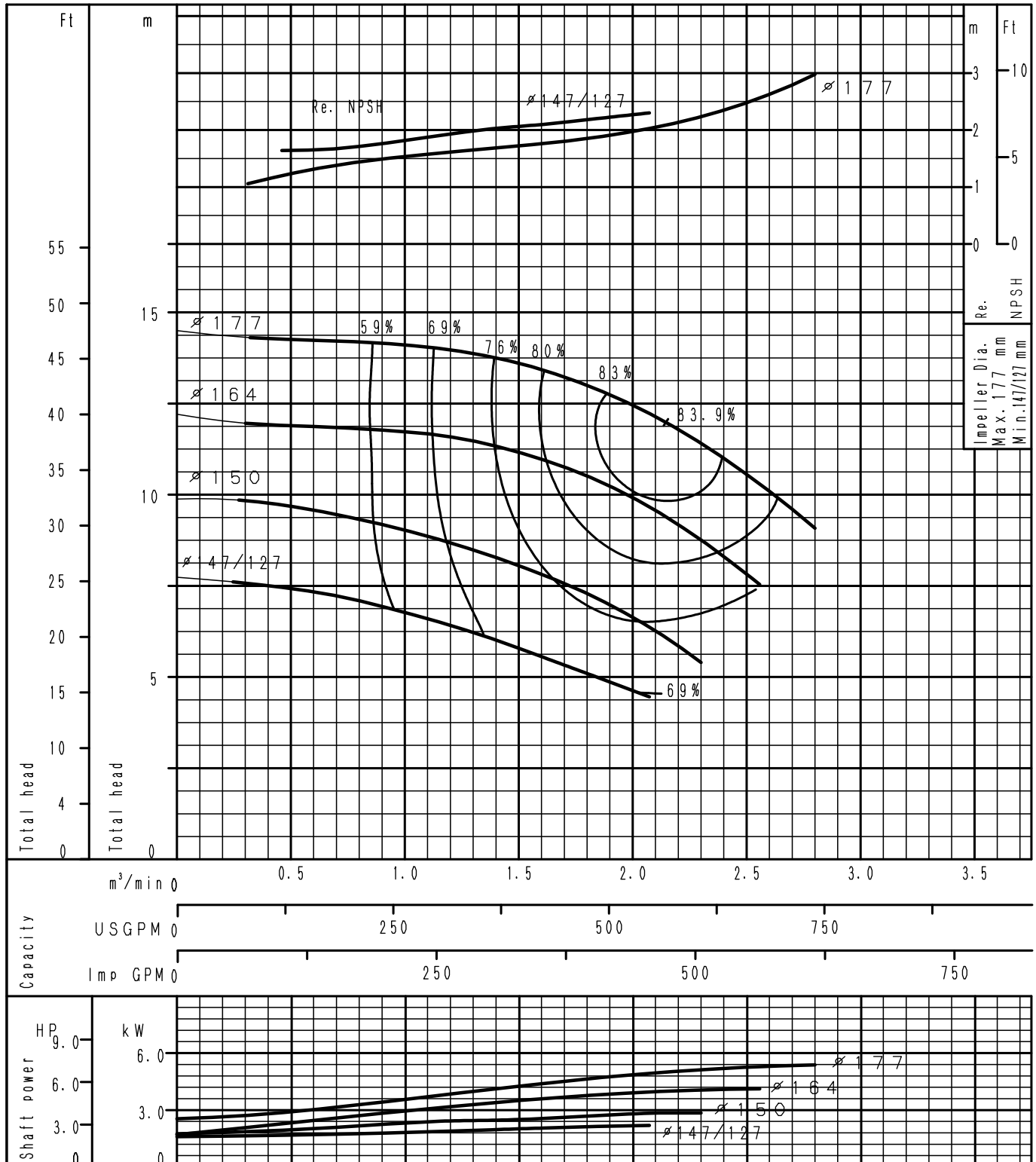

Performance Curve

4 Poles

GS80-200	According to ISO testing code 9906 Grade 3B
60Hz ( Speed 1750 min <sup>-1</sup> )	DENSITY= 1.0 kg/l , VISCOSITY= 1.0 mPa·s

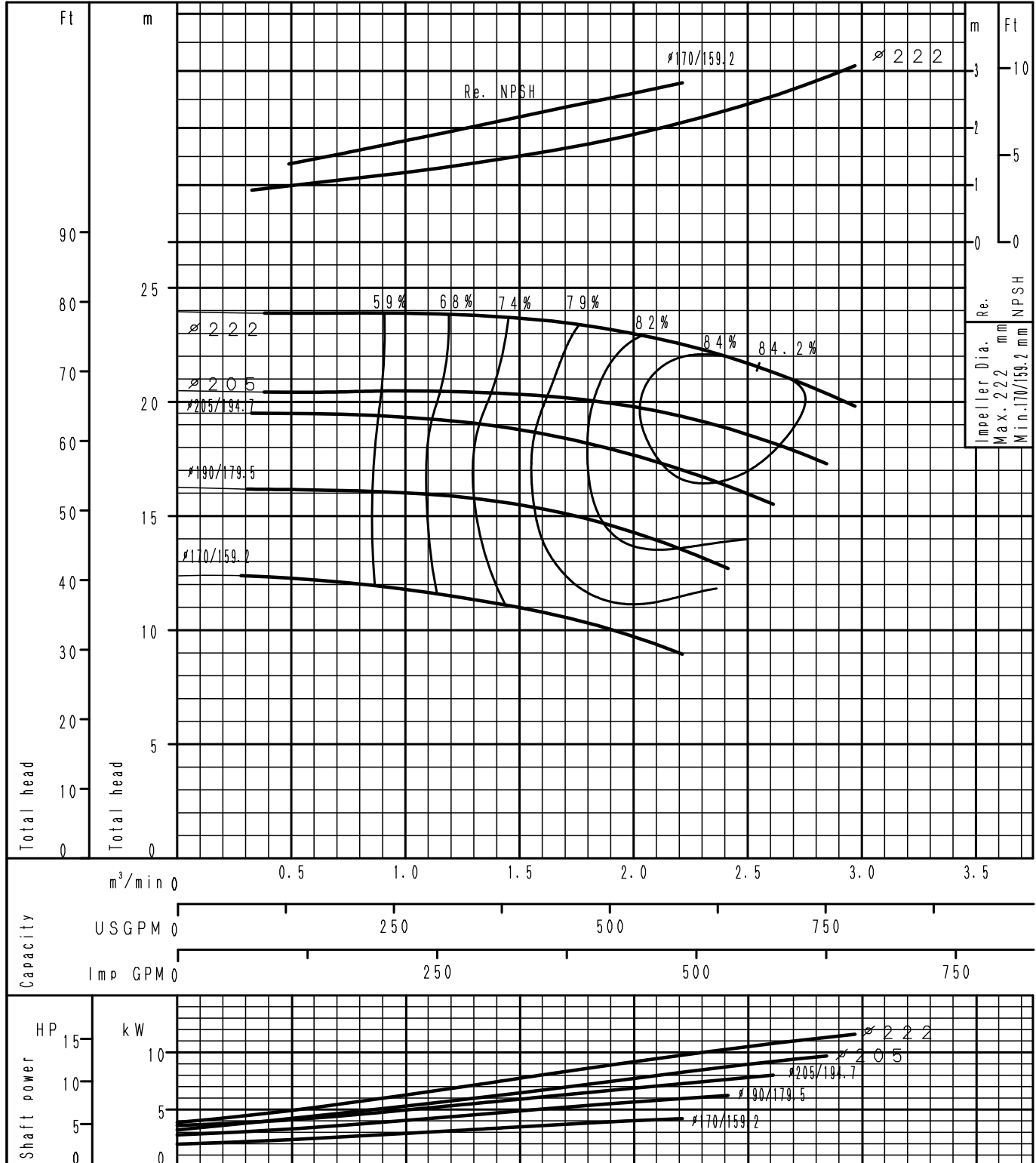



Performance Curve

4 Poles

GS80-250	According to ISO testing code 9906 Grade 3B
60Hz ( Speed 1750 min <sup>-1</sup> )	DENSITY= 1.0 kg/l , VISCOSITY= 1.0 mPa·s

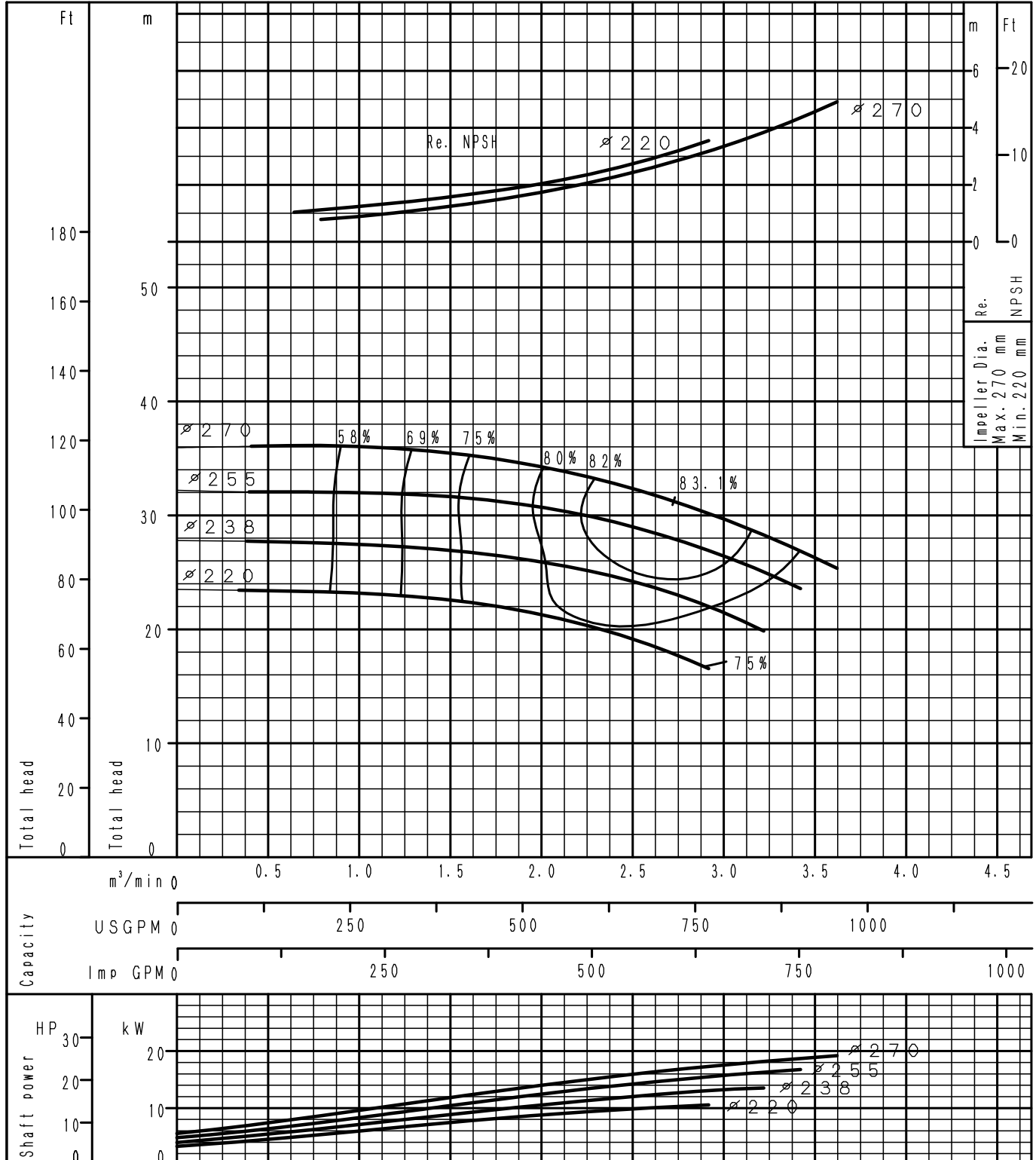

Performance Curve

4 Poles

<h1 style="margin: 0;">GS80-315</h1>	According to ISO testing code 9906 Grade 3B
60Hz ( Speed 1750 min <sup>-1</sup> )	DENSITY= 1.0 kg/l , VISCOSITY= 1.0 mPa·s

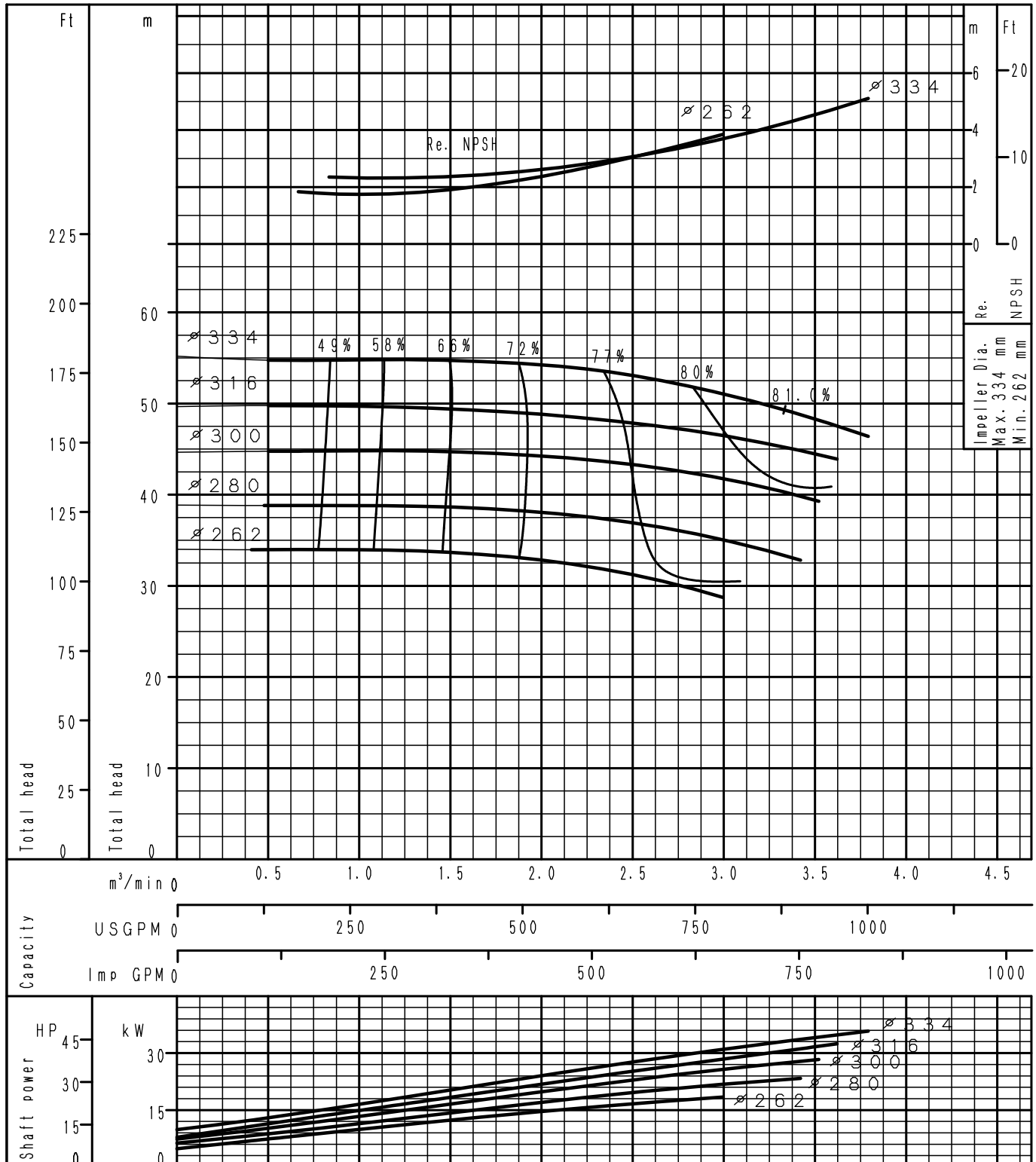

Performance Curve

4 Poles

GS80-400	According to ISO testing code 9906 Grade 3B
60Hz ( Speed 1750 min <sup>-1</sup> )	DENSITY= 1.0 kg/l , VISCOSITY= 1.0 mPa·s

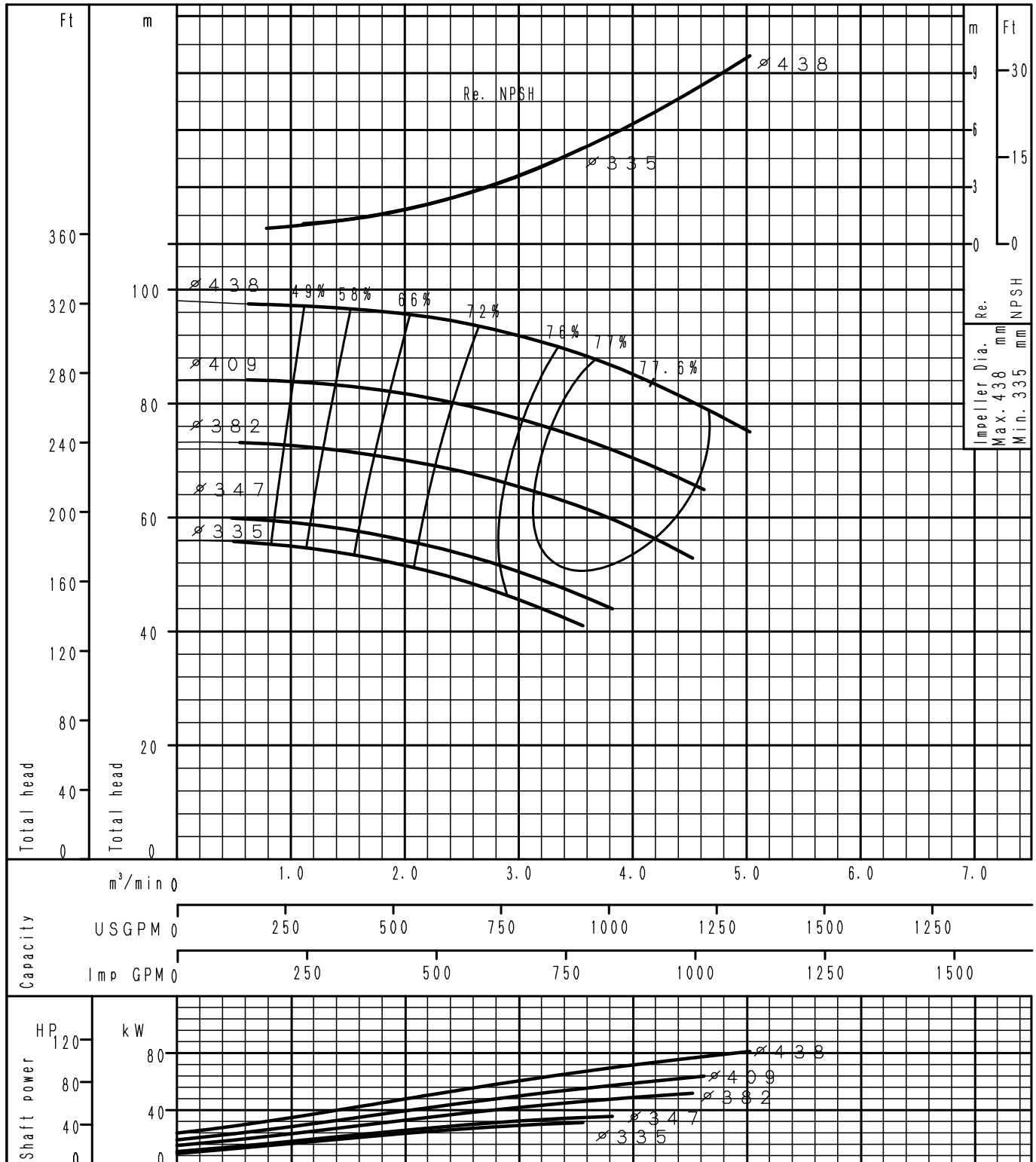

Performance Curve

4 Poles

GS100-160	According to ISO testing code 9906 Grade 3B
60Hz ( Speed 1750 min <sup>-1</sup> )	DENSITY= 1.0 kg/l , VISCOSITY= 1.0 mPa·s

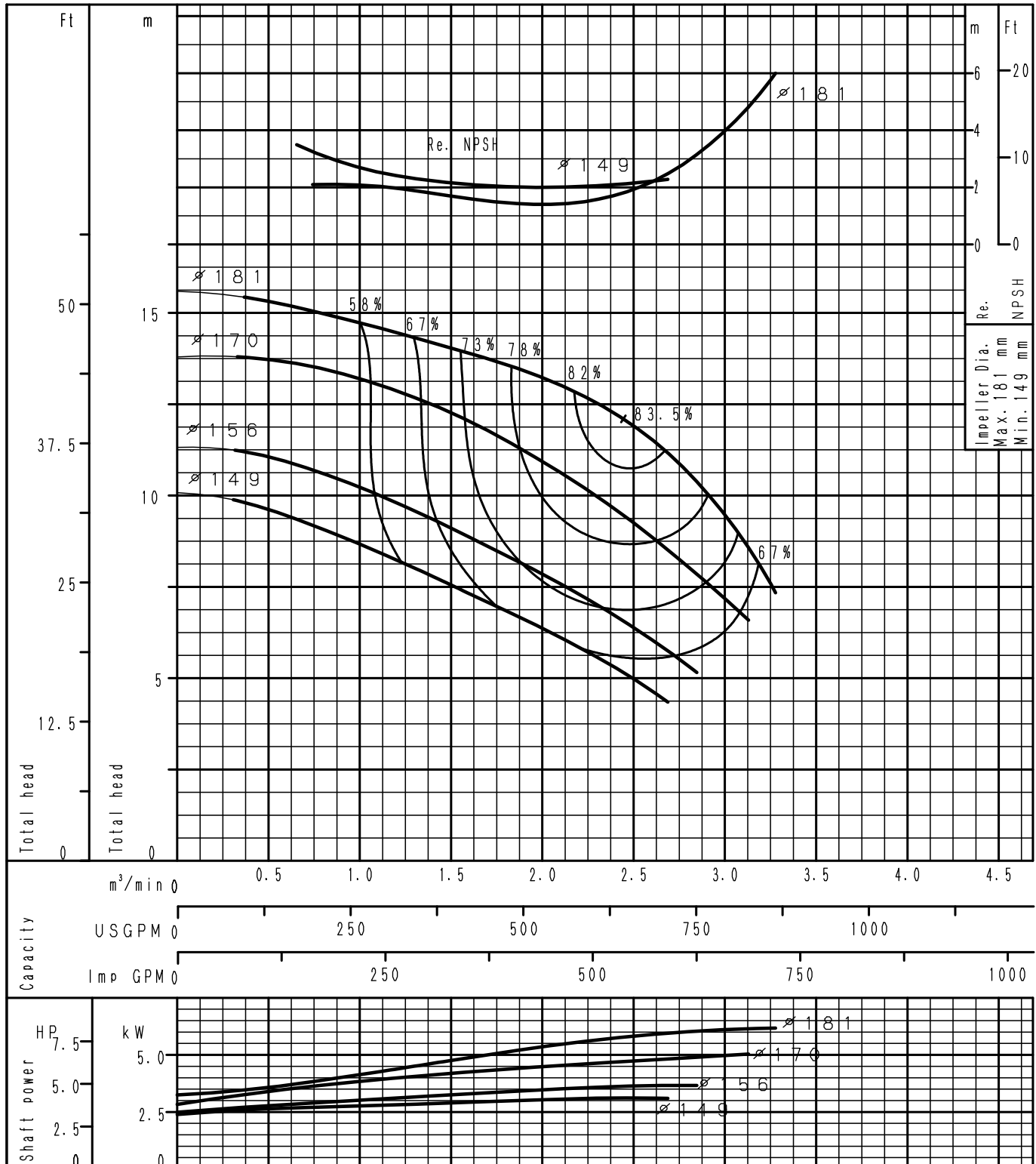

Performance Curve

4 Poles

GS100-200	According to ISO testing code 9906 Grade 3B
60Hz ( Speed 1750 min <sup>-1</sup> )	DENSITY= 1.0 kg/l , VISCOSITY= 1.0 mPa·s

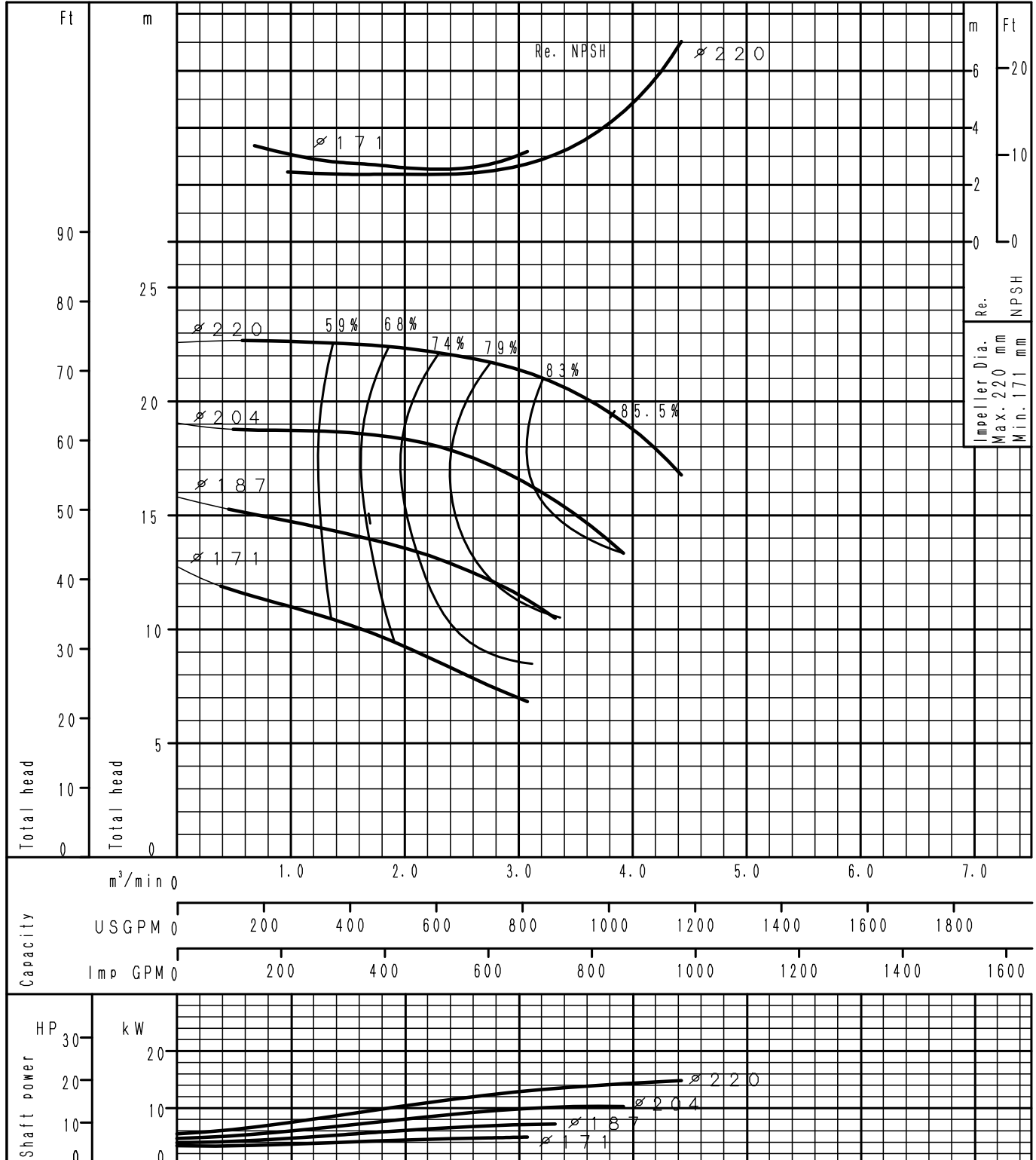

Performance Curve

4 Poles

GS100-250	According to ISO testing code 9906 Grade 3B
60Hz ( Speed 1750 min <sup>-1</sup> )	DENSITY= 1.0 kg/l , VISCOSITY= 1.0 mPa·s

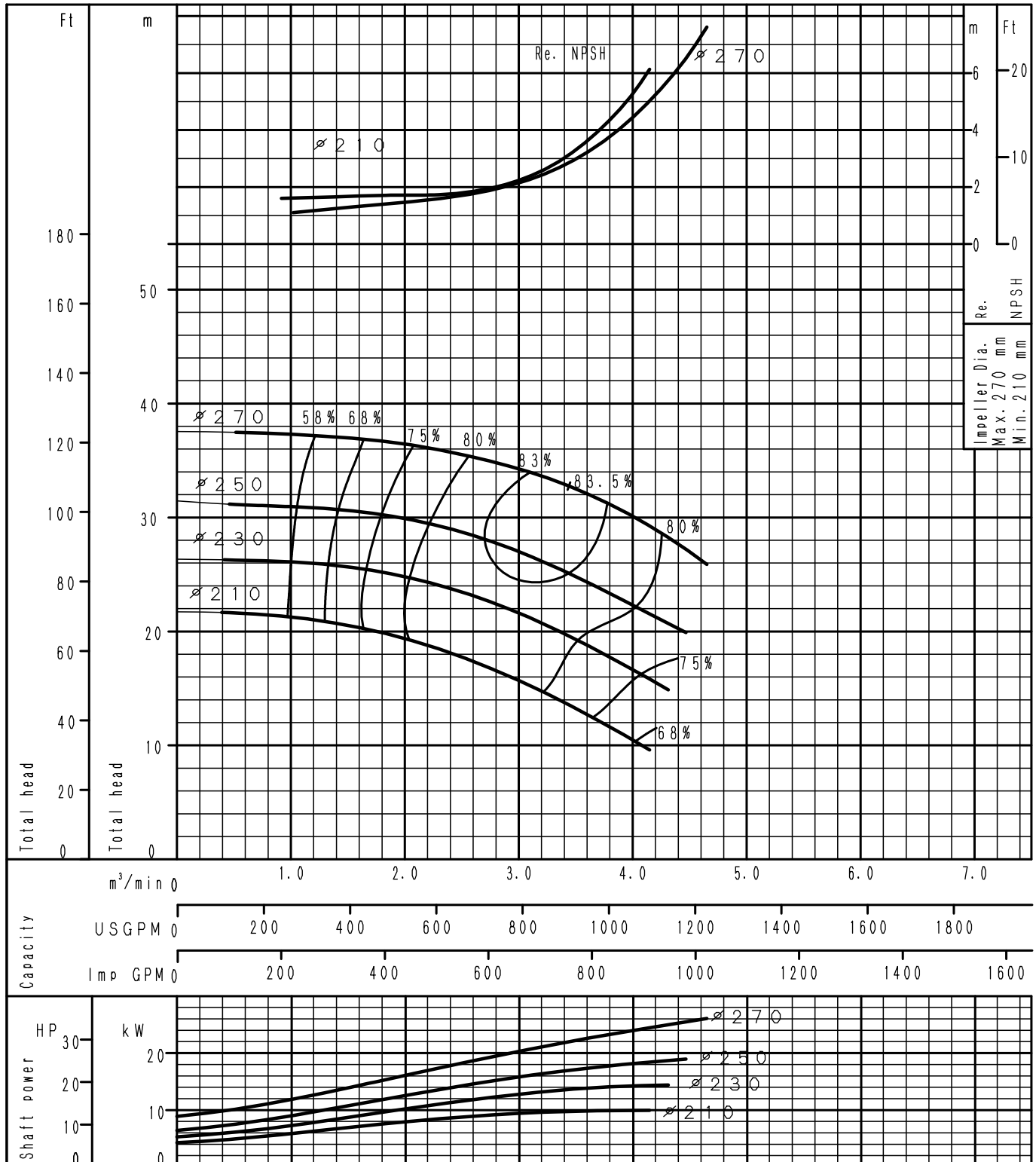

Performance Curve

4 Poles

GS100-315	According to ISO testing code 9906 Grade 3B
60Hz ( Speed 1750 min <sup>-1</sup> )	DENSITY= 1.0 kg/l , VISCOSITY= 1.0 mPa·s

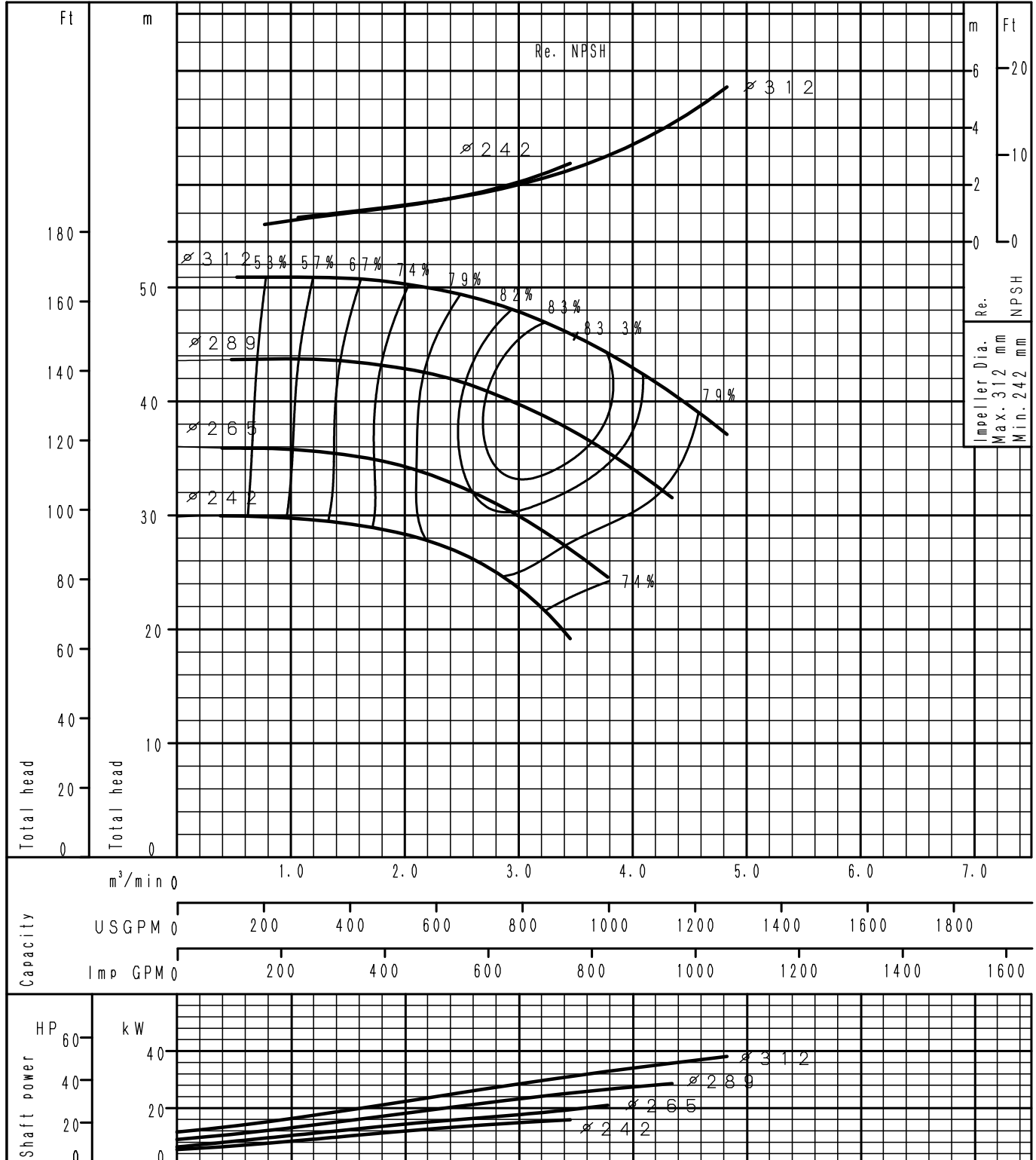

Performance Curve

4 Poles

GS100-400	According to ISO testing code 9906 Grade 3B
60Hz ( Speed 1750 min <sup>-1</sup> )	DENSITY= 1.0 kg/l , VISCOSITY= 1.0 mPa·s

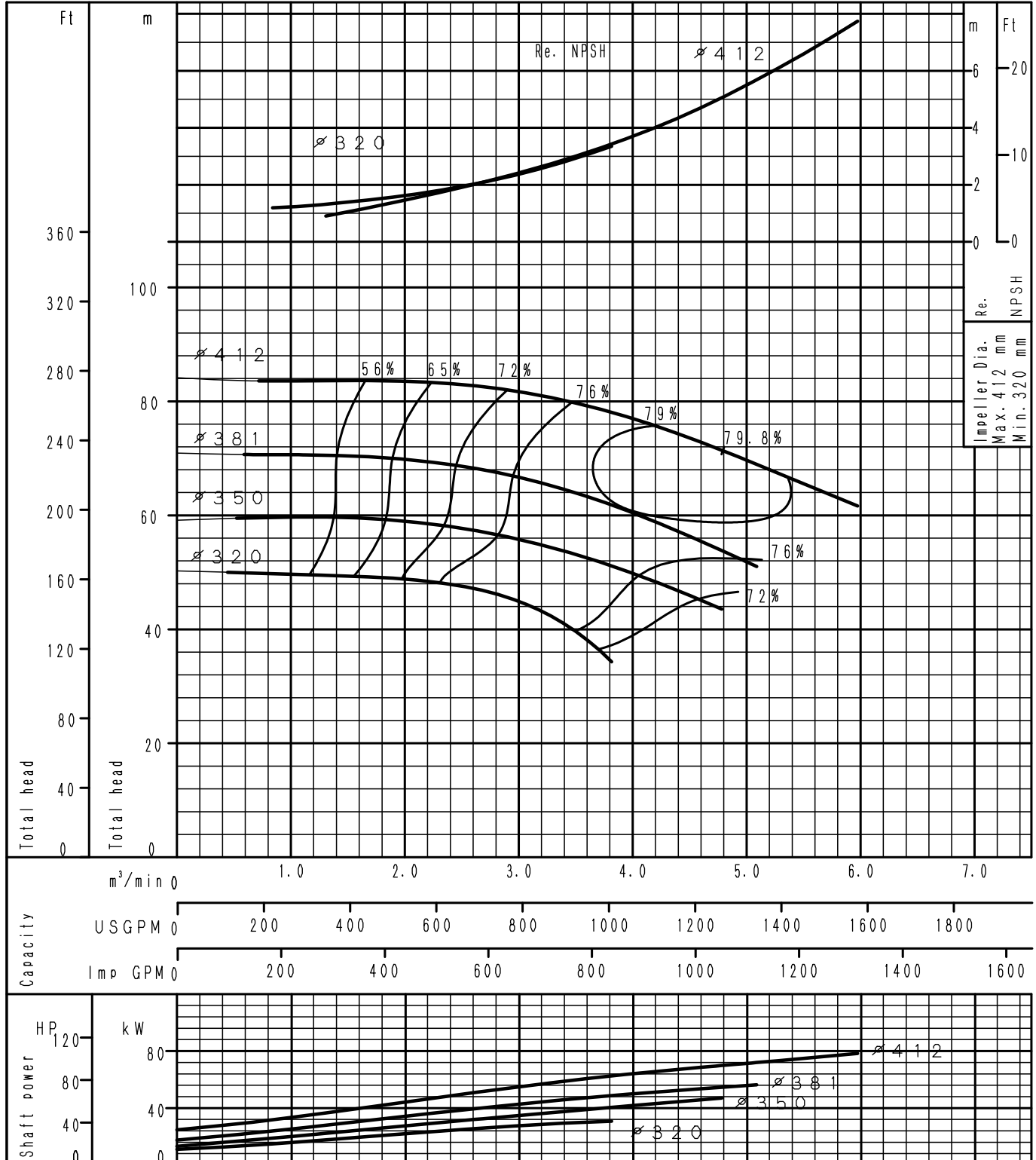



Performance Curve

4 Poles

GS125-200	According to ISO testing code 9906 Grade 3B
60Hz ( Speed 1750 min <sup>-1</sup> )	DENSITY= 1.0 kg/l , VISCOSITY= 1.0 mPa·s

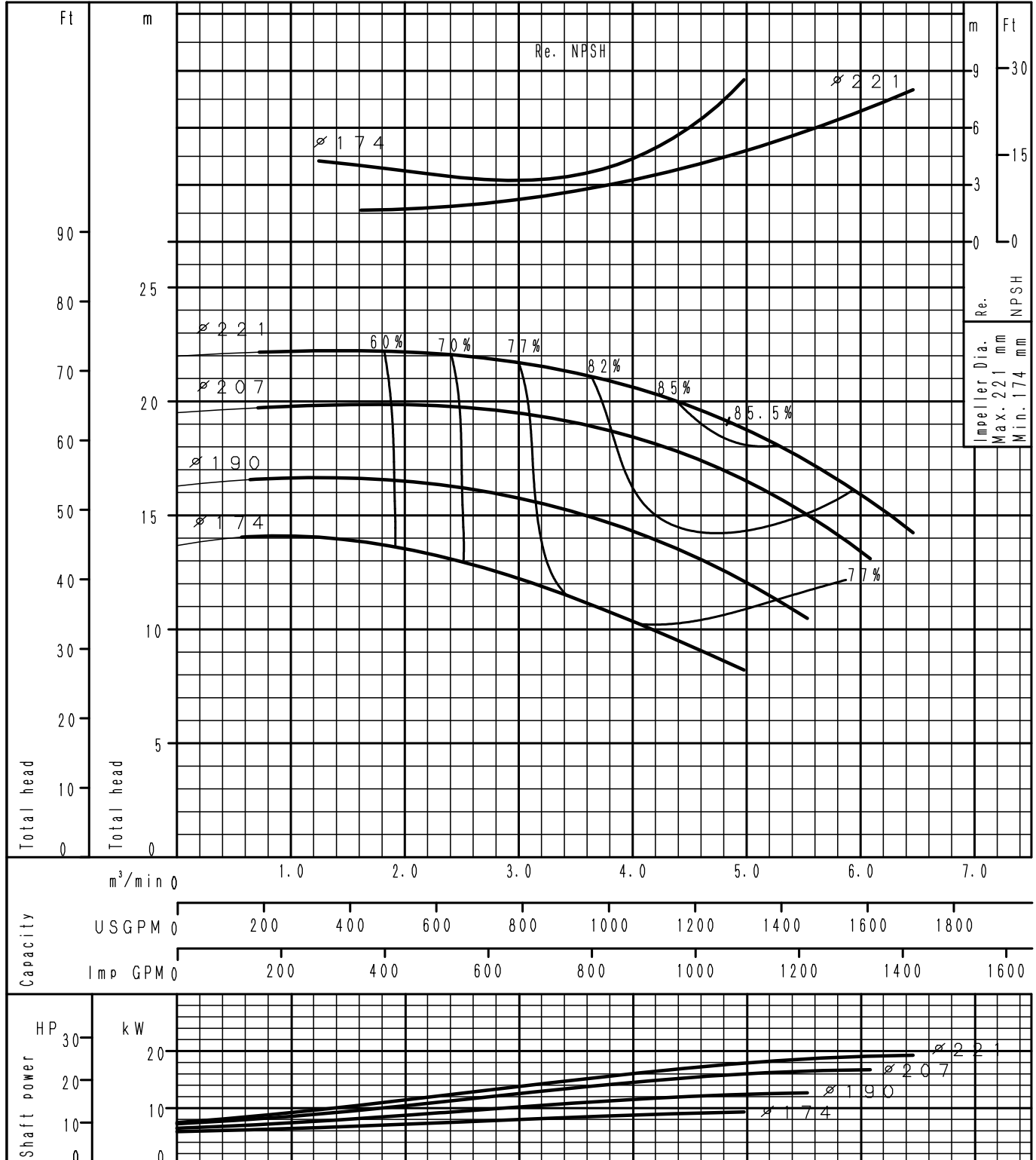

Performance Curve

4 Poles

GS125-250	According to ISO testing code 9906 Grade 3B
60Hz ( Speed 1750 min <sup>-1</sup> )	DENSITY= 1.0 kg/l , VISCOSITY= 1.0 mPa·s

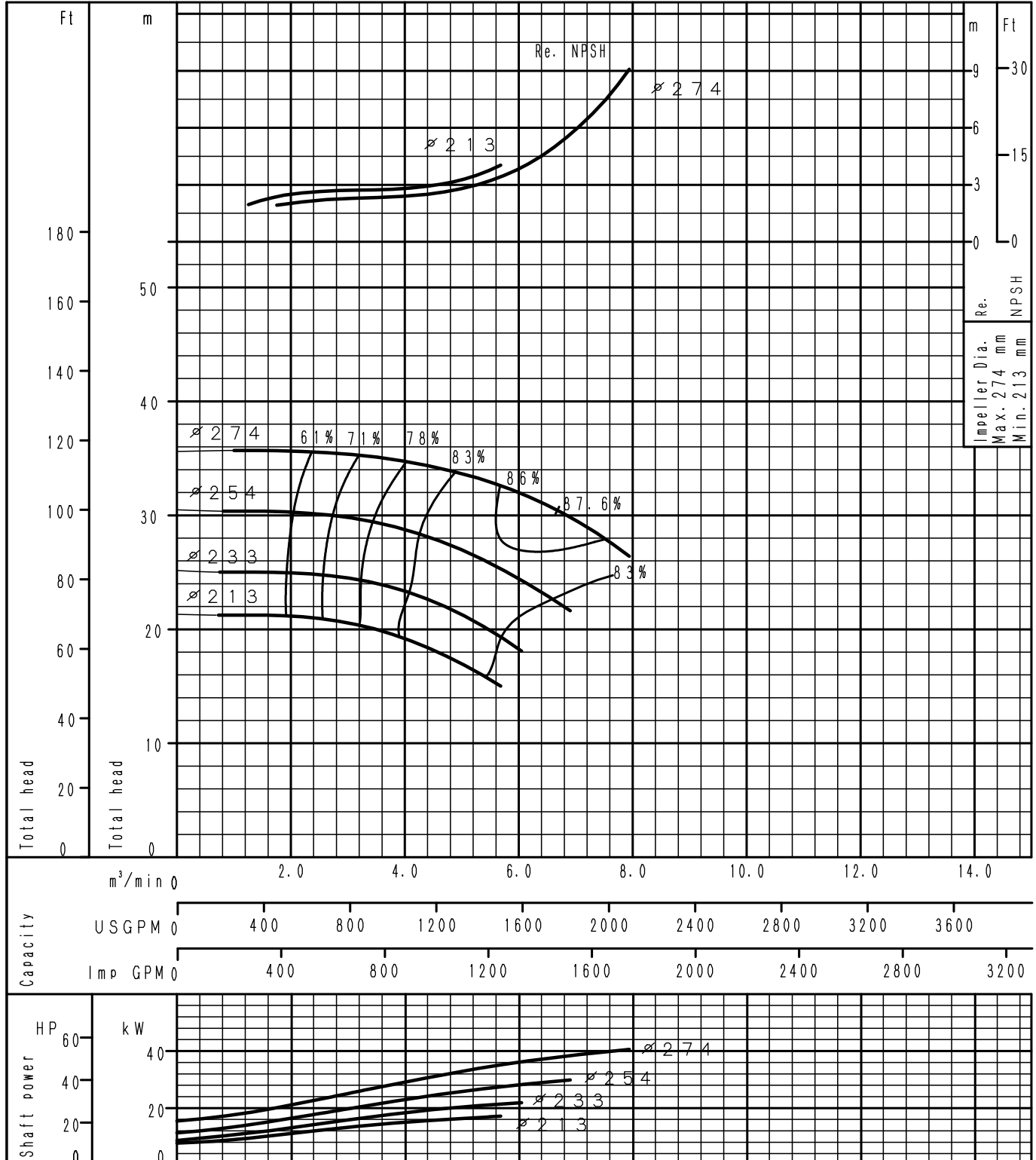

Performance Curve

4 Poles

GS125-315	According to ISO testing code 9906 Grade 3B
60Hz ( Speed 1750 min <sup>-1</sup> )	DENSITY= 1.0 kg/l , VISCOSITY= 1.0 mPa·s

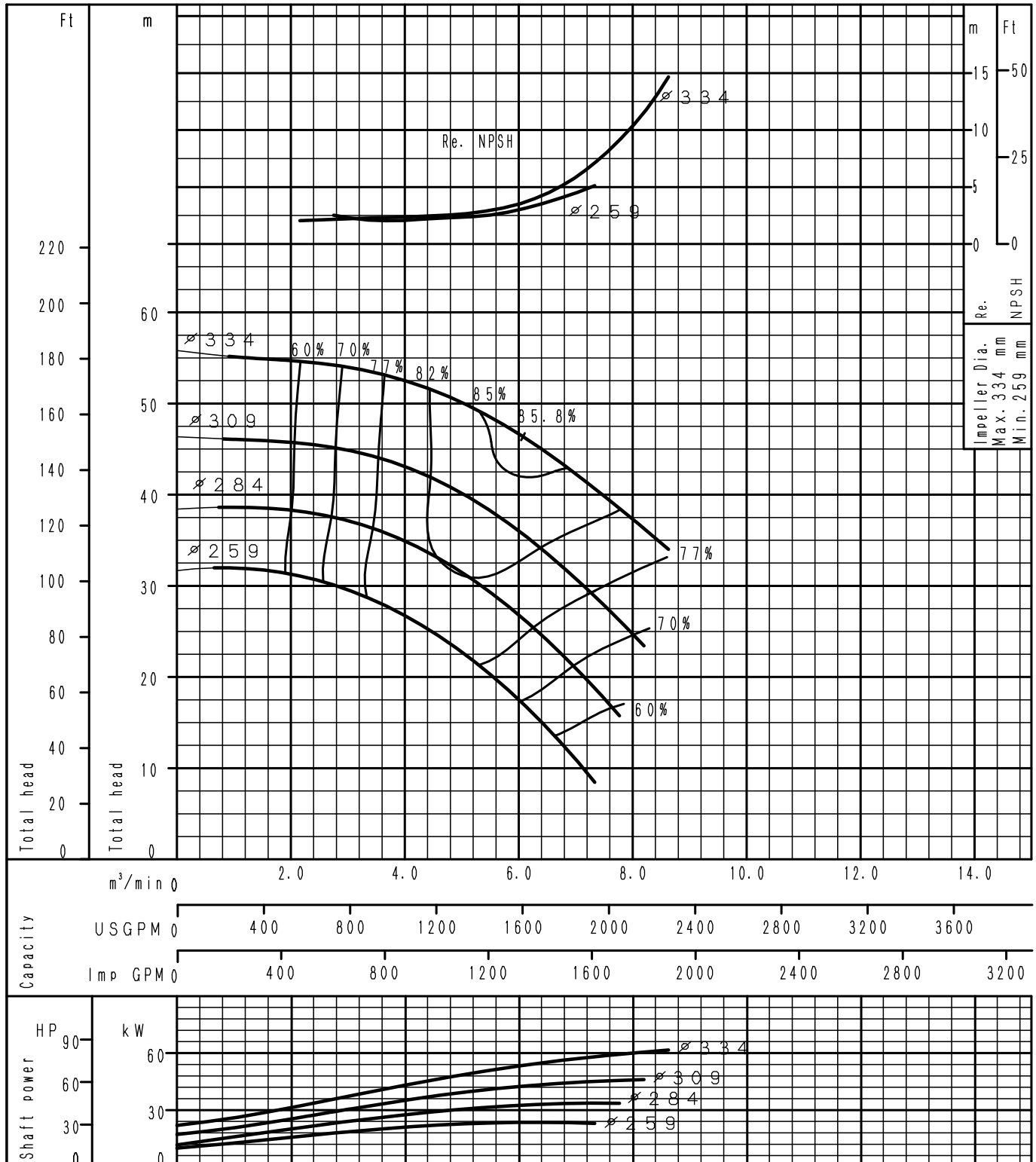

Performance Curve

4 Poles

GS125-400	According to ISO testing code 9906 Grade 3B
60Hz ( Speed 1750 min <sup>-1</sup> )	DENSITY= 1.0 kg/l , VISCOSITY= 1.0 mPa·s

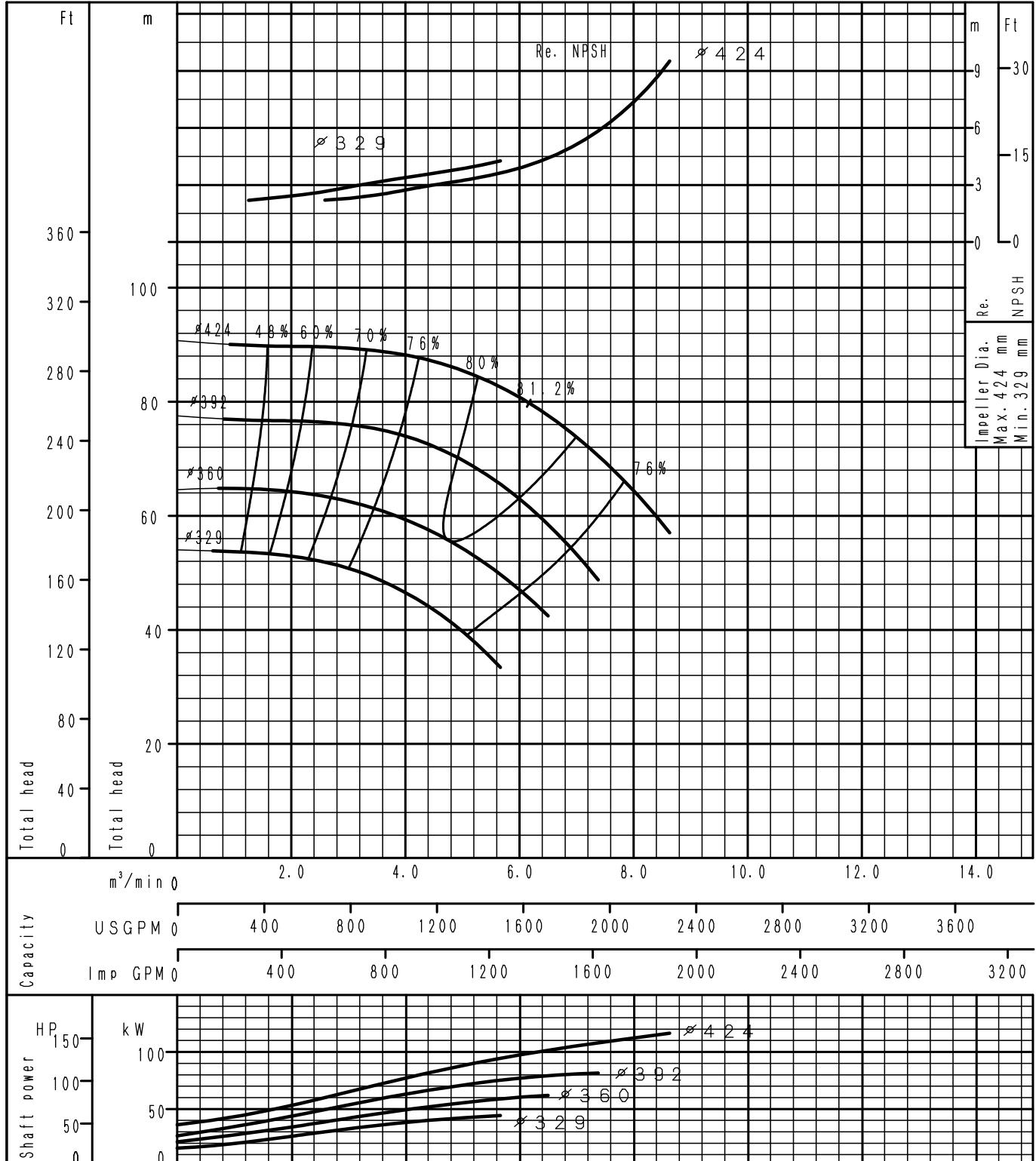

Performance Curve

4 Poles

GS125-500	According to ISO testing code 9906 Grade 3B
60Hz ( Speed 1750 min <sup>-1</sup> )	DENSITY= 1.0 kg/l , VISCOSITY= 1.0 mPa·s

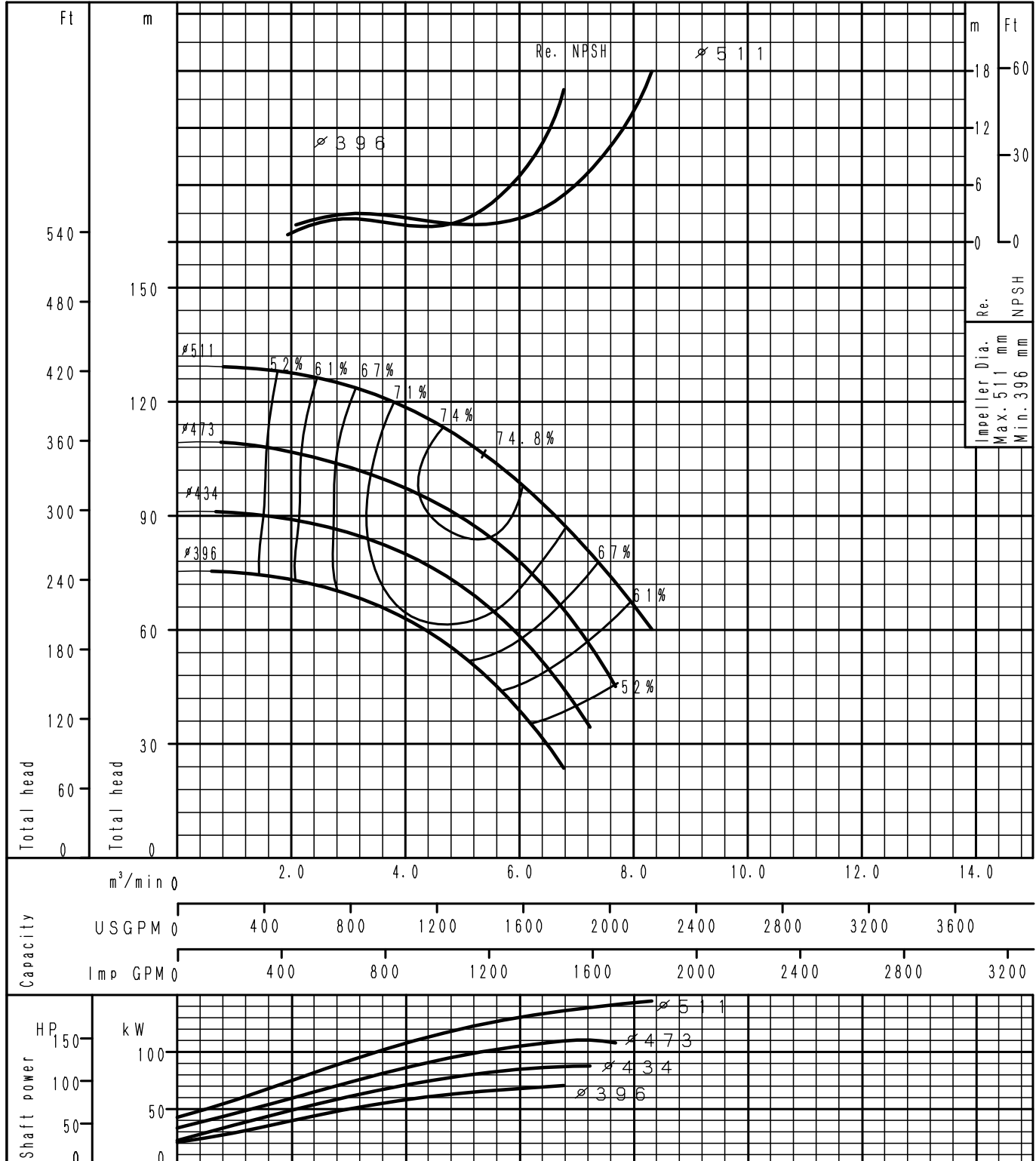

Performance Curve

4 Poles

GS150-200	According to ISO testing code 9906 Grade 3B
60Hz ( Speed 1750 min <sup>-1</sup> )	DENSITY= 1.0 kg/l , VISCOSITY= 1.0 mPa·s

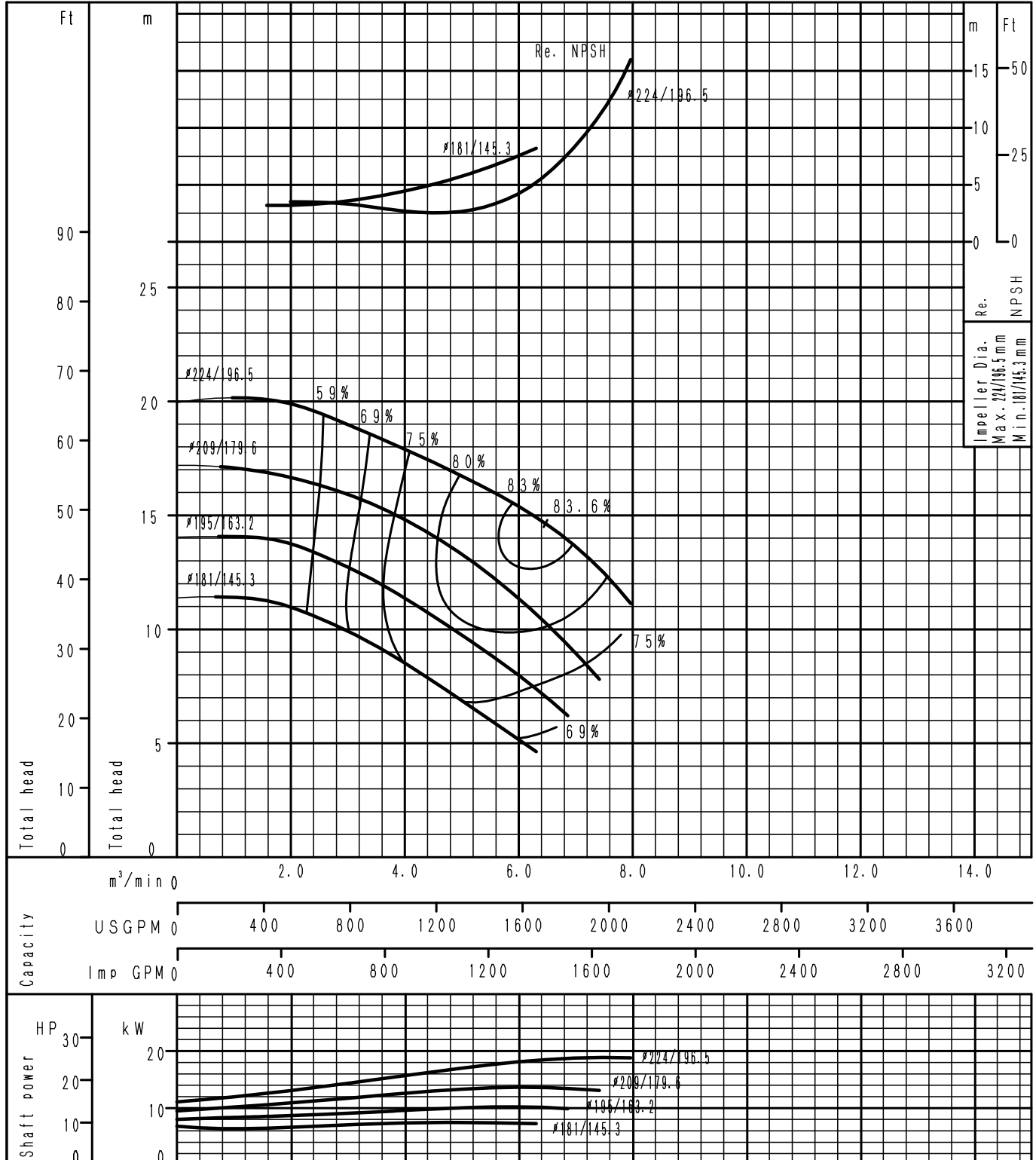

Performance Curve

4 Poles

GS150-250	According to ISO testing code 9906 Grade 3B
60Hz ( Speed 1750 min <sup>-1</sup> )	DENSITY= 1.0 kg/l , VISCOSITY= 1.0 mPa·s

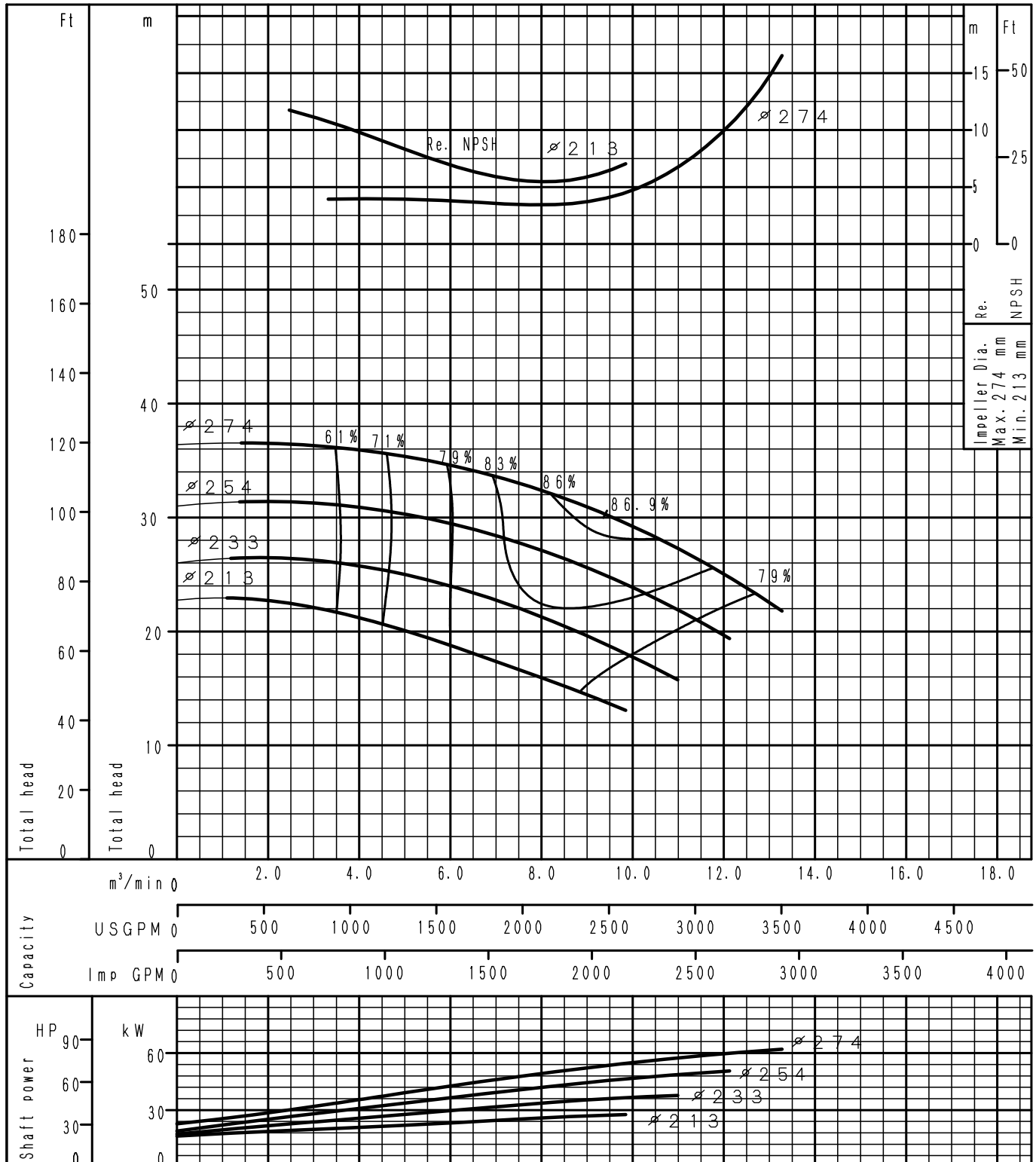

Performance Curve

4 Poles

GS150-315	According to ISO testing code 9906 Grade 3B
60Hz ( Speed 1750 min <sup>-1</sup> )	DENSITY= 1.0 kg/l , VISCOSITY= 1.0 mPa.s

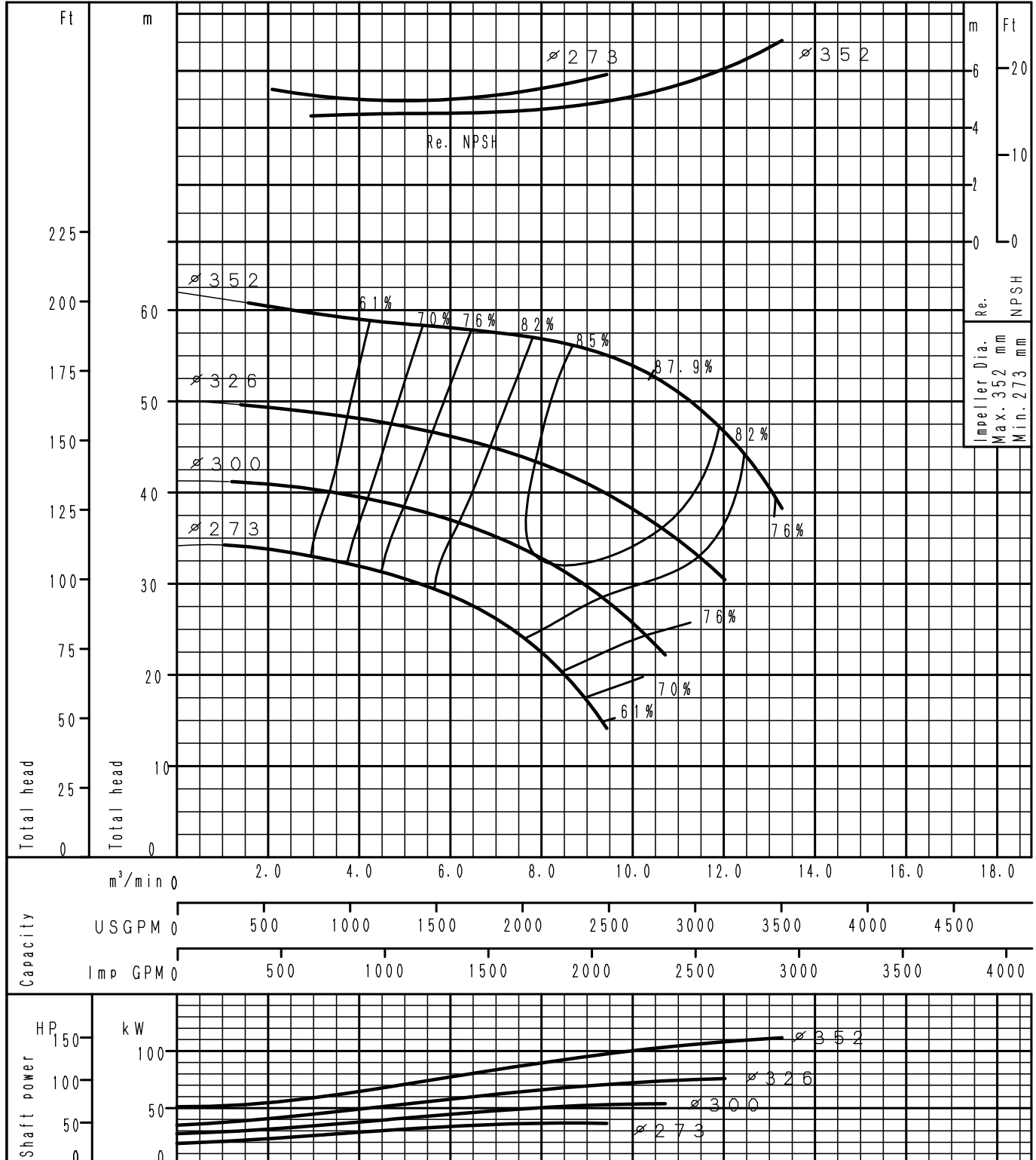



Performance Curve

4 Poles

GS150-400L	According to ISO testing code 9906 Grade 3B
60Hz ( Speed 1750 min <sup>-1</sup> )	DENSITY= 1.0 kg/l , VISCOSITY= 1.0 mPa·s

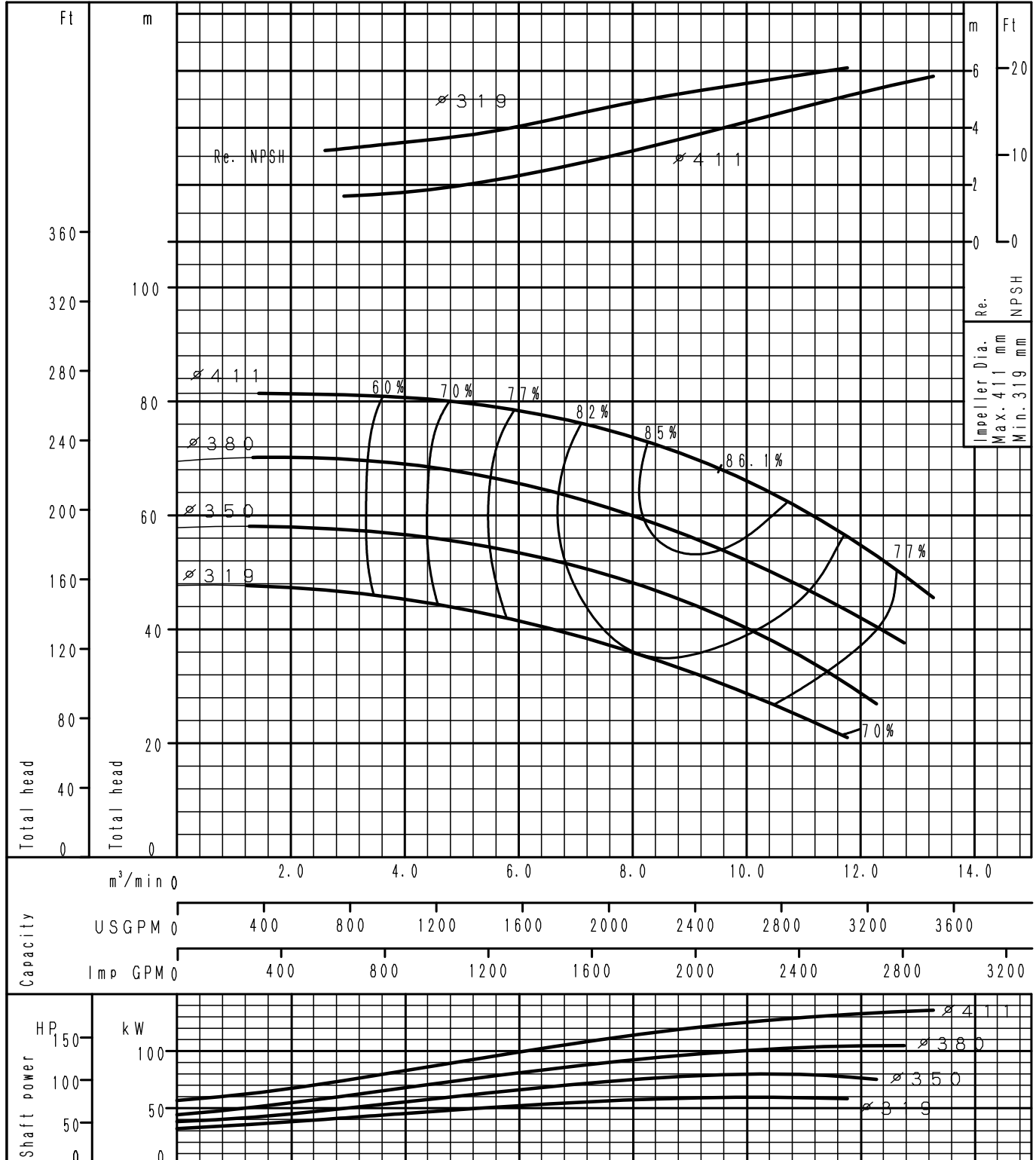

Performance Curve

4 Poles

GS150-500	According to ISO testing code 9906 Grade 3B
60Hz ( Speed 1750 min <sup>-1</sup> )	DENSITY= 1.0 kg/l , VISCOSITY= 1.0 mPa·s

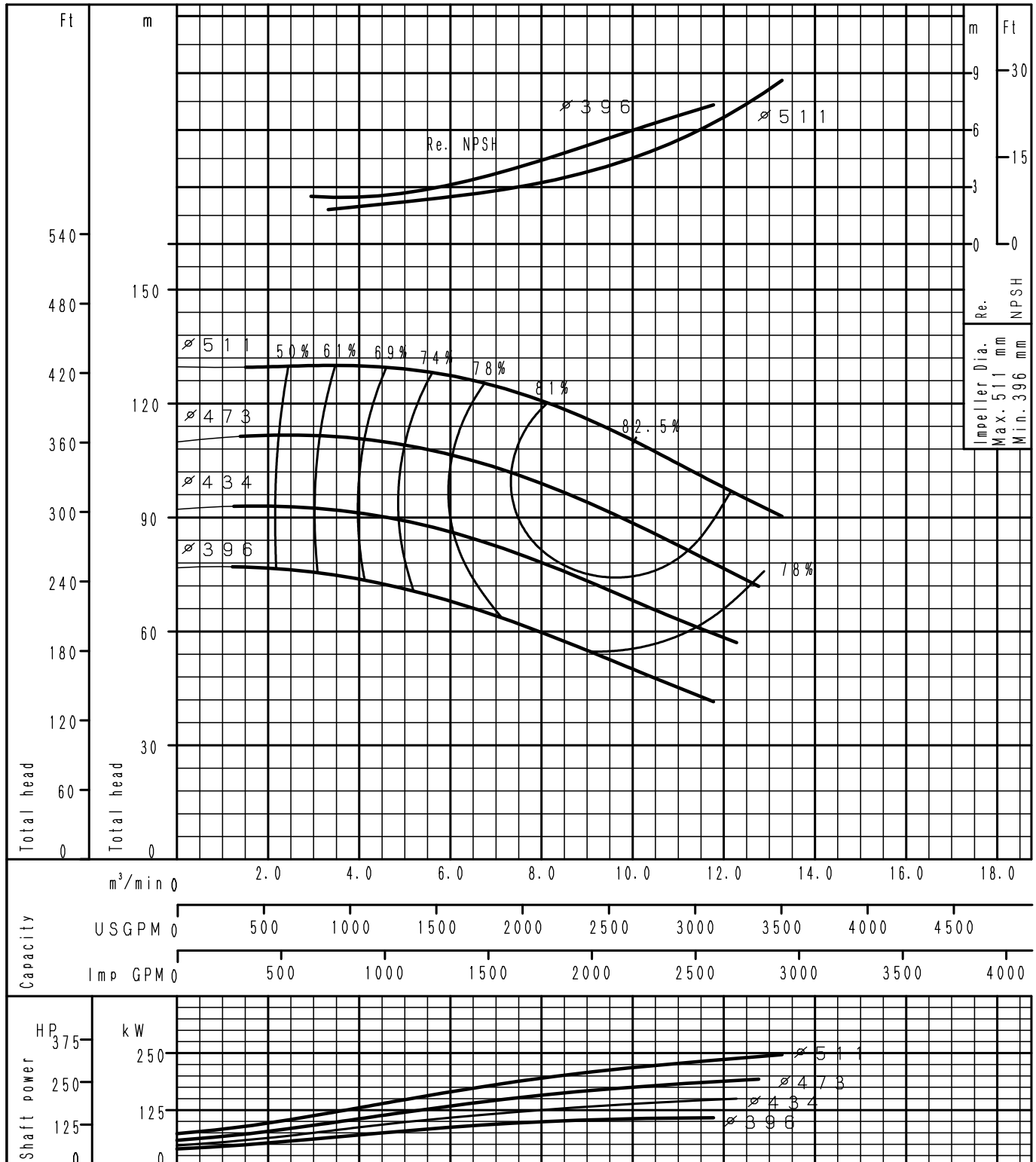

Performance Curve

4 Poles

GS200-400	According to ISO testing code 9906 Grade 3B
60Hz ( Speed 1750 min <sup>-1</sup> )	DENSITY= 1.0 kg/l , VISCOSITY= 1.0 mPa·s

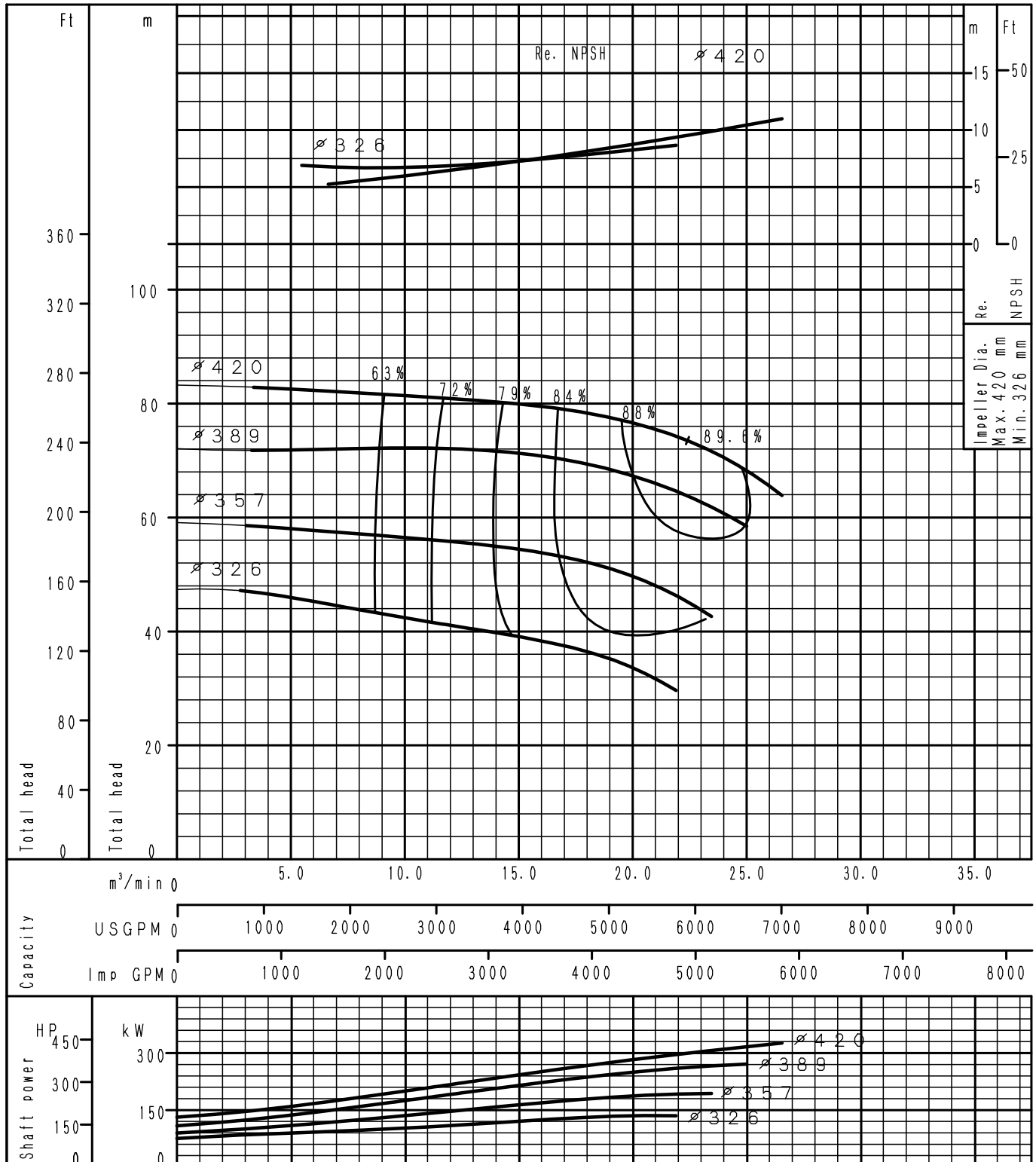

Performance Curve

4 Poles

GS200-500	According to ISO testing code 9906 Grade 3B
60Hz ( Speed 1750 min <sup>-1</sup> )	DENSITY= 1.0 kg/l , VISCOSITY= 1.0 mPa·s

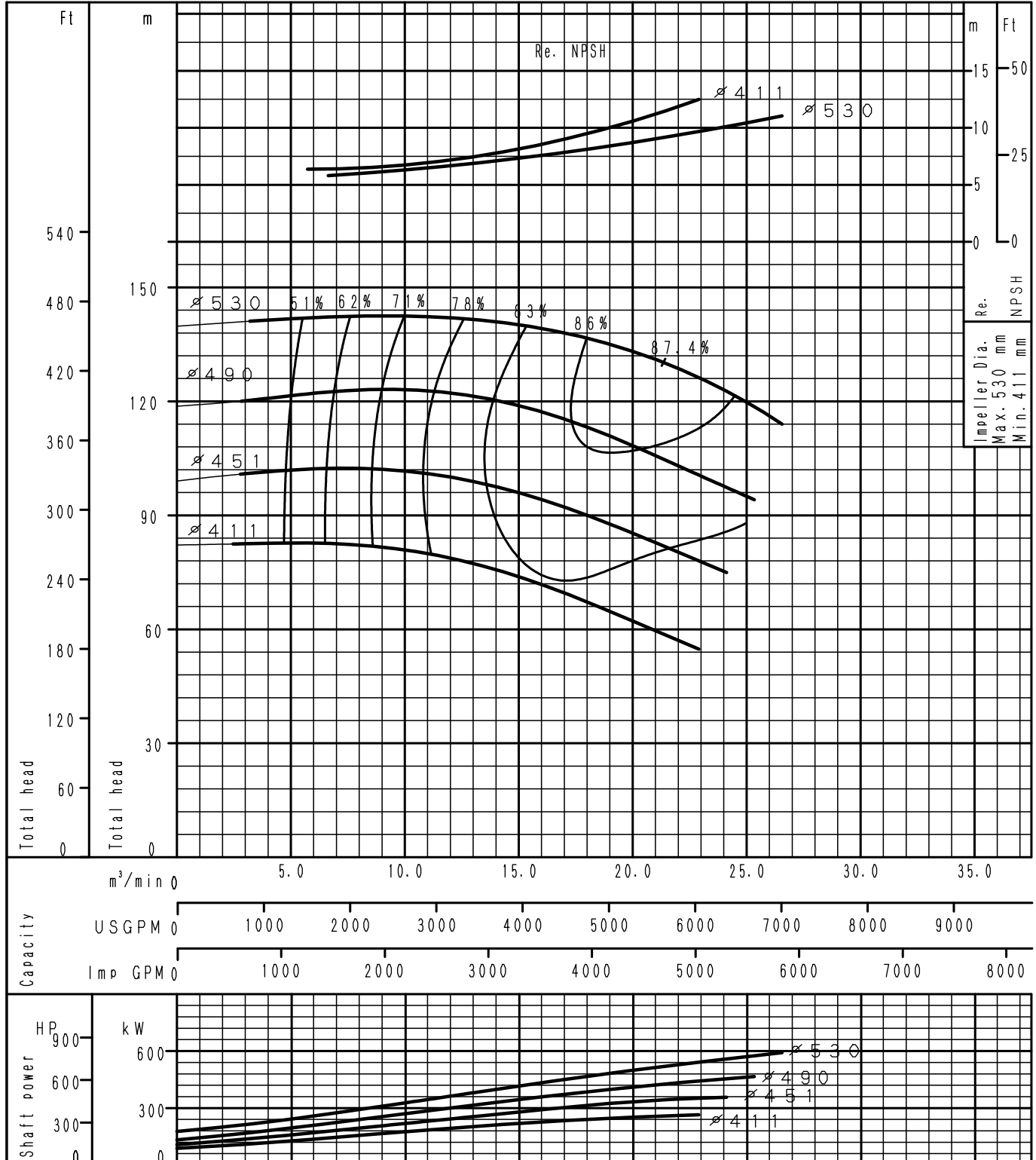



## EBARA Corporation

11-1, Haneda Asahi-cho, Ohta-ku, Tokyo, 144-8510, Japan

Phone:+81-3-3743-6111 FAX:+81-3-5736-3100

HP:<http://www.ebara.co.jp/en/>

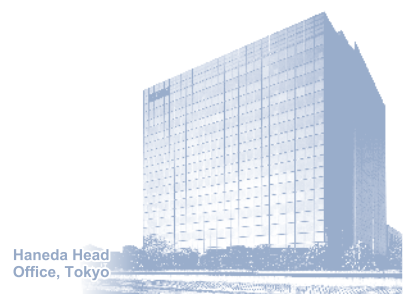

Haneda Head  
Office, Tokyo